

881/882 Video Test Instrument

User Guide



quantumdata

881/882 Video Test Instrument, User Guide, Revision A.35 (9/23/10)

Copyright 2010 Quantum Data. All rights reserved.

The information in this document is provided for use by our customers and may not be incorporated into other products or publications without the expressed written consent of Quantum Data. Quantum Data reserves the right to make changes to its products to improve performance, reliability, producibility, and (or) marketability. Information furnished by Quantum Data is believed to be accurate and reliable. However, no responsibility is assumed by Quantum Data for its use.

Updates to this manual are available at <http://www.quantumdata.com/support/downloads/>.

Table of Contents

Chapter 1	Getting Started	
	Introduction	2
	882D features	2
	Video interfaces	4
	Computer interfaces	7
	Front panel interface	9
	Status indicators	9
	Menu selection keys	10
	882 file system and media	13
	882 file system	13
	882 media	13
	882 operational modes	14
	Booting up the 882	14
	Basic mode	15
	Browse mode	15
	Web interface	20
	Working with the Virtual Front Panel	20
	Working with the CMD (Command) Terminal	22
	Working with the 882 FTP Browser	23
	Copying files between 882s	27
	Command line interface	30
	Working with the serial interface	30
	Working with the network interface	33
	Sending commands interactively	34
	Sending command files (serial interface only)	34
	Working with user profiles	36
Chapter 2	Testing Video Displays	
	General video display testing procedures	40

Making physical connection	40
Selecting interface type	41
Selecting video format	43
Selecting image	47
Testing analog computer (IT) CRTs	52
Testing digital computer (IT) FPDs	55
Testing analog composite video SDTV (CE) CRTs	58
Testing analog component video SDTV (CE) CRTs	61
Testing digital component video HDTV (CE) FPDs	64
Testing SDI and HD-SDI digital component video studio displays	69
Using the Image Caching feature	72
Using the AuxTest image	74
Using the ImageShift utility	76
Using the ImageShift utility through the front panel	76
Using the ImageShift utility through the command line interface	79
Adjust Frequency Function	81
Keypad Utility	82

Chapter 3 Administrative Tasks

Overview	86
Calibrating the generator.	87
Calibrating signal level	87
Calibrating frequency	88
Auto Upgrade	90
Auto upgrade - Network Method.	90
Auto upgrade - PCMCIA/Compact Flash Method.	97
Upgrading the generator locally	109
Manually upgrading using PCMCIA Compact Flash card.	109
Manually upgrading the generator without using PC Card.	111
Connecting generator directly to a PC	113
Reconfiguring and booting a stalled generator	119
Cloning generators	124
Cloning a generator using the PC card.	124
Cloning a generator using the Generator FTP Browser	125

Resetting a generator	128
Viewing generator configuration information.	129
Chapter 4 Networking 882s	
Overview	136
882 file system	136
Configuring a file server	137
File server specifications	137
Installing an FTP server	137
Copying resource files to the FTP site on the file server	140
Establishing a network environment	142
Connecting 882s to the network	142
Setting the 882's IP address.	143
Setting the file server IP address in the 882.	146
Network operations	148
Booting a 882 from the file server.	148
Sharing objects on a file server	149
Controlling a 882 remotely	151
Using the Virtual Front Panel to operate a 882 remotely	151
Operating the 882 remotely through the command line interface.	151
Upgrading 882s over a network	152
Upgrade options and procedures	152
Backing up the current files on the file server.	152
Copying files to the PC file server.	153
Removing current files from the 882s.	154
Copying the new files to each 882	154
Reboot the 882s	154
Cloning 882s using the 882 FTP Browser.	155
Chapter 5 Using GPIB Interface	
Overview	158
Setting the GPIB port address	159
Queries and commands	161
Commands	161
Queries.	162

Sending commands and queries	163
Status queries and control	165
Status byte	165
Bus commands	167
Chapter 6 Working with Formats	
Overview	170
Format library	171
Composite television format names	171
Component television format names	172
Computer display format names	173
Aperture designators	174
Viewing the source list of formats	176
Configuring format parameters	177
Viewing and modifying format parameters through the front panel	177
Viewing and modifying format parameters via the command line	181
Viewing and modifying format parameters by editing XML files	182
Format Editor Overview	184
Format Editor - Basic Window Configuration and Operation	184
Format Editor - Top Level Menus	185
Format Editor - Menu Buttons	187
Format Editor - New Format	188
Format Editor - New Report	209
Format Editor - New Source Menu	213
Format Editor - Open	215
Format Editor - Save	216
Creating a new format using the Format Editor	217
Creating custom formats using the command line interface	222
Format catalogs	223
Using format catalogs	223
Creating format catalogs	224
Deleting format catalogs	225
Chapter 7 Working with Images	
Overview	230

Viewing the Content list of images	231
Viewing and modifying image options	231
Viewing image versions	231
Creating custom images	234
Rendering bitmap images	237
Setting image component values	239
Creating image catalogs	241
Creating an image catalog	241
Deleting an image catalog	245
Chapter 8 Working with Test Sequences	
Overview	250
Viewing the test sequence list.	251
Viewing the test sequence list using the front panel.	251
Viewing the test sequence list using the command line interface.	251
Running a test sequence	253
Running a test sequence using the front panel	253
Running a test sequence using the command line interface	254
Creating a test sequence	256
Creating a test sequence using the command line interface	256
Editing a test sequence XML file	260
Deleting a test sequence.	263
Chapter 9 Testing HDMI Sink Devices	
Overview of HDMI display testing	266
Physical connections	266
Format selection	267
Image selection.	270
Setting up the 882 for HDMI testing	271
Selecting video format	272
Testing HDMI displays	276
Testing HDMI 1.4 displays with 3D	278
Rendering 3D images.	278
Testing HDMI video pixel repetition (882 only)	285
Testing HDMI audio	289

Testing 2-channel HDMI audio output from internal SPDIF source	289
Testing 8-channel HDMI audio output from internal source	292
Testing multi-channel compressed HDMI audio formats	296
Testing HDMI audio using an external audio source	299
Testing HDMI InfoFrames (882 only)	302
Viewing InfoFrame contents (882 only)	302
Testing with Active Format Description (AFD) (882 only)	306
Chapter 10 Testing Lipsync	
Overview	312
Testing display (sink) devices	313
Chapter 11 Testing EDID for HDMI	
Overview	320
Testing with display (sink) devices	321
Viewing EDID from a display (882 only)	321
Generating an EDID Information Report	324
Modifying EDID in a display	326
Capturing and storing EDID from display device	327
Creating or editing EDID contents	328
Testing EDID for HDMI compliance in display (sink) devices	330
Testing HDMI sink device for EDID compliance	330
Verifying pixel encoding and rate support	349
Using the EDID Editor tool	352
Loading EDIDs with the EDID Editor	352
Editing an existing EDID	356
Creating a new EDID	359
Saving an EDID to a file	368
Putting (Writing) EDID to a display	369
Emulating an EDID	370
Running an EDID HDMI compliance test	371
Running an EDID data report	372
Using the EDID Compare tool	374
Comparing EDIDs	374

Chapter 12	Testing HDCP on HDMI	
	Overview	378
	Testing DVI displays with HDCP	379
	Testing HDMI displays with HDCP	381
	Running HDCP test in step mode	384
	Running an HDMI HDCP self-test	386
	Understanding the HDCP test	387
	HDMI HDCP test sequence:	387
Chapter 13	Using Special Sync Output	
	Overview	390
	Operating special sync for probe pulse	391
	Probe coordinate numbering	391
	Configuring the probe feature	391
	Controlling the probe using the command line interface	394
	Configuring special sync for FS, LS, or CS	395
Chapter 14	Script SDK	
	Overview	398
	Installation	398
	Image programs versus script programs	399
	Creating executable program scripts	400
	Getting Started	400
	About the ScriptSDK main window	401
	ScriptSDK menu summary	402
	Starting ScriptSDK	404
	Creating, compiling, and executing a script	405
	ScriptSDK API functions by category	409
	Control functions	409
	Command functions	409
	Response functions	410
	Front panel functions	410
	Operator functions	410
	ScriptSDK API functions by name	411
	ScriptSDK commands	439

Sample ScriptSDK programs	446
Commands by category	466
System	466
GPIB (IEEE-488.2 standard)	468
Gating Controls	468
Images	469
Formats	471
Test Sequences	477
Directories	478
EDID and DDC	478
Special Sync Probe Pulse	480
Color Look-Up Table (LUT)	480
HDMI	480
HDCP	481
DVI/HDMI DisplayPort Signal Analyzer	481
Commands by name	482
Standard image descriptions	824
Error code descriptions	930
0000-0099 General errors	930
2000-2999 Format errors	930
3000-3999 Image errors	945
4000-4999 Test sequence errors	946
5000-5999 Directory errors	948
6000-6999 Bitmap errors	948
7000-7999 LUT errors	949
8000-8999 Font errors	949
9000-9999 System errors	950
10000-10999 System errors	955
SDTV Formats	959
HDTV Formats	962
VESA DMT Formats	963
VESA CVT Formats	964
Game Formats	968

Medical Formats	969
Military Formats	970
TTL Formats	970
Misc. Formats	971
Test Formats	971
Manufacturer Associated Formats	972

1 Getting Started

Topics in this chapter:

- [Introduction](#)
- [Video interfaces](#)
- [Computer interfaces](#)
- [Front panel interface](#)
- [882 file system and media](#)
- [882 operational modes](#)
- [Web interface](#)
- [Command line interface](#)
- [Working with user profiles](#)

Introduction

This User's Guide describes the features, functions and operating procedures for the 881 and 882 Quantum Data video test instruments for testing analog and digital video display devices. The 881 provides features for testing video displays in production environments. The 882 is its complement. It provides extended features to test video displays for development environments and quality assurance applications.

There are three versions of the 882: 1) the 882C (and CA which includes the analyzer) and 2) the 882D and 3) 882E. The 882C provides two HDMI output ports (and two HDMI input ports if the analyzer option is present), a composite video and S-video connector and a VGA connector. The 882D provides a single HDMI output connector, a dual link DVI-I connector and a composite video and S-video connector. The SDI/HD-SDI outputs are an option for either the 882C or the 882D. The 882D does not support the analyzer option. The 882E provides either HDMI outputs and inputs or a DisplayPort output and input.

882D features

- HDTV ready—Pre-programmed standard DTV formats are ready for immediate use. Digital outputs support YCbCr color encoding. Analog outputs support tri-level composite sync and YPbPr.
- Built-in formats—Over 350 popular video formats are built-in including VESA, ATSC, EIA-770.x, SMPTE 170, 240, 259, 267, 274, 292, 293, 295, 296, Australian, EIA/CEA-861C, NTSC and PAL.
- Central administration—Update and configure all networked instruments from a single computer.
- Network control—Fully control instrument from any network location with web browser or Telnet client.
- Graphics SDK—Create complex patterns based on your specifications using C++ software development kit.
- HDMI—Full single-link HDMI 1.2a. DVI. HDCP production keys for HDMI output.
- DVI—Full dual-link. HDCP production keys for HDMI output.
- Easy to use—Access powerful features easily using intuitive user interface.
- Multiple configurations—Save and restore different instrument configurations for different applications.
- Local pattern storage—Store multiple custom images (.bmp, .jpg, and .png) images in instrument.
- Self-calibrating—Analog video outputs are automatically adjusted against an internal precision reference. This assures video levels that are precise and reliable. Signal levels are auto-adjusted individually.

- 400 MHz analog pixel rate—Programmable precision RGB, YPbPr.
- Probe—Trigger a scope or inspection camera using the probe signal. Position a pulse anywhere in the frame.
- PC Card—Clone one 882 to another using a standard CompactFlash card.
- HDMI transmitter features:
 - Advanced E-EDID parsing
 - High-level Active Format Description (AFD) controls
 - AFD test suite
 - Pixel repetition test suite
 - Automatic and manual InfoFrame setup
 - Internal sine wave 882, and external SPDIF audio input
 - 32, 44.1, 48, 88.2, 176.4 and 192kHz audio sampling rates
 - Generates all EIA/CEA-861D formats below 165 MHz, with all possible variations
 - Complete letterbox and scope coverage
 - 4:2:2 color sub-sampling at 8, 10, and 12-bits per component
 - Hot-plug format list
- Includes two (2) DVI-D (M) to HDMI (M) cables, VGA to RCA cable, and HDMI-HDMI cable.
- TV—CVBS and S-video outputs.
- IEEE-488-GPIB (IEEE-488) interface. interface.
- RS-232-Industry standard serial interface.

882D Optional Features

The following are the optional features available with the 882D.

- SD/HD-SDI—Single link
 - 1.485Gb/s and 1.485/1.001Gb/s
 - YCbCr
 - 4:2:2 color sub-sampling at 10-bits per component

Video interfaces

This section describes the 882's video interfaces.

The video interfaces on the 882D are shown below.

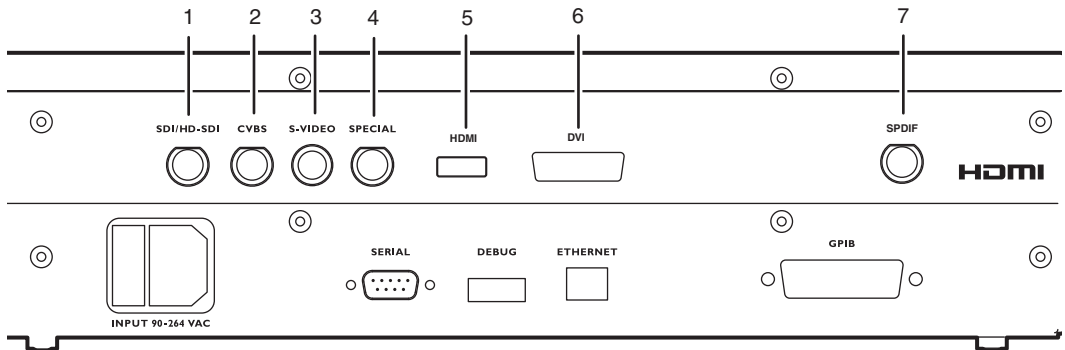

Interface	Description
1	SDI/HD-SDI connector outputs a serial digital signal per SMPTE 259M and SMPTE 292M standards.
2	CVBS connector outputs an analog composite video baseband signal in accordance with SMPTE 170M standard.
3	S-VIDEO connector outputs an S-Video split luminance (Y) and chrominance (C) analog video signal.
4	SPECIAL connector provides multiple outputs, including: <ul style="list-style-type: none"> digital composite sync line sync frame sync movable scope trigger (probe) pulse pixel clock signal
5	HDMI OUT connector outputs full single link HDMI video, as well as DVI and modern HDMI-compatible digital video signals.
6	DVI connector outputs full dual link HDMI video.
7	SPDIF connector inputs audio from an external source.

VGA interface

The VGA interface, available on the model 882C generator, outputs analog video for testing analog video displays. The following table describes the VGA connector pinouts.

Pin	Signal	Pin	Signal	Pin	Signal
1	Analog Red Video	6	Analog Red Video Ground	11	No Connection
2	Analog Green Video	7	Analog Green Video Ground	12	DDC/EDID Serial Data

Pin	Signal	Pin	Signal	Pin	Signal
3	Analog Blue Video	8	Analog Blue Video Ground	13	Horizontal Sync
4	No Connection	9	DDC/EDID +5 Vdc Out	14	Vertical Sync
5	Digital Ground	10	Digital Ground	15	DDC/EDID Data Clock

DVI-I interface

The DVI-I interface, available on the model 882D generator, outputs digital video for testing DVI-compliant video displays. The DVI-I connector also provides an analog output which can be used to test analog formats.

The DVI connector pinouts are shown in the following table.

Pin	Signal	Pin	Signal	Pin	Signal	Pin	Signal
1	TMDS D2-	9	TMDS D1-	17	TMDS D0-	C1	Analog Red
2	TMDS D2+	10	TMDS D1+	18	TMDS D0+	C2	Analog Green
3	D2/4 Shield	11	D1/3 Shield	19	D0/5 Shield	C3	Analog Blue
4	TMDS D4-	12	TMDS D3-	20	TMDS D5-	C4	Horizontal Sync
5	TMDS D4+	13	TMDS D3+	21	TMDS D5+	C5	Analog Ground
6	DDC Clock	14	+5 Vdc	22	Clock Shield		
7	DDC Data	15	Ground	23	TMDS Clock+		
8	No Connection	16	Hot Plug Detect	24	TMDS Clock-		

HDMI interface

The HDMI interface emulates an HDMI-compliant video display. The HDMI connector pinouts are shown in the following table.

HDMI Type A Connector Pinouts

Pin	Signal	Pin	Signal	Pin	Signal
1	TMDS Data 2+	7	TMDS Data0+	13	CEC
2	TMDS Data2 Shield	8	TMDS Data0 Shield	14	Reserved (N.C.)
3	TMDS Data2-	9	TMDS Data0-	15	SCL
4	TMDS Data1+	10	TMDS Clock+	16	SDA
5	TMDS Data1 Shield	11	TMDS Clock Shield	17	DDC/SEC Ground
6	TMDS Data1-	12	TMDS Clock-	18	+5 V Power
				19	Hot Plug Detect

Special Sync interface

Use the Special connector to output frame sync, line sync, composite sync, or a special probe pulse. For more information, see Chapter 13, "[Using Special Sync Output](#)."

S-Video interface

The 882 generator has an S-Video connector labeled "S-VIDEO." This is a miniDIN connector that emulates an S-Video compliant source for outputting composite TV signal.

Composite video BNC

The 882 generator has a composite TV BNC connector labeled "CVBS." This interface emulates an analog composite TV source.

Computer interfaces

This section describes the 882's computer interfaces. The computer interfaces are shown below (882C shown).

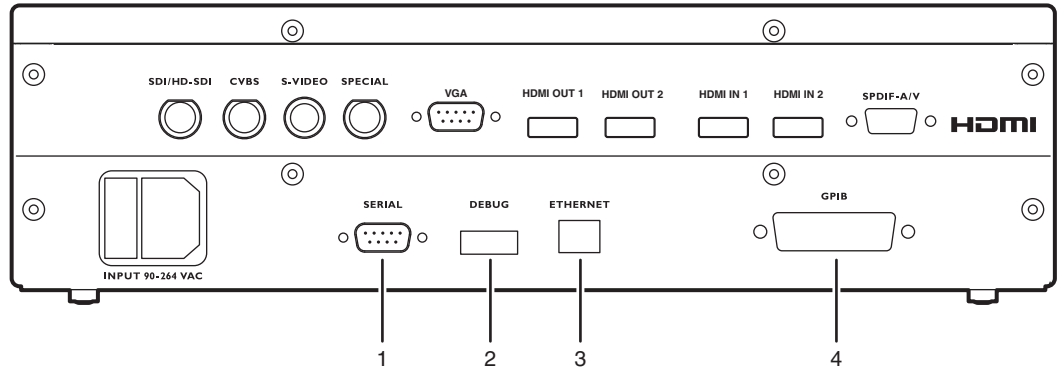

Connector	Description
1	SERIAL connector provides RS-232C serial data communication interface for the 882.
2	DEBUG connector is for Quantum Data use only.
3	ETHERNET connector is used to connect the 882 with a TCP/IP network, for remote administration and control, and for sharing resources from a file server.
4	GPIB connector provides IEEE-488 GPIB interface to the generator (882 only; not provided on 881 generators).

RS-232 interface

Each 882 has a standard RS-232 serial connector, labeled “SERIAL.” This is a 9-pin D-Sub male connector which enables you to connect the 882 with a computer. A null modem cable is provided to support this interface. You can communicate with the 882 through the command line interface using a terminal emulator such as HyperTerminal. For more information, see [“Working with the serial interface”](#) on page 30. The pinouts for the RS-232 connector are shown in the following table.

Pin	Signal	Pin	Signal	Pin	Signal
1	Data Carrier Detect	4	Data Terminal Ready	7	Request to Send
2	Received Data	5	Signal Ground	8	Clear to Send
3	Transmitted Data	6	Data Set Ready	9	Ring Indicator

GPIB interface

The GPIB interface allows you to use the 882 as a programmable video signal source in a larger automated test system. The GPIB connector pinouts are listed in the following table.

Pin	Signal	Pin	Signal	Pin	Signal	Pin	Signal
1	DIO1	7	NRFD	13	DIO5	19	Shield
2	DIO2	8	NDAC	14	DIO6	20	Shield
3	DIO3	9	IFC	15	DIO7	21	Shield
4	DIO4	10	SRQ	16	DIO8	22	Shield
5	EOI	11	ATN	17	REN	23	Shield
6	DAV	12	Shield	18	Shield	24	Signal Ground

Front panel interface

This section describes the front panel interface for operating the 882. The front panel keys are shown below.

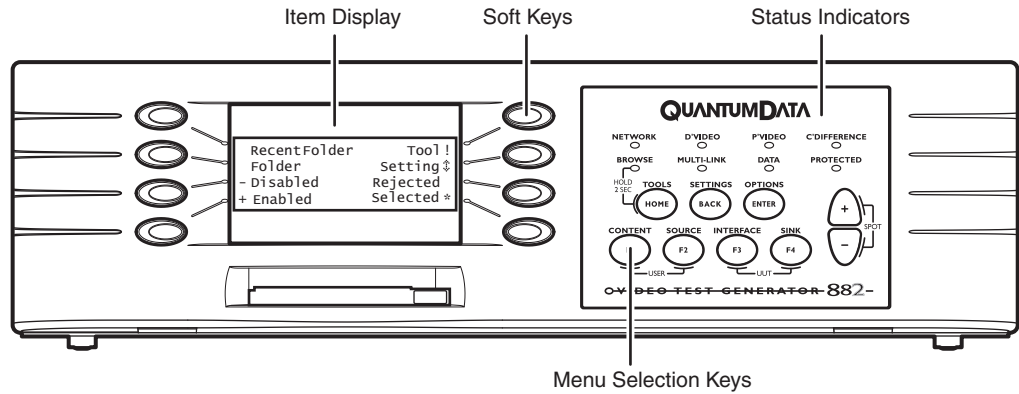

Status indicators

Status indicators provide feedback about the operational status of the 882. The graphic below shows the location of the status indicators.

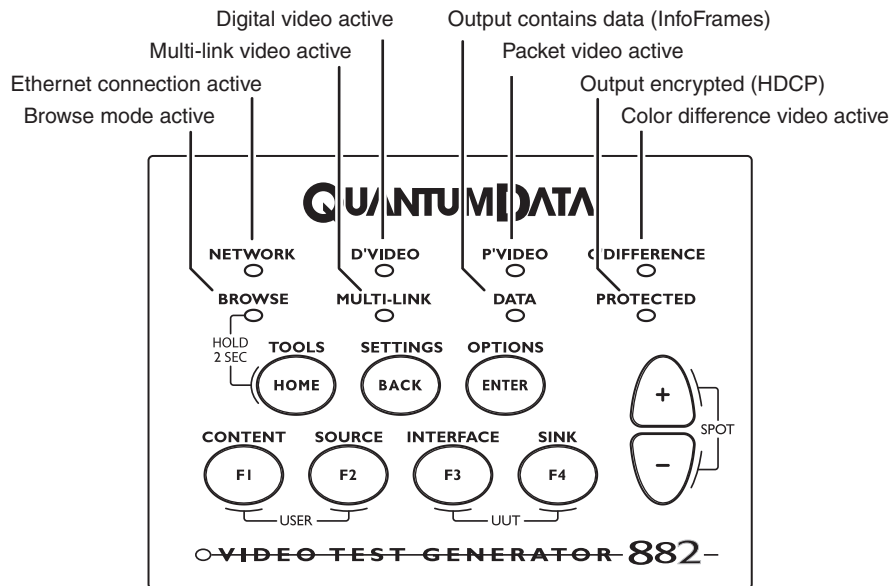

Menu selection keys

You can access the 882's menus using the menu selection keys depicted below.

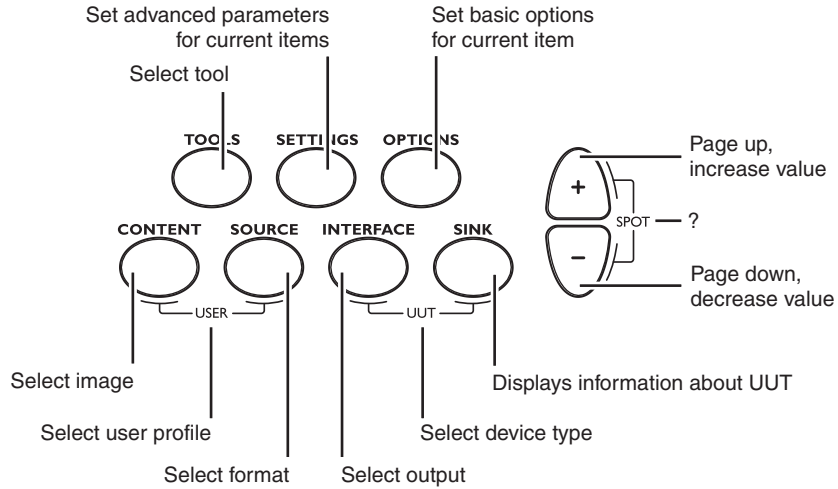

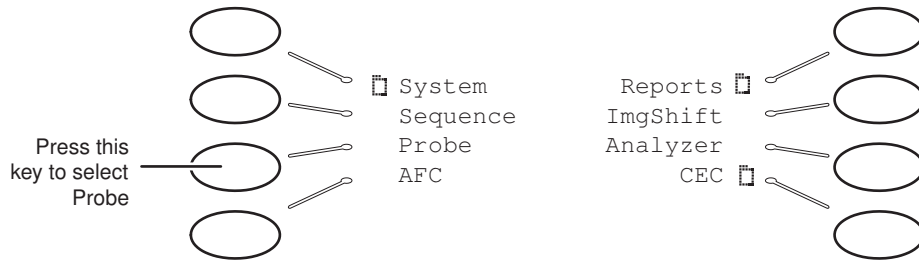

Selecting menu items

When you press a menu selection key, a menu appears on the 882's display. Each menu item corresponds to a key located adjacent to the item. These keys are called "soft keys" because their functions change depending on the items that appear on the 882's display. For example, for the menu shown below, the soft key at the upper left corresponds to the System item on the 882's display.



Pressing a soft key either selects an item, enables or disables the item, or causes additional information about the item to appear on the 882's display. An icon located next to an item provides additional information about the item. Following is a list of icons and their meanings.

Icon	Meaning
	Folder containing related items.
	Recently visited folder.

means that DSS is selected, the + sign next to SyncOnG means that this option is enabled, and the - signs next to Pedestal, SyncOnR, and SyncOnB mean that these options are disabled. If you press the soft key adjacent to SyncOnR, the - will change to a +, indicating the option is now enabled.

ACS	SyncOnR-
DCS	SyncOnG+
*DSS	SyncOnB-
-Pedestal	

The **Settings** key enables you to view or set a parameter to a value. For example, the screen below shows the settings for the video signal of a format. To change the value of the XVSI, AVSI, or DVSI setting, press the soft keys next to the arrows on the bottom row of the 882's display until the blinking cursor is on the value you want to change. Increment the value up or down by pressing the + and - keys.

	Video Signal	->	
	Interface	->	
	XVSI	AVSI	DVSI
<-	1	3	0 ->

To see other settings for the format, press the soft key adjacent to the arrows. If you press the soft key next to the arrow by Video Signal, you will see the settings for Video Timing. If you press the soft key next to the arrow by Interface, you will see the settings for Synchronization.

882 file system and media

The 882 has a file system comprised of a System folder and a Library folder of resource files that can be stored on multiple media (storage devices or locations). The files in the file system are briefly described below.

882 file system

The 882 generator file system is comprised of two main directories (folders): 1) System and 2) Library. The System folder contains the realtime operating system and firmware file (vxWorks) and the gateway. The Library folder contains the following resource files:

- Fonts - Object files used to define the font types.
- Formats - XML files defining the format parameter settings.
- FormatLib - XML files for configuring the source list of formats
- Images - C++ object files, executables, bitmaps, and XML files for rendering images.
- ImageLib - XML files for configuring the content list of images
- Sequences - XML files with instructions for test sequences.
- Users - XML files for user configuration profiles

882 media

The 882 provides for two read/write local storage media and one server-based medium (storage locations):

- Flash memory
- PCM CIA card
- Host server

Each of these storage locations contains or can contain all the 882's System and Library files.

882 operational modes

The 882 has two operational modes: 1) Basic mode and 2) Browse mode. The 882 boots up in the Basic mode which is the main operating mode you will be using. Both modes are described below along with instructions for booting up the 882.

Booting up the 882

When the 882 is powered up it presents a screen enabling you to select the boot device. The 882 loads its operating system and firmware from a from the selected boot device or specified medium (storage location). If you do not press a key within 5 seconds the currently specified boot location is used and boot up proceeds. This feature enables you to control where the 882 boots from in instances where the default location is either inaccessible or known to have a suspect application file. Follow the procedure below to boot the 882:

To boot the 882:

1. Apply power to the 882. The following display appears.

If you are sure you want to boot from the current storage location you can let the system boot automatically.

```
Quantum Data
windriver
vxWorks System Boot
Press any key for setup
```

- a. To boot from an alternative device, press any key within five seconds. The following screen appears on the 882's display:

```
!BootDev    !Passwd
!HostName   !Flags
!FileName   !Other
!InetAddr   !TrgtName
```

2. Choose the **!BootDev** item by pressing the adjacent soft key.

```
Network Boot
* Internal Flash
PCMCIA Boot
```

3. Do one of the following:
 - To boot from the file server, press the soft key adjacent to **Network Boot**.
 - To boot from the 882's flash memory, press the soft key adjacent to **Internal Flash**.

- To boot from the 882's PC card, press the soft key adjacent to **PCMCIA Boot**.
4. Press the **Options (Enter)** key to save the configuration.
 5. Either restart the 882 by cycling the power or press the **Tools** key to return to the boot menu.
 6. Scroll down to allow viewing and selection of the BootNow item as shown below.

!FileName	!Other
!InetAddr	!TrgtName
!HostAddr	BootNow
!User	

7. Select **BootNow** by pressing the adjacent item selection key.
8. The following display appears:

Press UP arrow to Boot Now

9. Press the + key to boot the 882.

Basic mode

The Basic mode is the main operating mode of the 882. Typically, you will use the Basic mode when testing displays and sources. In Basic mode you can select formats and images, create and run test sequences, view and edit object properties, and so on.

In the Basic mode you make selections in the front panel with the item selection keys and the soft keys. The function of the menu selections key is described and depicted in "[Menu selection keys](#)" on page 10.

Browse mode

Browse mode is for advanced users who want to load objects from different media and program the 882 function keys. This mode is for expert users only.

When in Browse mode, the selection keys shown below are active.

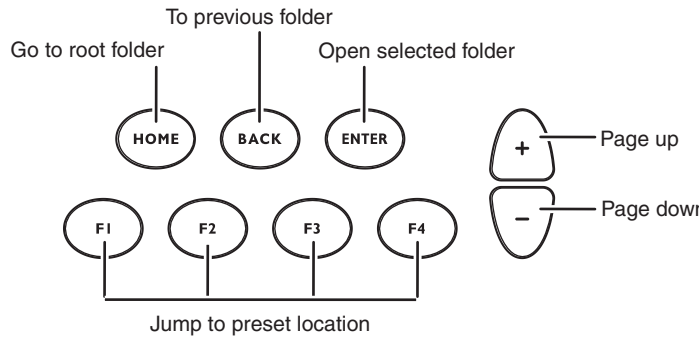

The procedure below describes how to place the 882 in Browse mode:

To place the 882 in Browse mode:

Press and hold the **Tools** key. The message **Hold to enter Browse Mode** appears on the 882's display. Continue holding the Tools key until the Browser status indicator lights. The following menu appears:

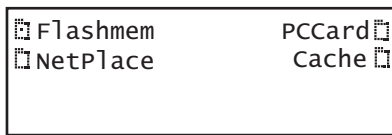

Browsing other media

In Browse mode, you can view and use objects located in the 882's flash memory, a network file server, the 882's PC card, or the 882's cache memory.

To choose the medium to browse:

1. Press the soft key adjacent to the medium you want to browse.

Medium	Description
Flashmem	Non-volatile memory in 882.
NetPlace	File server connected with 882.
PCCard	Compact Flash card in 882.
Cache	Volatile memory in 882. This source contains objects that have been used (loaded into cache) since the 882 was started.

A list of folders on that medium appears on the 882's display as shown below.

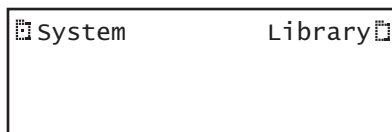

2. Choose the folder you want to open by pressing the adjacent soft key. The contents of the folder appears on the 882's display. If you need to return to the previous menu list press the back (settings) key.

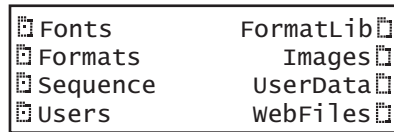

3. Continue selecting folders to open until you locate the item you need. To use an item, press the adjacent soft key.

Setting the 882's path

The 882 can be set to access format, image, and sequence files stored on its flash memory, PC card, or on a file server. To do this, you must set the 882's path to point to the corresponding folders on the desired medium. You can set the path using the command line interface or the front panel.

To set the 882's path using the front panel:

1. Place the 882 in Browse mode by holding down the **Tools** key until the media menu appears on the 882's display as shown below.

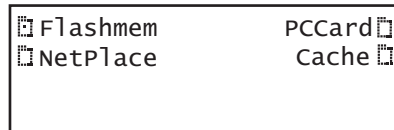

2. Choose the desired medium by pressing the adjacent soft key. The folders on the selected medium (for example flash memory) appear on the 882's display as shown below.



3. Press the soft key adjacent to the Library folder. The contents of the selected folder appears on the 882's display as shown in the example below.

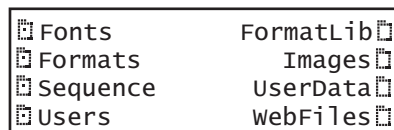

4. Press the soft key adjacent to the folder you want to use. For example, to set the format path, press the soft key adjacent to Formats. The contents of the Formats folder appears on the 882's display.

5. Select a format by pressing the adjacent soft key. The format path is now set to the selected folder on the selected medium.

To set the 882's path using the command line interface:

1. Establish a session with the 882 using either HyperTerminal over a serial connection or Telnet over an Ethernet LAN. See “[Establishing a terminal session with the 882](#)” on page 30 or “[Establishing a Telnet session with the 882](#)” on page 33.
2. For each file type (format, image, and sequence), set the path parameter to the corresponding folder on the desired medium. In the command syntax, specify the medium as follows:
 - Flash memory: `tffs0` (TFFS - Transaction Flash File System)
 - PC card: `card0`
 - File server: `<server name>`
3. For each file type (format, image, and sequence), set the path parameter to the corresponding folder on local 882 media using the following commands:

```
FMTM /medium/Library/Formats  
IMGP /medium/Library/Images  
SEQP /medium/Library/Sequences
```

For example the medium name for the PC card is `/card0`. So you would enter the following command to set the image path to the image directory on the PC card:

```
IMGP /card0/Library/Images
```

The 882 will now display the images on the PC card when you press the **Contents** key.

The medium name for the flash memory is `/tffs0`. So you would enter the following command to set the image path to the format directory on the flash memory:

```
FMTM /tffs0/Library/Formats
```

The 882 will now display the formats on the flash memory when you press the **Source** key.

The medium name for the network is the server (host name) memory. So you would enter the following command to set the image path to the format directory on the flash memory:

```
SEQP /Server030/Library/Sequences
```

The 882 will now display the sequences on the server when you press the **Tools** key and then select sequences.

Programming the 882's function keys

The 882 is equipped with four function keys (F1 through F4) that can be programmed as shortcuts to folders. The procedure below describes how to program the function keys.

To program a function key as a folder shortcut:

1. Browse to the folder to which you want to create a shortcut.
2. Hold down a function key (F1, F2, F3, or F4) to assign the key to the folder.

Switching from Browse mode to Basic mode

To switch from Browse mode to Basic mode:

Press and hold the **Tools** key. The message **Hold to enter Basic Mode** appears on the 882's display. Continue holding the Tools key until the Browse Mode status indicator turns off and the Tools menu appears.

System	Reports
Sequence	ImgShift
Probe	Analyzer
AFC	CEC

Web interface

The 882 has a built-in Web server that enables you to interact with the 882 using a PC and an Ethernet connection. The Web interface includes the following functions:

- Format Editor for creating formats and modifying and viewing format parameters. For more information about the Format Editor, see “[Creating a new format using the Format Editor](#)” on page 217.
- Virtual Front Panel for operating the 882 remotely.
- CMD Terminal for operating the 882 using the command line interface.
- 882 FTP Browser for copying files between media within the 882, between 882s, and between a 882 and a PC.
- Calibration reports (Currently not available)

This section describes how to operate the Virtual Front Panel, CMD Terminal, and the 882 FTP Browser.

Working with the Virtual Front Panel

The Virtual Front Panel enables you to perform remotely the same tasks as you would with the 882’s front panel. To use the Virtual Front Panel, you must have a PC connected to a 882 either through an Ethernet LAN or locally through an Ethernet crossover cable connected between the Ethernet ports on the 882 and the PC. These configurations are described in more detail in “[Establishing a network environment](#)” on page 142. You must also have the Java Runtime Environment (JRE) 1.5 or later installed on your PC. You can download the JRE from http://www.java.com/en/download/windows_ie.jsp.

To use the Virtual Front Panel, you must know the IP address of the 882. The following procedures describe how to determine the 882’s IP address and how to access the Virtual Front Panel using a Web browser.

To determine the IP address of the 882:

1. Press the **Tools** key. The Tools menu appears on the 882’s display as shown below.

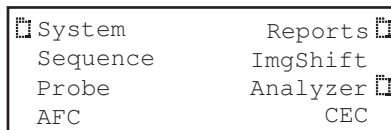

- Choose the **System** item by pressing the adjacent soft key. The System menu appears on the 882's display as shown below.

Clock	Clone*
CalFactor	Server
Network	About
Serial	GPib

- Choose the **Network** item by pressing the adjacent soft key. The 882's IP address appears on the 882's display as shown below.

IP Address
192.168.254.001
Subnet Mask
255.255.255.000

To use the Virtual Front Panel:

- Open a Web browser (such as Internet Explorer) and type the 882's IP address in the address entry field. For example, enter the following: http://192.168.254.001.

The 882 home page appears in the browser.

HOME

quantumdata

VIRTUAL VIDEO DISPLAY

Click Here

Tools

- Format Editor
- Virtual Display
- FTP Browser
- CMD Terminal
- Auxiliary Channel Analyzer
- EDID Compare Tool
- SAM+
- EDID Editor
- CEC Controller
- Generated Reports



Java is a trademark of Sun Microsystems, Inc.

Note: You can add the page to your list of favorite pages in your Web browser to avoid retyping the IP address each time you want to access the page.

2. Click the **Virtual Front Panel** link. The Virtual Front Panel appears.

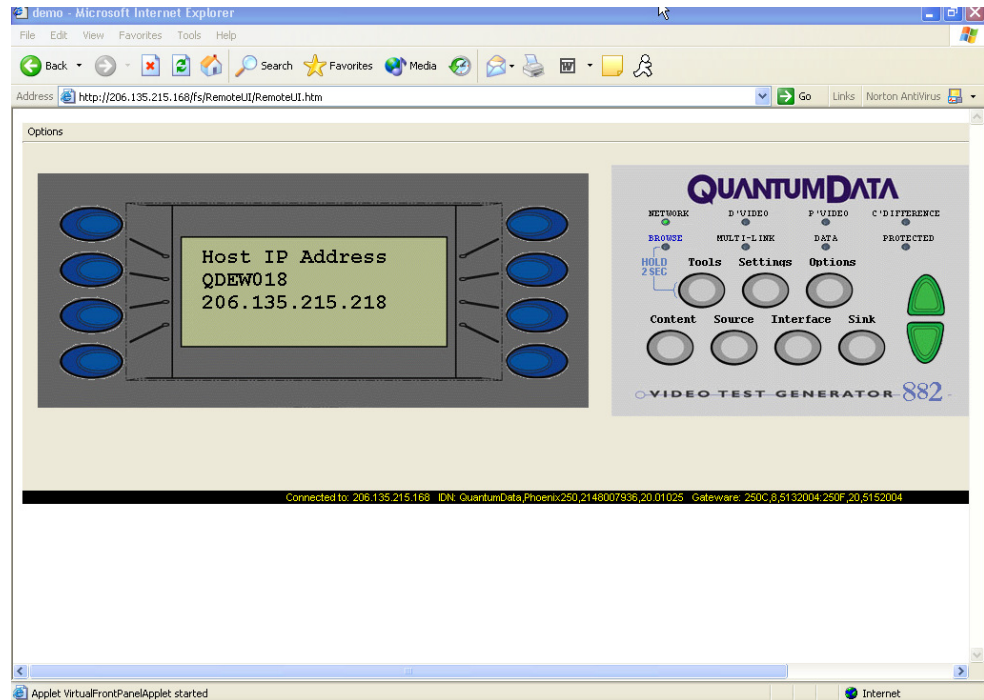

3. Use your mouse to click the virtual keys, which function the same as if you pressed the physical keys on the 882.

Working with the CMD (Command) Terminal

The CMD Terminal allows you to send commands to the 882 using the command line interface.

To use the CMD Terminal:

1. Access the Virtual Front Panel page. See [“To use the Virtual Front Panel:”](#) on page 21.
2. Click the **CMD Terminal** link. The CMD Terminal window appears.

3. In the box at the top of the CMD Terminal window, enter a command, and then press Enter. The command appears in the lower pane.

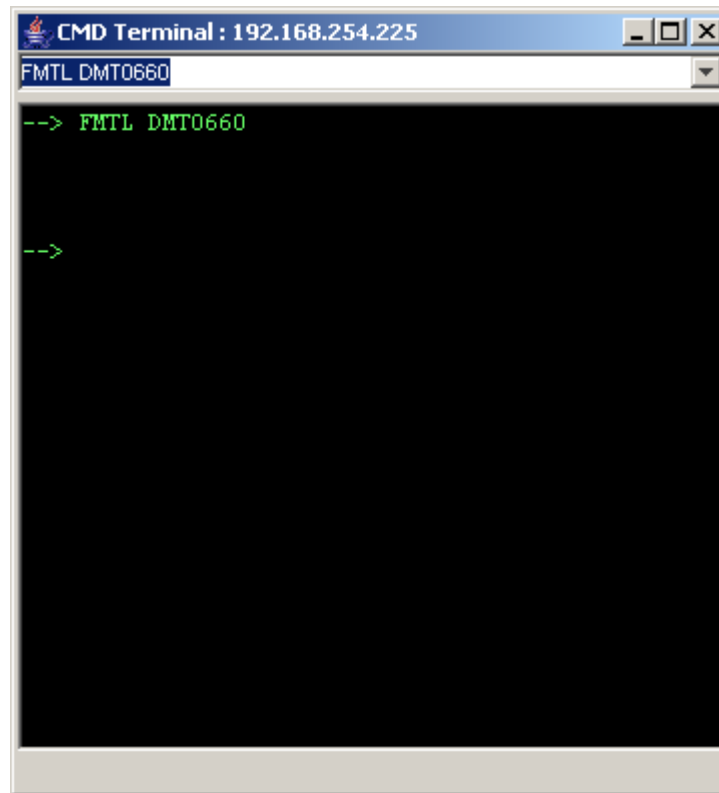

Working with the 882 FTP Browser

If you create objects on a PC, such as images or formats, you can use the 882 FTP Browser to copy these objects to a 882. You can also use the 882 FTP Browser to copy objects between media in a 882 and to copy objects from one 882 to another.

Copying files from a PC to a 882

To copy files from a PC to a 882:

1. Access the 882's FTP browser by choosing the **FTP Browser** menu item from the main web page. The 882 FTP Browser appears. The Instrument Files area

2. shows the files stored on the 882. The Host Files area shows the files stored on the PC.

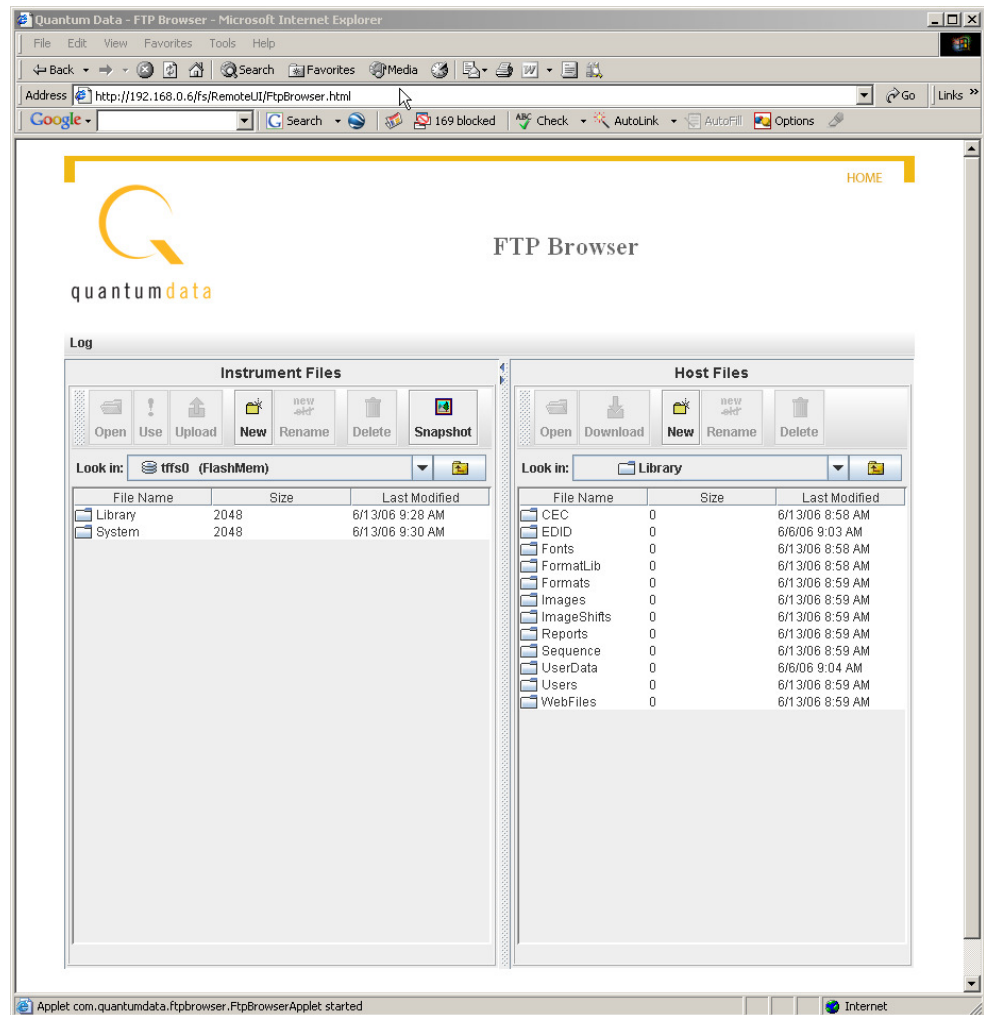

3. In the **Host Files** area, locate and select the file or folder you want to copy.
4. In the **Instrument Files** area, locate the destination folder for the file as follows:
 - a. In the **Look in** box, click the down arrow and select the medium where you want to copy the file. Select **tffs0** for the 882's flash memory or **card0** for the 882's PC card.
 - b. In the list of files, open the destination folder.
5. In the **Host Files** area, click **Download**. The **Transfer Files** dialog box appears.
6. Verify that the source file or folder and the destination folder are correct, and then click **OK**.
7. The **Copying Files** dialog box appears showing the status of the operation. When the status is 100%, click **Done**.

Copying files from a 882 to a PC

To copy files from a 882 to a PC:

1. Access the 882's FTP browser by choosing the **FTP Browser** menu item from the main web page. The 882 FTP Browser appears. The Instrument Files area shows the files stored on the 882. The Host Files area shows the files stored on the PC.

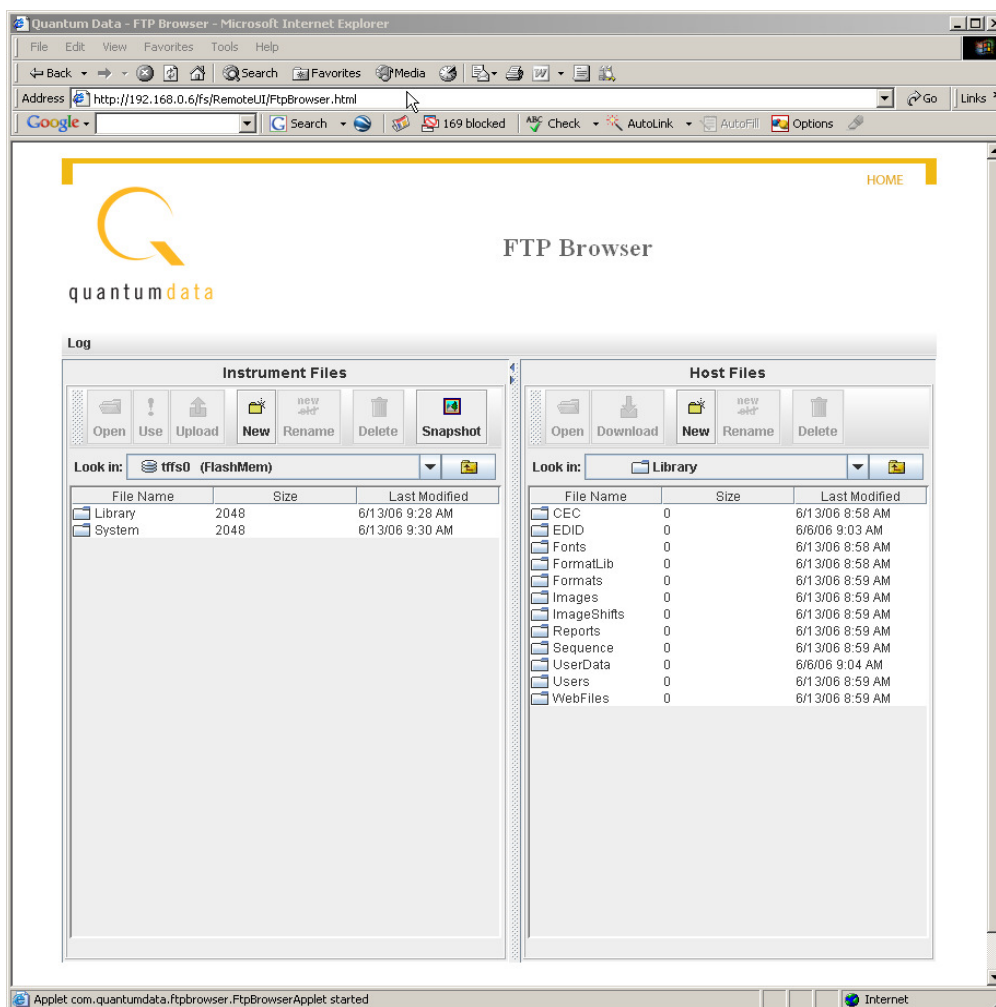

2. In the **Instrument Files** area, locate and select the file or folder you want to copy as follows.
 - a. In the **Look in** box, click the down arrow and select the medium where the file is located. Select **tffs0** for the 882's flash memory or **card0** for the 882's PC card.
 - b. In the list of files, select the file or folder you want to copy.
3. In the **Host Files** area, open the destination folder where you want to copy the files.
4. In the **Instrument Files** area, click **Upload**. The **Transfer Files** dialog box appears.

5. Verify that the source file or folder and the destination folder are correct, and then click **OK**.
6. The **Copying Files** dialog box appears showing the status of the operation. When the status is 100%, click **Done**.

Copying files between the 882's flash memory and PC card

To copy files between media in a 882:

1. Access the 882's FTP browser by choosing the **FTP Browser** menu item from the main web page. The 882 FTP Browser appears. The Instrument Files area shows the files stored on the 882. The Host Files area shows the files stored on the PC.

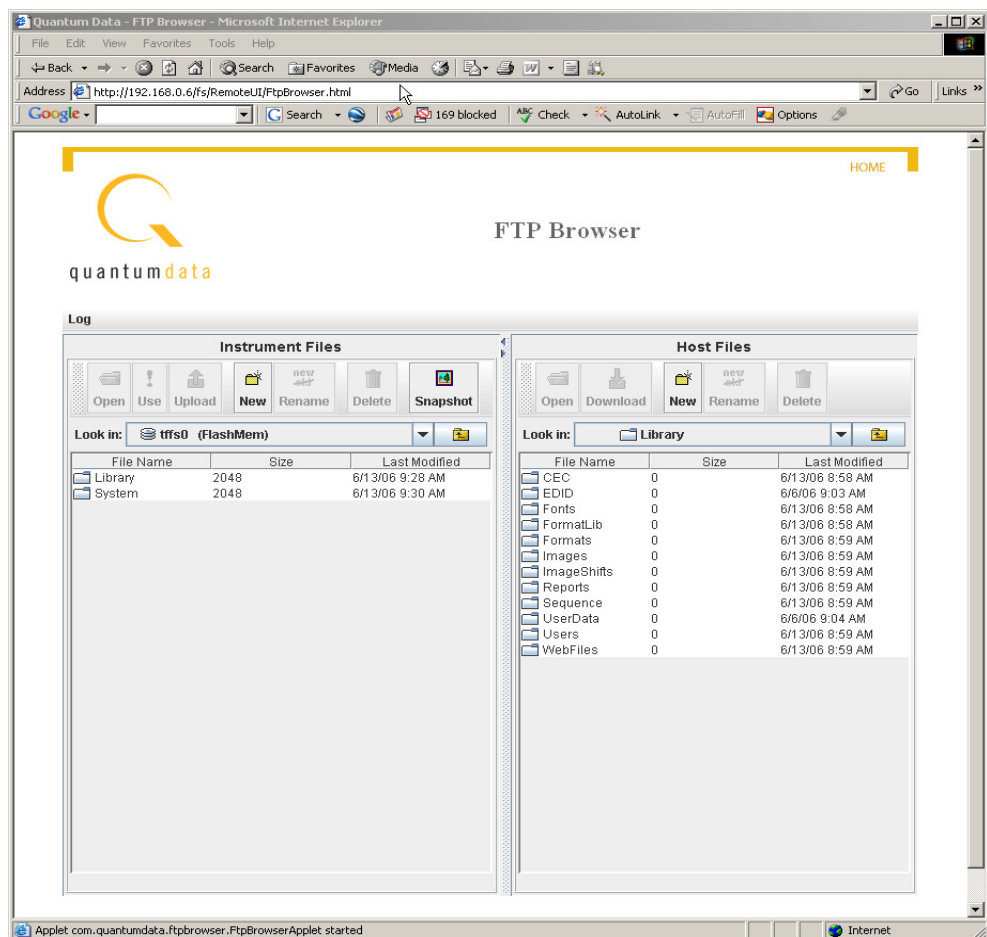

2. In the **Instrument Files** area, click the down arrow by the **Look in** box and select **tffs0**. This is the 882's flash memory.
3. Repeat step 2 to open a second 882 FTP Browser. In the **Instrument Files** area of the second 882 FTP Browser window, click the down arrow by the **Look in** box and select **card0**. This is the 882's PC card.

4. Locate the file or folder you want to copy in the source window.
5. Locate and open the destination folder in the destination window.
6. Drag the file or folder from the Instrument Files area of the source window to the Instrument Files area of the destination window.

Copying files between 882s

To copy files between 882s:

1. Open a Web browser (such as Internet Explorer) and type the source 882's IP address in the address entry field. The source 882's home page appears in the browser.

quantumdata

HOME

VIRTUAL VIDEO DISPLAY

Click Here

▶ Tools

- Format Editor
- Virtual Display
- FTP Browser
- CMD Terminal
- Auxiliary Channel Analyzer
- EDID Compare Tool
- SAM+
- EDID Editor
- CEC Controller
- Generated Reports

2. Access the 882's FTP browser by choosing the **FTP Browser** menu item from the main web page. The 882 FTP Browser appears. The Instrument Files area shows the files stored on the 882. The Host Files area shows the files stored on the PC.

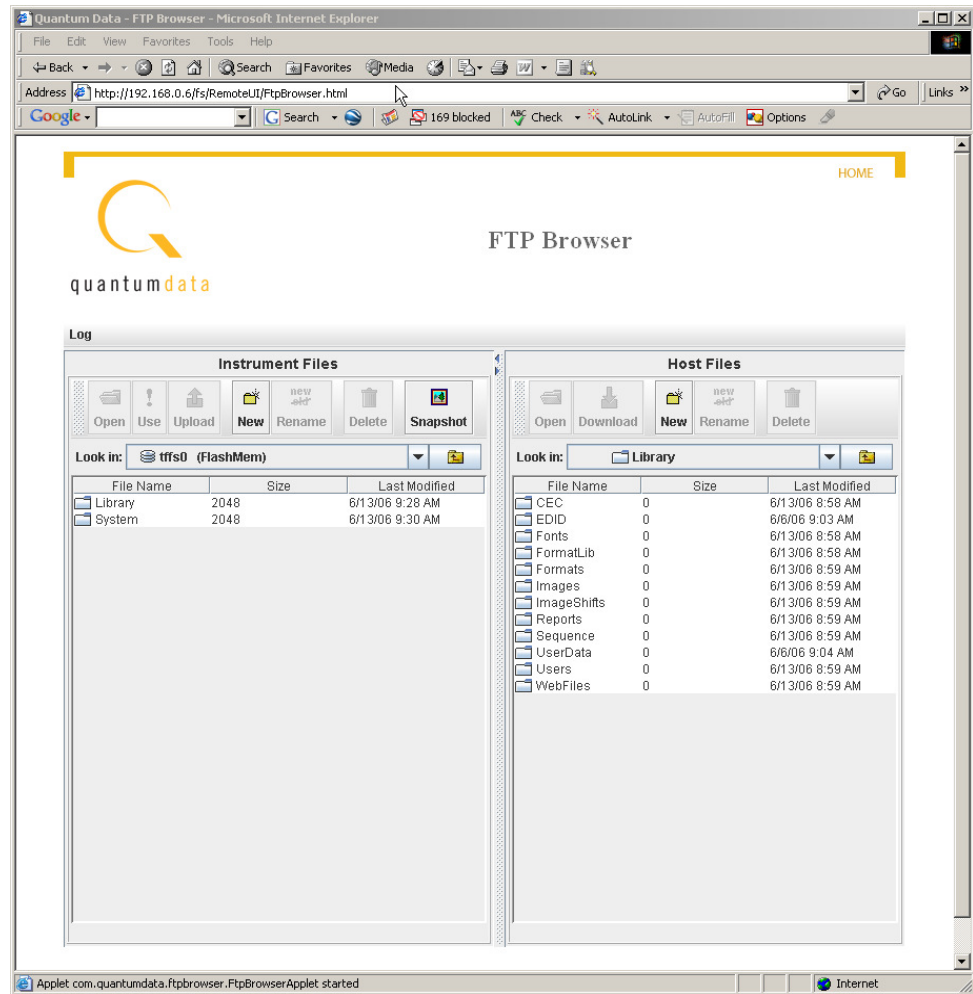

3. Repeat steps 1 and 2 for the target 882.

Note: You now have two instances of the 882 FTP Browser running: one for the source 882 and one for the target 882.

4. In the 882 FTP Browser window for the source 882, locate the file or folder you want to copy as follows:
 - a. In the **Look in** box, click the down arrow and select the medium where the file or folder is located. Select **tffs0** for the 882's flash memory or **card0** for the 882's PC card.
 - b. In the list of files, select the file or folder.

5. In the 882 FTP Browser window for the target 882, open the destination folder as follows:
 - a. In the **Look in** box, click the down arrow and select the medium to which you want to copy the file or folder. Select **tffs0** for the 882's flash memory or **card0** for the 882's PC card.
 - b. In the list of files, open the destination folder.
6. Drag the file or folder from the Instrument Files area to the Host Files area of the source window. A confirmation dialog box appears.
7. Click **OK** to copy the files.
8. Locate the file or folder in the Host Files area in the target window. Drag the file or folder from the Host Files area to the destination folder in the Instrument Files area of the target window. A confirmation dialog box appears.
9. Click **OK** to copy the files.

Command line interface

Common test procedures can be accomplished using the 882's physical controls on the front panel, Virtual Front Panel or through the command line interface. The 882 supports an ASCII command and query language that allows you to control the 882 interactively or through batch processing of command files. All 882 functions are supported through this interface. The command line interface is available through three physical interfaces:

- Serial (RS-232) interface (terminal session, such as HyperTerminal, via the serial port)
- Ethernet network interface (Telnet session or Web browser via the Ethernet port)
- GPIB (IEEE-488) interface (via the GPIB port)

The serial and Ethernet interfaces are described in this section. For information on the GPIB interface, see Chapter 5, "[Using GPIB Interface.](#)"

Working with the serial interface

This section describes how to connect the 882 to the PC via the serial port, how to establish a terminal session with the 882 using a terminal emulator such as HyperTerminal, and how to change serial port settings.

To connect the 882 to the PC:

To set up the 882 to use the serial interface, connect a serial null modem cable from the serial port of the PC to the SERIAL connector on the rear of the 882.

Establishing a terminal session with the 882

The following procedure describes how to establish a terminal session with the 882 through the serial port. For information about establishing a Telnet session over an Ethernet LAN, see "[Establishing a Telnet session with the 882](#)" on page 33.

To establish a terminal session with the 882:

1. Open a terminal emulator, such as HyperTerminal. Configure the terminal emulator to use the parameters set in the 882. By default, the 882's serial port is set to 9600 baud, 8 data bits, no parity, 1 stop bit, no flow control.
2. Establish a terminal connection with the 882. Press Enter until the C:> prompt appears.

Configuring the 882's serial port

The following procedures describe how to change the 882's default serial port configuration for a terminal session. You can configure the serial port through either the front panel, Virtual Front Panel or through the command line interface.

To configure the 882's serial port through the front panel or Virtual Front Panel:

1. Press the **Tools** key. The Tools menu appears on the 882's display as shown below.

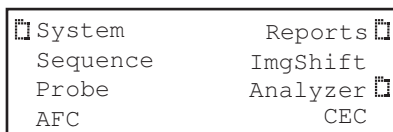

2. Choose the **System** item by pressing the adjacent soft key. The System menu appears on the 882's display as shown below.



3. Choose the **Serial** item by pressing the adjacent soft key. The serial port settings appear on the 882's display.

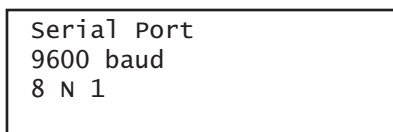

4. Press the **Settings** key. The following information appears on the 882's display:

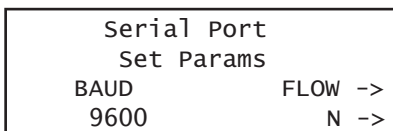

5. To change the baud rate, do the following:
 - a. Position the blinking cursor on the baud rate setting. To do this, press the soft key adjacent to the arrow by the baud rate setting to move the cursor left or right until it appears on the baud rate setting.
 - b. Press the + or - keys to adjust the baud rate setting up or down.
6. To change the flow control state, do the following:
 - a. Position the blinking cursor on the flow control setting. To do this, press the soft keys adjacent to the arrow by the flow control setting until the cursor appears on the current flow control setting (N, H, or T).
 - b. Press the + or - keys to change the setting.

7. To change the number of data bits, do the following:
 - a. Press the soft keys adjacent to the third row until **CHAR** appears. The current data bits setting is shown in the bottom row.

```

Serial Port
Set Params
<- CHAR  PRTY  STOP
      8    N    1 ->

```

- b. Position the blinking cursor on the CHAR setting. To do this, press the soft keys adjacent to the arrow by the CHAR setting until the cursor appears on the current data bits setting.
 - c. Press the + or - keys to adjust the setting up or down.
8. To change the parity, do the following:
 - a. Position the blinking cursor on the PRTY setting. To do this, press the soft keys adjacent to the arrow by the PRTY setting until the cursor appears on the current parity setting.
 - b. Press the + or - keys to adjust the setting up or down.
9. To change the stop bits, do the following:
 - a. Position the blinking cursor on the STOP setting. To do this, press the soft keys adjacent to the arrow by the STOP setting until the cursor appears on the current stop bits setting.
 - b. Press the + or - keys to adjust the setting up or down.
10. To save the changes, press the **Enter (Options)** key. The following choices appear on the 882's display:

```

Apply Settings?
                                     Back
Yes                                     No

```

To save the changes, choose the **Yes** item by pressing the adjacent soft key.

To exit without saving the changes, choose the **No** item.

To return to the previous screen without saving the changes, choose the **Back** item.

To configure the 882's serial port through the command line interface:

1. Establish a session with the 882 using HyperTerminal over a serial connection or Telnet over an Ethernet LAN. For instructions, see ["Establishing a terminal session with the 882"](#) on page 30 and ["Establishing a Telnet session with the 882"](#) on page 33.
2. At the session prompt, enter the following command to query the 882 for the current serial port settings:

MODE?

The 882 returns the current values:

```
9600,N,8,1,N,N
```

3. To change the settings, enter the following command:

```
MODE baud parity data stop handshake protocol
```

For example, to change the baud rate to 38400, enter the following command:

```
MODE 38400 n 8 1 n n
```

Note: *In this example, after you press Enter, the baud rate of the session and baud rate of the 882 will no longer match. This will cause the session to lose its connection with the 882. Close the session, change the session baud rate to 38400, and then re-open the session.*

Working with the network interface

This section describes how to connect the 882 to a PC via an Ethernet LAN and how to establish a Telnet session with the 882.

To connect the 882 to a PC over an Ethernet LAN:

1. Connect the Ethernet cable between the PC's Ethernet port and an active Ethernet jack.
2. Connect an Ethernet cable between the 882's ETHERNET port and an active Ethernet jack.

Establishing a Telnet session with the 882

The following procedure describes how to establish a Telnet session with the 882 over an Ethernet LAN. For information about establishing a terminal session over a serial connection, see "[Establishing a terminal session with the 882](#)" on page 30.

To establish a Telnet session with the 882:

1. Using a text terminal application, such as DOS Command Prompt, enter the following command:

```
telnet 882IPaddress
```

Example:

```
telnet 192.168.254.220
```

2. The `/tffs0>` prompt appears. Type commands at the `/tffs0>` prompt, and press Enter after each command.

Sending commands interactively

This section describes how to send commands through an interactive command line interface session. The 882 parses command lines one at a time. Command lines must be terminated with a carriage return (<cr>). The 882 immediately echoes each character as it is received and places it in a command line buffer. Commands are not case sensitive.

When sending multiple commands at once, separate each command with a semi-colon. For example, to load the 480p59 format with the SMPTEbar image, send the following commands:

```
FMTL 480p59
IMGL SMPTEbar
ALLU
```

Common commands

- To apply an image and format to the 882 hardware, enter:

```
ALLU
```

- To display the name of the format currently in the format buffer, enter:

```
FMTL?
```

- To load a format, enter:

```
FMTL format_name
```

- To apply the format to the 882 hardware, enter:

```
FMTU
```

- To load an image, enter:

```
IMGL image_name
```

- To apply the image to the 882 hardware, enter:

```
IMGU
```

Sending command files (serial interface only)

When developing more complex, custom test sequences or formats, it is easiest to enter commands in a text file, and then send the file to the 882. This approach allows you to modify the file without entering the entire command script.

Note: *Sending command text files can be performed via the serial interface only.*

To send a text file to the 882:

1. Using a text editor, enter commands into a text file, and save the text file using a *.txt extension.

2. Establish a session with the 882 using a terminal emulator, such as HyperTerminal over a serial connection.
3. At the C:> prompt, transfer the text file to the 882. For example, to transfer a file using HyperTerminal, do the following:
 - a. On the **Transfer** menu, click **Send Text File**. The **Send Text File** dialog box appears.
 - b. Select the text file you want to send, and then click **Open**. HyperTerminal displays the commands as they are sent.
 - c. Press **Enter** once to ensure that the last command is sent.

Working with user profiles

The 882 provides user profiles that enable you to quickly load pre-defined configurations. This can be done either through the front panel, virtual front panel or the command line. For example, you can create different profiles for each operator, production line, display type under test, and so on.

A user profile is always active on the 882 (“User1” is the default profile). While active, the 882 tracks subsequent format and format options, format catalogs, interface, and content selections made by the user. These configuration settings are saved to the active profile when a different user profile is chosen on the 882.

To choose a user profile:

1. Press the **Source** and **Content** keys simultaneously (or press USER on the Virtual Front Panel) to access the list of user profiles.

The following is an example of a set of user profiles that might appear on the 882’s display. Note that User1 is active, which is indicated by the = sign.

=User1	User2
User3	User4
User5	User6
User7	User8

2. Choose another user by pressing the adjacent soft key. For example, to change to User5, press the soft key adjacent to User5. This will save the configuration settings for User1 and select the profile for User5. Any subsequent configuration changes will apply to User5.

Alternatively, to switch users using the command line interface, enter the following command:

```
USRU username.xml
```

For example, to select User5, enter

```
USRU User5.xml
```

To query the current user, enter

```
USRU?
```

The 882 returns the current user name.

```
/tffs0/Library/Users/User5.xml
```

To create a new user profile:

The procedure for setting up a new user profile is accomplished using the command line interface.

1. Establish a session with the 882 using either HyperTerminal over a serial connection or Telnet over an Ethernet LAN. See “[Establishing a terminal session with the 882](#)” on page 30 or “[Establishing a Telnet session with the 882](#)” on page 33.
2. Enter the following command:

```
USRA username.xml
```

```
USRU username.xml
```

Note: A user name is 8 alphanumeric characters.

For example, to set up a user profile called “User3,” enter:

```
USRA User3.xml
```

```
USRU User3.xml
```

A new user profile is created with default configuration settings and becomes the active profile on the 882. While active, the 882 tracks subsequent format and format options, format catalogs, interface, and content selections made by the user. These configuration settings are saved to the active profile when a different user profile is chosen on the 882.

To delete a user profile:

1. Enter the following command:

```
USRK username.xml
```

For example to delete User5, enter:

```
USRK User5.xml
```

2 Testing Video Displays

Topics in this chapter:

- [General video display testing procedures](#)
- [Testing analog computer \(IT\) CRTs](#)
- [Testing digital computer \(IT\) FPDs](#)
- [Testing analog composite video SDTV \(CE\) CRTs](#)
- [Testing analog component video SDTV \(CE\) CRTs](#)
- [Testing digital component video HDTV \(CE\) FPDs](#)
- [Using the Image Caching feature](#)
- [Using the AuxTest image](#)
- [Using the ImageShift utility](#)
- [Adjust Frequency Function](#)
- [Keypad Utility](#)

General video display testing procedures

This section provides an overview of basic steps performed to test your video display using your 882 or 881. Testing your video display involves four basic steps:

1. Connecting 882 to display under test.
2. Selecting interface type for display under test.
3. Selecting a video format appropriate for display under test.
4. Selecting an image suitable for testing the display under test.

Making physical connection

The first step is to make a physical cable connection between the 882 and display under test. The following table provides guidelines for connecting the 882C, 882E, 881C or 882E generator to the display under test.

Display type		Signal type	Port (Interface)	Cable
Information Technology (IT)	Computer - VESA (DMT, CVT)	Analog component RGB	VGA	VGA to VGA
	Computer - VESA DDWG	Digital component RGB	HDMI OUT (HDMI-D)	HDMI to DVI
	DisplayPort (882E only)	Digital component RGB	DisplayPort OUT	DisplayPort
Consumer Equipment (CE)	SDTV - ITU-470-6 baseband	Analog composite CVBS	CVBS	BNC to RCA 75 Ohm
	SDTV - ITU-470-6 baseband	Analog composite S-Video	SVIDEO	S-Video (miniDin)
	SDTV - CEA-861B	Analog component YPbPr	VGA	VGA to RCA ¹
	HDTV - CEA-861C	Digital component DVI RGB	HDMI OUT (HDMI-D)	HDMI to DVI
	HDTV - CEA-861C	Digital component HDMI RGB and YCbCr	HDMI OUT (HDMI-H)	HDMI to HDMI
Professional AV	SDI (SMPTE-259M) and HD-SDI (SMPTE-292M-C)	Digital component YCbCr	SDI/HD-SDI	BNC Coax

1. Optional cable available from Quantum Data.

Use the following table to connect the 882D or 881D generator to the display under test.

Display type		Signal type	Port (Interface)	Cable
Information Technology (IT)	Computer - VESA (DMT, CVT)	Analog component RGB	DVI-A with DVI to VGA adapter	VGA to VGA
	Computer - VESA DDWG	Digital component RGB	DVI for single and dual link or HDMI OUT (HDMI-D) for single link only	DVI to DVI cable for DVI connector or HDMI to DVI for HDMI-D connector
Consumer Equipment (CE)	SDTV - ITU-470-6 baseband	Analog composite CVBS	CVBS	BNC to RCA 75 Ohm
	SDTV - ITU-470-6 baseband	Analog composite S-Video	SVIDEO	S-Video (miniDin)
	SDTV - CEA-861B	Analog component YPbPr	DVI with DVI to VGA adapter	VGA to RCA ¹
	HDTV - CEA-861C	DVI for single and dual link or HDMI OUT (HDMI-D) for single link only	HDMI OUT (HDMI-D)	DVI to DVI cable for DVI connector or HDMI to DVI for HDMI-D connector
	HDTV - CEA-861C	Digital component HDMI RGB and YCbCr	HDMI OUT (HDMI-H)	HDMI to HDMI
Professional AV	SDI (SMPTE-259M) and HD-SDI (SMPTE-292M-C)	Digital component YCbCr	SDI/HD-SDI	BNC Coax

1. Optional cable available from Quantum Data.

Selecting interface type

After making the physical connection, you are ready to select the interface type for your display under test.

You can select the interface using either the front panel keys or the command line interface. The interface is one of the following:

- DVI-A - For testing analog VESA displays on the 882D.
- CVBS - For testing composite analog consumer electronic displays.
- S-Video - For testing composite (separate luma and chroma) consumer electronic displays.
- DVI-D - For testing digital VESA displays (dual link) on the 882D.
- HDMI-D - For testing DVI displays through an HDMI interface.

- HDMI-H - For testing HDMI consumer electronic displays.
- SDI/HD-SDI - For testing SDI and HD-SDI professional AV displays.

To select an interface:

1. Press the **Interface** key to access the list of interfaces. A listing of signal interfaces appears on the 882's display as shown below.

```
* VGA          CVBS
HDMI-D        S-VIDEO
HDMI-H        SDI
```

2. Choose the interface by pressing the adjacent soft key. The interface is activated and the port outputs the currently selected image and format. An asterisk is shown beside the selected interface.

Alternatively, to select the interface through the command line interface, enter commands like shown below:

```
XVSI 9          // Selects the VGA interface
ALLU           // Applies the interface setting to the 882
```

To define the display size:

Once you have selected the interface, you can change the parameters specifying the physical size of the display (if your application calls for that).

1. After selecting the interface, press the **Sink** key and then the **Settings** key. The following information appears on the 882's display.

```
      Display
      Physical Size
      HSIZ          ->
<- 300.00
```

2. Navigate to the other parameters for physical size (VSIZ and USIZ) to set the display size for your test application.

To gate off the output:

You can gate off and on the interface output as follows:

1. Press the **Interface** key, then press the **Options** key. The following information appears on the 882's display.

```
+Output          Mark #1-
                  Disable 2-
```

2. Enable or disable the interface output by pressing the adjacent soft key.

Selecting video format

Once you have selected the interface type for the display under test, you need to select a video output format. A format defines a set of video, timing, and sync parameters for a specific device or standard. This section explains how to configure the 882 to output video formats that are supported by the display under test.

Important: *If the display under test has not implemented hot plug correctly, you will have to bypass hot plug detection in the 882 to enable video output. See below for procedure on bypassing hot plug detection.*

Note: *For more information about formats, see Chapter 6, “[Working with Formats](#).”*

Setting Source list of formats

The 882 provides a Source list of standard (pre-defined) formats. The Source list can be set automatically when connecting to a EDID-compatible display. Otherwise, you can manually set which formats are listed.

To automatically set Source list of formats for EDID-compatible display:

When testing EDID-compatible displays, the 882 can automatically update the Source list to include only formats supported by the display under test. To do this:

1. Connect the 882 to the display you want to test.
2. Press the **Sink** key. The following information appears on the 882's display.

```
Manufacturer:SNY
Product Code:144
Serial#:7011007
Week:20 Year:1998
```

Note: *If there are two displays connected you will have to press the Sink key a second time to access the display connected to the second HDMI output.*

3. Press the **Options** key. The following information appears on the 882's display.

```
-EDID Formats      CDF ⌘
+HP Bypass
-Emulate
```

4. Choose the **EDID Formats** item by pressing the adjacent soft key. A + appears next to EDID Formats indicating enabled.

The 882 loads the Source list with formats supported by the connected display (hot-plug formats read via EDID structure of attached display).

5. To redisplay all formats, press the soft key adjacent to EDID Formats. A '-' (minus sign) next to EDID Formats indicates it is disabled.

To bypass hot plug detection:

If the display under test has not implemented hot plug correctly, you will have to bypass hot plug detection in the 882 to enable video output.

1. Connect the 882 to the display you want to test.
2. Press the **Sink** key. The following information appears on the 882's display.

```
Manufacturer:SNY
Product Code:144
Serial#:7011007
Week:20 Year:1998
```

3. Press the **Options** key. The following information appears on the 882's display.

```
-EDID Formats          CDF ↵
+HP Bypass
-Emulate
```

4. Choose the **HP Bypass** (hot plug bypass) item by pressing the adjacent soft key. A + appears next to HP Bypass indicating enabled.

To manually set Source list of formats for non-EDID-compatible display:

When testing a display that is not EDID-compliant, the Source list is filtered to display only those formats suitable for a particular interface type. For example, if you select CVBS, the Source list does not include the VESA formats.

The 882's format library is comprised of a set of format catalogs. You can set up the 882 to show only the formats you want, in the order you want, when you browse through the Source list. See "[Format catalogs](#)" on page 223 for details.

To use Emulate mode:

Emulate mode automatically sets color space, synchronization type, and other settings based on the interface and format selected:

- For VGA interface, synchronization type and color space are automatically set and are not changeable.
- For HDMI interface, synchronization type and color space are automatically set, but color space can be changed.

1. Connect the 882 to the display you want to test.
2. Press the **Sink** key. The following information appears on the 882's display.

```
Manufacturer:SNY
Product Code:144
Serial#:7011007
Week:20 Year:1998
```

3. Press the **Options** key. The following information appears on the 882's display.

-EDID Formats	CDF ↵
+HP Bypass	
-Emulate	

4. Choose the **Emulate** item by pressing the adjacent soft key. A + appears next to Emulate indicating enabled.

Alternatively, to select the emulate mode through the command line interface, enter the command shown below:

```
EMUG 1 // Enables emulate mode
```

To disable the emulate mode through the command line interface, enter the command shown below:

```
EMUG 0 // Disables emulate mode
```

Selecting a format

From the Source list of formats, you select the video format output for your display under test.

To select a format:

1. Identify the type of display (composite television, component standard definition television, component high definition television, computer equipment, or other specialty display).

Note: The 882 has a library of standard formats. For a description of how the library is organized, see "[Understanding the format library](#)" on page 46.

2. For non-EDID compliant displays, check the specifications of your display for supported formats.

3. Press the **Source** key to access the list of formats. A list of formats appears on the 882's display as shown below. To see all of the formats, press the + and - keys.

*DMT0660	DMT0672
DMT0675	DMT0685
DMT0785H	DMT0856
DMT0860	DMT0872

Note: The list of formats displays when pressing the **Source** key may be a filtered or abbreviated list. Formats not suitable for the selected interface type will not appear by default on the **Source** list. Also, you can disable format catalogs to prevent certain formats from appearing on the Source list. For more information about format catalogs, see "[Format catalogs](#)" on page 223.

4. Choose a format by pressing the adjacent soft key.

Upon selecting a format, you can modify the format options and settings if necessary. For instructions on this, see [“Configuring format parameters”](#) on page 177.

Understanding the format library

The 882 has several built-in formats to test a broad range of display types. These formats are grouped in the following categories:

- Composite television formats
- Component standard definition television formats
- Component high definition television formats
- Computer display formats
- Military and medical display formats
- Miscellaneous formats

Note: A summary of the format naming conventions is provided in this section. For a detailed description of the naming conventions, see [“Format library”](#) on page 171.

Composite television formats

Composite television formats are named by the standards defining them. The first three to five characters of the format name indicate the color coding scheme. The first set of characters refers to the standard. The next characters are optional and indicate adjustments to the format. Examples of these formats are:

- NTSC (North American TV)
- PAL (European TV)
- NTSC-J (where J refers to a Japan standard per NTSC without 7.5 IRE setup)
- PAL-N (where N indicates 3.58205625 MHz color sub-carrier)
- PAL# (where # indicates that the sampling rate is reduced to achieve square pixels)

Component standard definition television formats

Component SDTV formats are applicable in the case of RGB and YPbPr. These formats are named by their vertical resolution, scanning method, and frame rate. The initial characters indicating the resolution are followed by the scanning method. The two characters following the scanning method indicate the frame rate. A typical example of a component standard definition TV video format is:

- 480i2x30 (for a vertical resolution of 480 pixels with interlaced scanning and a 30 Hz frame refresh rate; 2x indicates that the pixels are double-clocked for DVI compatibility).

Component high definition television formats

Component high definition television formats, like the standard definition television formats, are named by their vertical resolution, scanning method, and frame rate. These formats are applicable in the case of RGB, YPbPr, and YCbCr. These initial characters indicating the resolution are followed by the scanning method. The two characters following the scanning method indicate the frame rate. A typical example of a component high definition TV video format is:

- 1080i30 (for a vertical resolution of 1080 active vertical lines with interlaced scanning and a 30 Hz frame refresh rate).

Computer display formats

Computer display formats are assumed to use progressive scanning. Computer display format names consist of four blocks. The initial three characters indicate the vendor ID using the EISA ID (for example, IBM, SUN, and VSC) or the standard body or acronym (for example, SMT, DMT, GTF, CEA, and EIA). The next two characters provide the first two digits of the horizontal resolution in pixels. Following the horizontal resolution are two characters which indicate the frame rate. The final character indicates the aperture, which is used only if the aperture is not 1.33 (A). The following are examples of computer display formats:

- VSC1275 for Viewsonic 1280 by 1024 at 75 Hz
- DMT0685 for Discrete Monitor Timing with 680 by 480 at 85 Hz

Viewing or modifying format parameters

You can use the Format image to view detailed information about formats in the 882.

You can also modify format parameters through the front panel, through the command line interface, or through the Format Editor. These procedures are provided in “[Configuring format parameters](#)” on page 177.

Selecting image

Once you have determined the format or formats appropriate for testing the display, you will apply a series of images suitable for evaluating the display. Of primary importance is determining what type of display you are testing (for example, CRT or digital flat panel display). You must also determine if you are testing composite TV and use images appropriate for these formats and video types.

Each image in the 882's library is intended to test one or more attributes of a particular display type and video type.

Rendering images

Use the following procedures to view primary images.

Once you have selected an image you can modify the image options if necessary. For instructions on this refer to [“Viewing and modifying image options”](#) on page 231.

To select an image:

1. Identify the type of display (CRT or FPD) and the images that are used for testing this type of display (see the table below).
2. Press the **Content** key. A list of images appears on the 882’s display as shown below. Press the + and - keys to see all of the images.

Acer1	Acer2
Acer3	Acer4
Acer5	Acer6
Acer7	Acer8

Note: *The list of images that appears when you press the **Content** key may be a filtered or abbreviated list. You may have disabled certain image catalogs, preventing the images in those catalogs from appearing on the Content list. For more information about image catalogs, see [“Creating image catalogs”](#) on page 241.*

3. Choose an image by pressing the adjacent soft key.

The table below provides a summary of display characteristics and the images used to evaluate them. For details on the images and display attributes, see Appendix B, “[Image Reference](#).”

Display type	Display test	Recommended images
Analog CRT	Geometry (pin and barrel, linearity)	Static images Hatch (TVHatch, Hatch_16 , Hatch_20), CirclesL , Geom_1 - Geom_5 , SMPTE133
	Focus	Focus_@6 , Focus_@7 , Focus_@8 , Focus_@9 , Text_9 , Text_9T , Text_11 , Text_12T , Text_16
	Photometry (chrominance, contrast, levels)	Flat , Flat07 , Flat13 , Flat20 , Flat27 , Flat33 , Flat40 , Flat47 , Flat53 , Flat60 , Flat67 , Flat73 , Flat80 , Flat87 , Flat93 , FlatGray , Flat_01 , Flat_02 , Flat_03 , Flat_04 , Flat_05 , Flat_06 , Flat_07 , Flat_08 , Flat_09 , Flat_10 , Flat_11 , Flat_12 , Flat_13 , Flat_14 , Flat_15 , Flat_16 , Ramp_B , Ramp_G , and Ramp_R , ColorBar , SMPTEbar , TVBar100 & TVBar_75 (TV formats only)
	Luminance	SMPTE133 (grayscale), Grays5 , Grays9 , Grays11 , Grays16 , Grays32 , Grays64
	Gamma correction	SMPTE133 (checkbox)
	Resolution	BurstTCE , Burst (TV formats only), Grill_11 , Grill_15 , Grill_22 , Grill_33 , Grill_44
	Pulse (CE SDTV)	PulseBar
	Centering	Outline0 , Outline1 , Outline2 , Outline3
	Voltage Regulation	Regulate
	Electromagnetic Interference	EMITest1 , EMITest2 , EMITest3 , EMITest4 , EMITest5

Display type	Display test	Recommended images
Digital flat panel (fixed pixel display)	Pixel anomalies (stuck pixels, misc sampling)	Flat, Raster, Ramp_B, Ramp_G, and Ramp_R, Focus_@6, Focus_@7, Focus_@8, Focus_@9, Text_9, Text_9T, Text_11, Text_12T, Text_16
	Photometry (chrominance, contrast, levels)	Flat, Flat07, Flat13, Flat20, Flat27, Flat33, Flat40, Flat47, Flat53, Flat60, Flat67, Flat73, Flat80, Flat87, Flat93, FlatGray, Flat_01, Flat_02, Flat_03, Flat_04, Flat_05, Flat_06, Flat_07, Flat_08, Flat_09, Flat_10, Flat_11, Flat_12, Flat_13, Flat_14, Flat_15, Flat_16, Ramp_B, Ramp_G, and Ramp_R, ColorBar, SMPTEbar, SMPTE133
	Luminance	SMPTE133 (Grayscale), Grays5, Grays9, Grays11, Grays16, Grays32, Grays64
	Centering	Outline0, Outline1, Outline2, Outline3
	Resolution	BurstTCE, Grill_11, Grill_15, Grill_22, Grill_33, Grill_44
	Persistence	Animated images: Persist, Cubes, SlideBox
	3D (HDMI only)	3DCRTK, 3DCUBES, custom bitmap images

Rendering image versions

Many images have secondary or alternate versions and some images have many versions. Use the procedures below to view the alternate and multiple image versions.

To view alternate image versions in the Content list:

1. Select an image by pressing the **Contents** key and selecting an image with the adjacent soft key until a * appears next to image name.
2. Enable and view image versions as follows:
 - a. Press the **Options** key. The following menu will appear on the 882's display for images with a single secondary image:

-Alternate	Red+
-NoGamma	Green+
-Noise	Blue+

- b. Choose the **Alternate** item by pressing the adjacent soft key until a + appears next to the item.

+Alternate	Red+
-NoGamma	Green+
-Noise	Blue+

3. Toggle back and forth between the images using the adjacent soft key.

To view multiple image versions in the Content list:

1. Select an image by pressing the **Contents** key and selecting an image with the adjacent soft key until a * appears next to image name.
2. Enable and view image versions as follows:
 - a. Press the **Options** key. The following menu appears on the 882's display:

```
-More
                        Red+
-NoGamma                Green+
-Noise                  Blue+
```

- b. Choose the **More** item by pressing the adjacent soft key until a + appears next to **More** and **Rendition** appears on the other side of the menu.

```
+More  Rendition: 000
                        Red+
-NoGamma                Green+
-Noise                  Blue+
```

- c. Press the + and - keys to advance through the image versions. Each version shows the format parameters for a different format in the Source list.

Alternatively, to enable and view image versions using the command line interface, enter the following commands:

```
ISUB 1 // Enables sub images
IVER 1 // Specifies the first image version
IMGU // Activates the image version
IVER 2 // Specifies the second image version
IMGU // Activates the image version
```

3. When you are finished, disable image versions by pressing the **Options** key and choosing **More** until a - appears next to it.

Alternatively, to disable image versions using the command line interface, enter the following command:

```
ISUB 0 // Disables sub images
```

Testing analog computer (IT) CRTs

This section describes how to test analog computer (IT) displays. The display responses shown as examples in the procedures use the 882C. However you can also test analog composite with the 882D using the same format and image selections. The interface selection is different and is noted.

To set up the 882 to test an analog computer CRT:

1. Connect a standard VGA cable between the VGA connector on the 882 and the VGA connector on the display under test.
2. Calibrate the 882 in accordance with the procedures described in “[Calibrating signal level](#)” on page 87.
3. Determine the formats to test (see “[Setting Source list of formats](#)” on page 43).
4. Determine additional formats to test based on the resolution of the display. The VESA formats are shown below:

Standard	Quantum Data format name
VGA	DMT06xx
SVGA	DMT08xx
XGA	DMT10xx
SXGA	DMT12xx
UXGA	DMT16xx
QXGA	DMT20xx
QSXBA	DMT25xx

5. Determine the images to test. For analog CRTs, you typically want to select images to test for geometry, focusing, photometry, resolution, cross talk, EMI, and regulation characteristics. For more details on what images test these specific display attributes, see “[Selecting image](#)” on page 47 or Appendix B, “[Image Reference](#).”

To activate the VGA interface on the output port:

1. Press the **Interface** key to access the list of interfaces. A listing of signal interfaces appears on the 882’s display as shown below.

* VGA	CVBS
HDMI-D	S-VIDEO
HDMI-H	SDI

2. Choose the **VGA** item by pressing the adjacent soft key. The interface is activated and the port outputs the currently selected image and format. An asterisk is shown beside the selected interface.

Alternatively, to select the interface through the command line interface, enter the following commands:

```
XVSI 9          // Selects the VGA interface
ALLU           // Applies the interface setting to the 882
```

If you are using the 882D you select the DVI-A interface.

To verify the test set-up:

1. Press the **Source** key to access the list of formats.
2. Choose a standard format (for example, DMT0660) by pressing the adjacent soft key.

Alternatively, you can load the format with the following command:

```
FMTL DMT0660
FMTU
```

3. Press the **Content** key to access the list of images.
4. Choose a suitable image (for example, ColorBar) by pressing the adjacent soft key.

Alternatively, you can load the image with the following command:

```
IMGL ColorBar
IMGU
```

5. Verify that the image appears on the display under test.

To test the display:

1. Press the **Source** key and select the first test format.

Alternatively, you can load the format with the following command:

```
FMTL format_name
FMTU
```

2. Press the **Content** key and select the first test image.

Alternatively, you can load the image with the following command:

```
IMGL image_name
IMGU
```

3. Repeat steps 1 and 2 for all formats and test images. Use the following guidelines to verify proper operation:
 - When testing geometry with the Hatch images (for example, [Hatch20](#)) look for distortion with concave or convex lines near the periphery of the display. Look for irregular spacing on the cross hatch patterns.
 - When testing photometry such as chrominance, use the [ColorBar](#), [SMPTE133](#), or [SMPTEbar](#) images. Look for missing bars which may indicate a dead or

unconnected channel. Also, look at the transitions between the bars; they should be sharp and distinct. Each bar also should be uniform in color and intensity across its entire width.

- To test luminance, you can use the [SMPTE133](#) (grayscale portion) image. To test gamma correction, you can use the [SMPTE133](#) (checkbox portion) image. The detailed methods for verifying these parameters on the [SMPTE133](#) image are provided in Appendix B, “[Image Reference](#).”
- When testing focus with the Focus or Text images, the characters in all areas of the display should be well-formed and in focus.
- When testing resolution with the Grill images, you should be able to see individual and distinct stripes in all areas of the display at all four resolutions.
- When testing for centering use the Outline images. For detailed methods for verifying centering with the Outline images, see Appendix B, “[Image Reference](#).”
- When testing for high voltage regulation with the [Regulate](#) image, observe the outline at the edges of the image. It should stay in place and not pull away from the area of the large white blinking patch (when it appears).

Note: *You can customize your 882 to run through a specified set of formats and images automatically or manually by creating test sequences. See Chapter 8, “[Working with Test Sequences](#).” for details.*

Testing digital computer (IT) FPDs

This section describes how to test digital computer (IT) displays. You can test DVI on digital computer displays using the 882C up to single link through the HDMI connector. However you can test DVI digital computer displays up to full dual link on the 882D through the dual link DVI connector. The procedures below describe how to test HDMI, DVI or DisplayPort computer digital displays using the 882.

HDMI interface testing

To set up the 882 to test a digital FPD:

1. Connect a single or dual link DVI cable between the DVI connector on the 882 and the DVI connector on the display under test.
2. Determine the formats to test. See [“Setting Source list of formats”](#) on page 43 for instructions.
3. Determine the images to test. For digital flat panel displays, you typically want to select images to test for pixel anomalies, persistence, photometry, and resolution-related problems. For more information, see [“Selecting image”](#) on page 47 or Appendix B, [“Image Reference.”](#)

To activate the HDMI-D interface on the output port:

1. Press the **Interface** key. A listing of signal interfaces appears on the 882’s display as shown below.

DVI-A	CVBS
* DVI-D	S-VIDEO
HDMI-D	SDI
HDMI-H	

2. Choose the **DVI-D** item by pressing the adjacent soft key. The interface is activated and the port outputs the currently selected image and format that is compatible with the interface. An asterisk is shown beside the selected interface.

Alternatively, to activate the interface through the command line interface, enter the following commands:

```
XVSI 2          // Selects the HDMI-D interface
ALLU           // Applies the interface setting to the 882
```

To verify the test set-up:

1. Press the **Source** key to access the list of formats.
2. Choose a standard format (for example, DMT0660) by pressing the adjacent soft key.

Alternatively, you can load the format with the following command:

```
FMTL DMT0660
FMTU
```

3. Press the **Content** key to access the list of images.
4. Choose a suitable image (for example, SMPTE133) by pressing the adjacent soft key.

Alternatively, you can load the image with the following command:

```
IMGL SMPTE133
IMGU
```

5. Verify that the image appears on the display under test.

To test the display:

1. Press the **Source** key and select the first test format.

Alternatively, you can load the format with the following command:

```
FMTL format_name
FMTU
```

2. Press the **Content** key and select the first test image.

Alternatively, you can load the image with the following command:

```
IMGL image_name
IMGU
```

3. Repeat steps 1 and 2 for all formats and test images. Use the following guidelines to verify proper operation:

- When testing photometry such as chrominance, use the [ColorBar](#), [SMPTE133](#), or [SMPTEbar](#) images. Look for missing bars which may indicate a dead or unconnected channel. Also, look at the transitions between the bars; they should be sharp and distinct. Each bar also should be uniform in color and intensity across its entire width.
- To test luminance, you can use the [SMPTE133](#) (grayscale portion) image. To test gamma correction, you can use the [SMPTE133](#) (checkbox portion) image. The detailed methods for verifying these parameters on the [SMPTE133](#) image are provided in Appendix B, “[Image Reference](#).”
- When testing for centering use the Outline images. The detailed methods for verifying centering with the Outline images ([Outline0](#), [Outline1](#), [Outline2](#), [Outline3](#)) are provided in Appendix B, “[Image Reference](#).”
- When testing resolution with the Grill images, you should be able to see individual and distinct stripes in all areas of the display at all four resolutions.
- When testing for pixel anomalies use the Flat, Raster, and Ramp images. Use the Raster and Flat images to look for pixels that may be stuck on or off, respectively. The luminance should increase uniformly for the Ramp image. Also, look for sparkles indicating problems with sampling.

- When testing for persistence with the animated images (for example, [Cubes](#) and [Persist](#)), look for bleeding or trails in the wake of the moving object.

Note: *You can customize your 882 to run through a specified set of formats and images automatically or manually by creating test sequences. See Chapter 8, “[Working with Test Sequences](#).” for details.*

Testing analog composite video SDTV (CE) CRTs

This section describes how to test CRT composite televisions with analog composite video inputs. The display responses shown as examples in the procedures use the 882C. However you can also test analog composite with the 882D or 882E using the same interface, format and image selections.

To set up the 882 to test analog composite video SDTV:

1. Connect a standard coax cable between the CVBS connector on the 882 and the display under test.

Or, connect an S-video cable between the S-VIDEO connector on the 882 and the S-Video input on the display under test.
2. Determine which composite television standard you need, such as NTSC or PAL, and then select the formats compatible with the standard. Typically, you would test all the formats in the family of formats for a standard.
3. Determine the images to test. For analog CRTs you typically want to select images to test for geometry, focusing, photometry, resolution, cross talk, EMI, and regulation characteristics. For more details on what images test these specific display attributes, see “[Selecting image](#)” on page 47 or Appendix B, “[Image Reference](#).”

To activate the CVBS or S-Video interface on the output port:

1. Press the **Interface** key. A listing of signal interfaces appears on the 882’s display as shown below.

* VGA	CVBS
HDMI-D	S-VIDEO
HDMI-H	SDI

2. Choose either the **CVBS** or **S-VIDEO** item by pressing the adjacent soft key. The interface is activated and the port outputs the currently selected image and format. An asterisk is shown beside the selected interface **CVBS** or **S-VIDEO**.

Alternatively, to activate the interface through the command line interface, enter the following commands:

```
XVSI 6          // Selects the CVBS interface
or
XVSI 5          // Selects the S-VIDEO interface
ALLU           // Applies the interface setting to the 882
```

To verify the test set-up:

1. Press the **Source** key to access the list of formats.

2. Choose a typical composite format (for example, NTSC) by pressing the adjacent soft key.

Alternatively, you can load the format with the following command:

```
FMTL NTSC  
FMTU
```

3. Press the **Content** key to access the list of images.
4. Choose a suitable image (for example, SmpTeBar) by pressing the adjacent soft key.

Alternatively, you can load the image with the following command:

```
IMGL SmpTeBar  
IMGU
```

5. Verify that the image appears on the display under test.

To test the display:

1. Press the **Source** key and select the first test format.

Alternatively, you can load the format with the following command:

```
FMTL format_name  
FMTU
```

2. Press the **Content** key and select the first test image.

Alternatively, you can load the image with the following command:

```
IMGL image_name  
IMGU
```

3. Repeat steps 1 and 2 for all formats and test images. Use the following guidelines to verify proper operation:
 - When testing geometry with the Hatch images (for example, TVHatch and Hatch20) look for distortion with concave or convex lines near the periphery of the display. Look for irregular spacing on the cross hatch patterns.
 - When testing photometry such as chrominance, use the [TVBar100 & TVBar_75 \(TV formats only\)](#), [TVSplBar](#), [SMPTE133](#), or [SMPTEbar](#) images. Look for missing bars which may indicate a dead or unconnected channel. Also, look at the transitions between the bars; they should be sharp and distinct. Each bar also should be uniform in color and intensity across its entire width.
 - When testing luminance, you can use the Pluge image.
 - When testing focus with the Focus images, the characters in all areas of the display should be well-formed and in focus.
 - When testing resolution with the Grill images, you should be able to see individual and distinct stripes in all areas of the display at all four resolutions. When testing for resolution with the Burst image, the peak intensities of all of the bursts should match the white reference level. The darkest portions between the peaks should match the black reference level.

- When testing for centering, use the Outline and [TVoutLin](#) images. The detailed methods for verifying centering with the Outline images ([Outline0](#), [Outline1](#), [Outline2](#), [Outline3](#)) are provided in Appendix B, “[Image Reference](#).”
- When testing for high voltage regulation with the [Regulate](#) image, observe the outline at the edges of the image. It should stay in place and not pull away from the area of the large, white blinking patch (when it appears).

Note: *You can customize your 882 to run through a specified set of formats and images automatically or manually by creating test sequences. See Chapter 8, “[Working with Test Sequences](#).” for details.*

Testing analog component video SDTV (CE) CRTs

This section describes how to test CRT televisions with standard definition component video inputs. The examples show the 882C. However there are notes that describe the differences related to the 882D.

To set up the 882 to test an analog component video SDTV display:

1. Connect a VGA-to-RCA cable between the VGA connector on the 882 and the YPbPr inputs on the display under test.
2. Identify the component television formats to test. These formats are listed after the composite television formats in the 882's default Source list. Begin with the first format in the range of standard definition component television formats (480i).
3. Determine additional formats to test based on the resolution of the television display. The television specification sheet will provide information on what resolutions to test. It is necessary to test only those resolutions with the supported scanning type (typically, interlaced for a standard definition television).
4. Determine the images to test. For analog CRTs you typically want to select images to test for geometry, focusing, photometry, resolution, cross talk, centering, EMI, and regulation characteristics. For more details on what images test these specific display attributes, see ["Selecting image"](#) on page 47 or Appendix B, ["Image Reference."](#)

To activate the VGA interface on the output port:

1. Press the **Interface** key. A listing of signal interfaces appears on the 882's display as shown below on the 882C).

* VGA	CVBS
HDMI-D	S-VIDEO
HDMI-H	SDI

2. Choose the **VGA** item by pressing the adjacent soft key. The interface is activated and the port outputs the currently selected image and format. An asterisk is shown beside the selected interface.

Alternatively, to activate the interface through the command line interface, enter the following commands:

```
XVSI 9          // Selects the VGA interface
ALLU           // Applies the interface setting to the 882
```

If you are using the 882D generator use the DVI-A interface selection.

To verify the test set-up:

1. Press the **Source** key to access the list of formats.

2. Choose a standard component format (for example, 480i) by pressing the adjacent soft key.

Alternatively, you can load the format with the following command:

```
FMTL 480i  
FMTU
```

3. Press the **Content** key to access the list of images.
4. Choose a suitable image (for example, SMPTE133) by pressing the adjacent soft key.

Alternatively, you can load the image with the following command:

```
IMGL SMPTE133  
IMGU
```

5. Verify that the image appears on the display under test.

To test the display:

1. Press the **Source** key and select the first test format.

Alternatively, you can load the format with the following command:

```
FMTL format_name  
FMTU
```

2. Press the **Content** key and select the first test image.

Alternatively, you can load the image with the following command:

```
IMGL image_name  
IMGU
```

3. Repeat steps 1 and 2 for all formats and test images. Use the following guidelines to verify proper operation:
 - When testing geometry with the Hatch images (for example, TVHatch and Hatch20), look for distortion with concave or convex lines near the periphery of the display. Look for irregular spacing on the cross hatch patterns.
 - When testing photometry such as chrominance, use the [TVBar100 & TVBar_75 \(TV formats only\)](#), [ColorBar](#), [SMPTE133](#), or [SMPTEbar](#) images. Look for missing bars which may indicate a dead or unconnected channel. Also, look at the transitions between the bars; they should be sharp and distinct. Each bar also should be uniform in color and intensity across its entire width.
 - When testing luminance you can use the [SMPTE133](#) (grayscale portion) image. To test gamma correction you can use the [SMPTE133](#) (checkbox portion) image. The detailed methods for verifying these parameters on the [SMPTE133](#) image are provided in Appendix B, “[Image Reference](#).”
 - When testing focus with the Focus or Text images, the characters in all areas of the display should be well-formed and in focus.
 - When testing resolution with the Grill images, you should be able to see individual and distinct stripes in all areas of the display at all four resolutions.

- When testing for centering use the TVOutline and Outline images. The detailed methods for verifying centering with the Outline images ([Outline0](#), [Outline1](#), [Outline2](#), [Outline3](#)) are provided in Appendix B, “[Image Reference](#).”
- When testing for high voltage regulation with the [Regulate](#) image, observe the outline at the edges of the image. It should stay in place and not pull away from the area of the large white blinking patch (when it appears).

Note: *You can customize your 882 to run through a specified set of formats and images automatically or manually by creating test sequences. See Chapter 8, “[Working with Test Sequences](#).” for details.*

Testing digital component video HDTV (CE) FPDs

This section describes how to test digital DVI and HDMI component video for HDTV flat panel displays. The display responses shown as examples in the procedures use the 882C and 882E. However, you can also test dual-link digital component video with DVI using the 882D. The different selection options are provided for the 882D throughout the procedure.

DVI interface testing

To set up the 882 to test a digital DVI component video HDTV display:

1. Connect an HDMI to DVI cable between the HDMI OUT (1 or 2) connector on the 882 and the DVI connector on the television display under test.

Note: If the display under test has a DVI-D connector, you will need a DVI-I to DVI-D adapter.

2. Identify the high-definition component television formats to test. These formats are listed after the composite television formats in the 882's default Source list. Begin with the first format (720p) in the range of high definition component television formats. See ["Setting Source list of formats"](#) on page 43.
3. Determine additional formats to test based on the resolution of the television display. The television product specification sheet will provide information on what resolutions to test. It is necessary to test only those resolutions with the supported scanning type (typically interlaced for a high definition television).
4. Determine the images to test. For digital television flat panel displays, you would typically want to select images to test for pixel anomalies, persistence, photometry, and resolution-related problems. For more details on which images test these specific display attributes, see ["Selecting image"](#) on page 47 or Appendix B, ["Image Reference."](#)

To activate the HDMI-D interface on the output port:

1. Press the **Interface** key. A listing of signal interfaces appears on the 882's display as shown below.

* VGA	CVBS
HDMI-D	S-VIDEO
HDMI-H	SDI

2. Choose the **HDMI-D** item by pressing the adjacent soft key. The interface is activated and the port outputs the currently selected image and format.

Alternatively, to activate the interface through the command line interface, enter the following commands:

```
XVSI 3          // Selects the HDMI-D interface
ALLU           // Applies the interface setting to the 882
```

If you are using the 882D you can select either HDMI-D or DVI-D interface. The DVI-D option provide dual link, the HDMI-D offers signal link only.

To verify the test set-up:

1. Press the **Source** key to access the list of formats.
2. Choose a high definition component format (for example, 720p50) by pressing the adjacent soft key.

Alternatively, you can load the format with the following command:

```
FMTL 720p50
FMTU
```

3. Press the **Content** key to access the list of images.
4. Choose a suitable image (for example, SMPTE133) by pressing the adjacent soft key.

Alternatively, you can load the image with the following command:

```
IMGL SMPTE133
IMGU
```

To test the display:

1. Press the **Source** key and select the first test format.

Alternatively, you can load the format with the following command:

```
FMTL format_name
FMTU
```

2. Press the **Content** key and select the first test image.

Alternatively, you can load the image with the following command:

```
IMGL image_name
IMGU
```

3. Repeat steps 1 and 2 for all formats and test images. Use the following guidelines to verify proper operation:
 - When testing photometry such as chrominance, use the [ColorBar](#), [SMPTE133](#), or [SMPTEbar](#) images. Look for missing bars which may indicate a dead or unconnected channel. Also, look at the transitions between the bars; they should be sharp and distinct. Each bar also should be uniform in color and intensity across its entire width.
 - When testing luminance, you can use the [SMPTE133](#) (grayscale) images. To test gamma correction, you can use the [SMPTE133](#) (checkbox) image. The detailed

methods for verifying these parameters on the [SMPTE133](#) image are provided in Appendix B, “[Image Reference](#).”

- When testing for centering, use the Outline images. The detailed methods for verifying centering with the Outline images ([Outline0](#), [Outline1](#), [Outline2](#), [Outline3](#)) are provided in Appendix B, “[Image Reference](#).”
- When testing resolution with the Grill images, you should be able to see individual and distinct stripes in all areas of the display at all four resolutions.
- When testing for pixel anomalies, use the Flat, Raster, and Ramp images. Use the Raster and Flat images to look for pixels that may be stuck on or off, respectively. The luminance should increase uniformly for the Ramp image. Also look for sparkles indicating problems with sampling.
- When testing for persistence with the animated images ([Cubes](#) and [Persist](#)), look for bleeding or trails in the wake of the moving object.

Note: *You can customize your 882 to run through a specified set of formats and images automatically or manually by creating test sequences. See Chapter 8, “[Working with Test Sequences](#).” for details.*

HDMI interface testing

To set up the 882 to test a digital HDMI component video HDTV display:

1. Connect an HDMI to HDMI cable between the HDMI OUT (1 or 2) connector on the 882 and the HDMI connector on the television display under test.
2. Identify the high-definition component television formats to test. These formats are listed after the composite television formats in the 882’s default Source list. Begin with the first format (720p) in the range of high definition component television formats. See “[To select a format](#).” on page 45.
3. Determine additional formats to test based on the resolution of the television display. The television product specification sheet will provide information on what resolutions to test. It is necessary to test only those resolutions with the supported scanning type (typically interlaced for a high definition television).
4. Determine the images to test. For digital television flat panel displays, you would typically want to select images to test for pixel anomalies, persistence, photometry, and resolution-related problems. For more details on which images test these specific display attributes, see “[Selecting image](#)” on page 47 or Appendix B, “[Image Reference](#).”

To activate the HDMI-H interface on the output port:

1. Press the **Interface** key. A listing of signal interfaces appears on the 882's display as shown below.

* VGA	CVBS
HDMI-D	S-VIDEO
HDMI-H	SDI

2. Choose the **HDMI-H** item by pressing the adjacent soft key. The interface is activated and the port outputs the currently selected image and format.

Alternatively, to activate the interface through the command line interface, enter the following commands:

```
XVSI 4          // Selects the HDMI-H interface
ALLU           // Applies the interface setting to the 882
```

To verify the test set-up:

1. Press the **Source** key to access the list of formats.
2. Choose a high definition component format (for example, 720p50) by pressing the adjacent soft key.

Alternatively, you can load the format with the following command:

```
FMTL 720p50
FMTU
```

3. Press the **Content** key to access the list of images.
4. Choose a suitable image (for example, SMPTE133) by pressing the adjacent soft key.

Alternatively, you can load the image with the following command:

```
IMGL SMPTE133
IMGU
```

To test the display:

1. Press the **Source** key and select the first test format.

Alternatively, you can load the format with the following command:

```
FMTL format_name
FMTU
```

2. Press the **Content** key and select the first test image.

Alternatively, you can load the image with the following command:

```
IMGL image_name
IMGU
```

3. Repeat steps 1 and 2 for all formats and test images. Use the following guidelines to verify proper operation:

- When testing photometry such as chrominance, use the [ColorBar](#), [SMPTE133](#), or [SMPTEbar](#) images. Look for missing bars which may indicate a dead or unconnected channel. Also, look at the transitions between the bars; they should be sharp and distinct. Each bar also should be uniform in color and intensity across its entire width.
- When testing luminance, you can use the [SMPTE133](#) (grayscale) images. To test gamma correction, you can use the [SMPTE133](#) (checkbox) image. The detailed methods for verifying these parameters on the [SMPTE133](#) image are provided in Appendix B, “[Image Reference](#).”
- When testing for centering, use the Outline images. The detailed methods for verifying centering with the Outline images ([Outline0](#), [Outline1](#), [Outline2](#), [Outline3](#)) are provided in Appendix B, “[Image Reference](#).”
- When testing resolution with the Grill images, you should be able to see individual and distinct stripes in all areas of the display at all four resolutions.
- When testing for pixel anomalies, use the Flat, Raster, and Ramp images. Use the Raster and Flat images to look for pixels that may be stuck on or off, respectively. The luminance should increase uniformly for the Ramp image. Also look for sparkles indicating problems with sampling.
- When testing for persistence with the animated images ([Cubes](#) and [Persist](#)), look for bleeding or trails in the wake of the moving object.

Note: You can customize your 882 to run through a specified set of formats and images automatically or manually by creating test sequences. See Chapter 8, “[Working with Test Sequences](#).” for details.

Testing SDI and HD-SDI digital component video studio displays

This section describes how to test SDI and HD-SDI digital component video for HDTV flat panel displays.

To set up the 882 to test a digital (SDI/HD-SDI) component video HDTV display:

1. Connect a coaxial cable between the SDI/HD-SDI BNC connector on the 882 and the SDI/HD-SDI BNC connector on the studio display under test.
2. Identify the component studio formats to test. These formats are listed after the composite studio formats in the 882's default Source list. See "[Setting Source list of formats](#)" on page 43.
3. Determine additional formats to test based on the resolution of the studio display. The studio monitor product specification sheet will provide information on what resolutions to test. It is necessary to test only those resolutions with the supported scanning type.
4. Determine the images to test. For digital studio displays, you would typically want to select images to test for pixel anomalies, persistence, photometry, and resolution-related problems. For more details on which images test these specific display attributes, see "[Selecting image](#)" on page 47 or Appendix B, "[Image Reference](#)."

To activate the SDI/HD-SDI interface on the output port:

1. Press the **Interface** key. A listing of signal interfaces appears on the 882's display as shown below.

* VGA	CVBS
HDMI-D	S-VIDEO
HDMI-H	SDI

2. Choose the **SDI** item by pressing the adjacent soft key. The interface is activated and the port outputs the currently selected image and format.

Alternatively, to activate the interface through the command line interface, enter the following commands:

```
XVSI 8          // Selects the SDI interface
ALLU           // Applies the interface setting to the 882
```

To verify the test set-up:

1. Press the **Source** key to access the list of formats.
2. Choose a component studio format (for example, 720p50) by pressing the adjacent soft key.

Alternatively, you can load the format with the following command:

```
FMTL 720p50
FMTU
```

3. Press the **Content** key to access the list of images.
4. Choose a suitable image (for example, SMPTE133) by pressing the adjacent soft key.

Alternatively, you can load the image with the following command:

```
IMGL SMPTE133
IMGU
```

To test the display:

1. Press the **Source** key and select the first test format.

Alternatively, you can load the format with the following command:

```
FMTL format_name
FMTU
```

2. Press the **Content** key and select the first test image.

Alternatively, you can load the image with the following command:

```
IMGL image_name
IMGU
```

3. Repeat steps 1 and 2 for all formats and test images. Use the following guidelines to verify proper operation:
 - When testing photometry such as chrominance, use the [ColorBar](#), [SMPTE133](#), or [SMPTEbar](#) images. Look for missing bars which may indicate a dead or unconnected channel. Also, look at the transitions between the bars; they should be sharp and distinct. Each bar also should be uniform in color and intensity across its entire width.
 - When testing luminance, you can use the [SMPTE133](#) (grayscale) images. To test gamma correction, you can use the [SMPTE133](#) (checkbox) image. The detailed methods for verifying these parameters on the [SMPTE133](#) image are provided in Appendix B, “[Image Reference](#).”
 - When testing for centering, use the Outline images. The detailed methods for verifying centering with the Outline images ([Outline0](#), [Outline1](#), [Outline2](#), [Outline3](#)) are provided in Appendix B, “[Image Reference](#).”
 - When testing resolution with the Grill images, you should be able to see individual and distinct stripes in all areas of the display at all four resolutions.
 - When testing for pixel anomalies, use the Flat, Raster, and Ramp images. Use the Raster and Flat images to look for pixels that may be stuck on or off, respectively. The luminance should increase uniformly for the Ramp image. Also look for sparkles indicating problems with sampling.
 - When testing for persistence with the animated images ([Cubes](#) and [Persist](#)), look for bleeding or trails in the wake of the moving object.

Note: You can customize your 882 to run through a specified set of formats and images automatically or manually by creating test sequences. See Chapter 8, [“Working with Test Sequences.”](#) for details.

Using the Image Caching feature

The Image Cache feature enables you to render images quickly. This feature is ideal for applications, such as production line testing, which require rapid image rendering.

The Image Cache features renders a number of images in advance and stores them in memory for immediate recall. The number of images that can be stored in cache depends on the resolution and bit depth of the chosen format. The cached images are stored in video RAM, and are lost on power cycle, reboot, or issuance of the ICHC command.

Usage of cached images can be divided into two sets of operations. First, the desired formats and images are loaded in the conventional non-cached manner. As each image is displayed, it can be saved in the cache to be later recalled in the same format. When all images have been saved with the proper video formats, they can be quickly recalled from the cache and displayed.

Use the procedure below to render images quickly with the Image Cache feature.

To test a sink with the Image Caching feature:

1. Load the cache with some images in 2 different formats.

```
IMGX:SRC Render // specify normal render mode
ICHC // clear the cache
FMTL DMT0660 // select first format
FMTU // use this format
IMGL SmpTeBar // load image SmpTeBar
IMGU // use this image
ICHA IMG1 // save this image to cache as IMG1 for DMT0660
IMGL Master // load image Master
IMGU // use this image
ICHA IMG2 // save this image to cache as IMG2 for DMT0660
IMGL TVBarH // load image TVBarH
IMGU // use this image
ICHA IMG3 // save this image to cache as IMG3 for DMT0660
FMTL 720p60 // load 720p60 format
FMTU // use this format
IMGL SmpTeBar // load image SmpTeBar
IMGU // use this image
ICHA IMG4 // save this image to cache as IMG4 for 720p60
IMGL Ramp_B // load image Ramp_B
IMGU // use this image
ICHA IMG5 // save this image to cache as IMG5 for 720p60
IMG:SRC Cache // enable image caching
```

2. Display these images from cache.

```
FMTL DMT0660 // load format DMT0660
FMTU // use this format without redrawing
ICHL IMG3 // load cached TVBarH for DMT0660
ICHU // fast display of TVBarH from cache
ICHL IMG1 // load cached SmpTeBar for DMT0660
ICHU // fast display of SmpTeBar from cache
```



```
FMTL 720p60      // load format 720p60
FMTU 0           // use format without redrawing
ICHL IMG4        // load cached SmpteBar for 720p60
ICHU             // fast display of SmpteBar from cache
ICHL IMG5        // load cached Ramp_B for 720p60
ICHU             // fast display of Ramp_B
FMTL DMT0660     // load format DMT0660
FMTU 0           // use format without redrawing
ICHL IMG2        // load cached Master for DMT0660
ICHU             // fast display of Master
FMTU             // revert to normal rendering, reset cache
```

3. Return to normal rendering mode.

```
IMGX:SRC Render // specify normal render mode
```

Using the AuxTest image

This section describes the AuxTest composite test image used in production. This image tests an HDMI sink for CEC, EDID and HDCP at the same time. The CEC test is a simple ping test. The HDCP test is an authentication test. The EDID test is a checksum test.

Use the procedure below to test a sink for CEC, EDID and HDCP.

To test an HDMI sink for CEC, EDID and HDCP:

1. Physically connect a monitor to the HDMI Tx port.

There are two AuxTest images. AuxTest1 tests out the HDMI Tx port1 and AuxTest2 tests out the HDMI Tx port2:

2. Press the **Interface** key. A listing of signal interfaces appears on the 882's display as shown below.

* VGA	CVBS
HDMI-D	S-VIDEO
HDMI-H	SDI

3. Choose the **HDMI-H** item by pressing the adjacent soft key. The interface is activated and the port outputs the currently selected image and format.

Alternatively, to activate the interface through the command line interface, enter the following commands:

```
XVSI 4          // Selects the HDMI-H interface
ALLU           // Applies the interface setting to the 882
```

4. Press the **Content** key and select the first AuxTest image.

Alternatively, you can load the image with the following command:

```
IMGL AuxTest1
IMGU
```

The test image is shown below. The upper left section shows the results of the EDID test which verifies the checksum. The upper right section shows the result of the CEC test which does a basic ping test and also reads the physical address of a connected

device. The section in the center shows the step by step results (11 steps) of the first phase of the HDCP authentication. Below that is the ongoing test results of the third phase of authentication, i.e. exchanging the Ri values.

```
EDID TEST RESULTS - PASSED

CEC TEST RESULTS:
Device type being tested: TV/Display
Reponse Test - PASSED

HDCP TEST RESULTS:
Step 1: Reset the transmitter and its HDCP engine - PASSED
Step 2: Initialize the transmitter - PASSED
Step 3: At transmitter generate AN - PASSED
Step 4: Write AN to receiver - PASSED
Step 5: Write the transmitters to the receiver - PASSED
Step 6: Read and verify the receiver KSV - PASSED
Step 7: Write receiver KSV to transmitter - PASSED
Step 8: Ri ready at transmitter - PASSED
Step 9: Read and compare transmitter Ri with receiver Ri - PASSED
Step 10: Generate authentication - PASSED
Step 11: Transmitting encrypted data - TESTING

Ri = 0x12CD, Ri' = 0xCD6D
PASSED
```

Using the ImageShift utility

This section describes the ImageShift utility and how to use it. The ImageShift utility allows you to set in motion any of the built-in or bitmap static images stored in the 882. Image shifting can be controlled at both the pixel level in horizontal and vertical directions, and on a per frame basis. The shift pattern can be set to either a repeated pattern or back and forth (reversed).

You can create your own imageshift files in order to specify particular image shifting configurations to invoke. This enables you to quickly invoke an image shifting set of parameters to apply.

The ImageShift function can be configured and run either through the front panel or the command line. Procedures for both are provided.

Using the ImageShift utility through the front panel

The procedure for configuring and running the ImageShift utility is provided below.

To use the ImageShift utility through the front panel:

1. Physically connect a monitor to the 882 at any of the interfaces using a suitable cable.
2. Press the **Tools** key. The Tools menu appears on the 882's display as shown below.

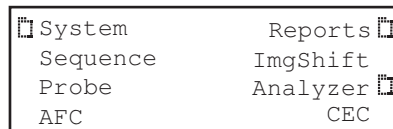

3. Choose **ImgShift** by pressing the adjacent soft key. The following menu appears on the 882's display.



This display enables you to browse for a bitmap image or a built-in image stored in cache.

4. Choose **Cache** to browse for a built-in image. The following menu appears on the 882's display.



5. Choose **Images**, and then select the image you want to use.

The image appears and begins shifting in accordance with default settings for both speed and method of shifting (either repeat or reversed). The following settings appear on the 882's display as shown below.

```

>Line           Reversed<
  HInc:  1
  VInc:  1
 *TInc:  1           Exit!
```

- a. Configure image shifting parameters by selecting a parameter using its adjacent soft key, then adjusting the value by pressing the + or - keys.

Refer to the following table for a description of the parameters used to control image shifting.

Parameter	Action
Line	Selects image shifting pattern. This can be either Reverse or Repeat. <ul style="list-style-type: none"> • Reverse moves the image in both directions in accordance with the shift parameters. • Repeat moves the image in only one direction.
HInc	Specifies number of pixels the image travels in a horizontal direction per time period.
VInc	Specifies number of lines the image travels in a vertical direction per time period.
TInc	Specifies movement to occur per N number of frames.

6. To set the starting point of the image shift, press the **Settings** key. The following settings appear on the 882's display.

```

          Path
  Start Point  ->
    X      Y
  000    000  ->
```

You can set the starting coordinates of the image shift as follows:

- a. To specify the X Start Point, position the blinking cursor on the digits of the X coordinate you wish to change. To do this, press the soft key adjacent to the arrow

- by the coordinates to move the cursor left or right until it appears on the digit in the X coordinate. Adjust the value of the setting up or down by pressing the + or - keys.
- b. To specify the Y Start Point, position the blinking cursor on the digits of the Y coordinate you wish to change. To do this, press the soft key adjacent to the arrow by the coordinates to move the cursor left or right until it appears on the digit in the Y coordinate. Adjust the value of the setting up or down by pressing the + or - keys.
7. To set the ending point of the image shift, press the soft key to the right of Start Point. The following settings appear on the 882's display.

		Path		
<-	End	Point		
	X	Y		
	100	100		->

You can set the ending coordinates of the image travel as follows:

- a. To specify the X End Point, position the blinking cursor on the digits of the X coordinate you wish to change. To do this, press the soft key adjacent to the arrow by the coordinates to move the cursor left or right until it appears on the digit in the X coordinate. Adjust the value of the setting up or down by pressing the + or - keys.
- b. To specify the Y End Point, position the blinking cursor on the digits of the Y coordinate you wish to change. To do this, press the soft key adjacent to the arrow by the coordinates to move the cursor left or right until it appears on the digit in the Y coordinate. Adjust the value of the setting up or down by pressing the + or - keys.

Note: *The movement that you see may not always correspond to the settings for HInc and VInc. The reason is that the number of shifts from start point to end point is determined by the quotient of the total travel in the horizontal (pixels) and vertical (lines) directions and the total increment defined. The lowest quotient of the two (horizontal vs. vertical) will determine how many shifts the utility will make from start point to end point. For example, if the start point is 0,0 and the end point is 100,100. An HInc setting of 10 and a VInc setting of 20 will result in 5 shift movements ($100/20 = 5$). The 882 will not produce shifts of 10 horizontal pixels per increment because it cannot move from 0 to 100 in 5 shifts by only moving 10 horizontal increments.*

8. To save the changes, press the **Enter (Options)** key. The following choices appear on the 882's display:

Apply Settings?	
Yes	Back
	No

- To save the changes, choose the **Yes** item by pressing the adjacent soft key.
- To exit without saving the changes, choose the **No** item.

- To return to the previous screen without saving the changes, choose the **Back** item.

Using the ImageShift utility through the command line interface

The procedures for configuring and running the ImageShift utility from the command line interface are given below. To run the ImageShift utility from the command line interface, you must utilize an imageshift file. An imageshift file specifies both the image and parameters necessary to run the ImageShift utility.

To create an imageshift file:

1. Establish a session with the 882 using either HyperTerminal over a serial connection or Telnet over an Ethernet LAN. See “[Configuring the 882’s serial port](#)” on page 30 or “[Establishing a Telnet session with the 882](#)” on page 33.

2. Set the path to the imageshift files using the ISHP command. For example:

```
ISHP tffs0/library/imageshifts
```

3. Create a new imageshift file using the ISHN command. For example:

```
ISHN Newshift
```

4. Define the imageshift file settings as shown in the example below:

```
ISHB //begins an imageshift editing session
XISH:SRCN /cache0/images/SMPTEBar //selects the SMPTEBar image
XISH:PATH 0,0 150,20 //sets the imageshift path x,y coordinates
XISH:TTYP 1 //sets the trace type to Repeat (1)
XISH:HINC 4 //sets the horizontal shift increment to 4
XISH:VINC 2 //sets the vertical shift increment to 2
XISH:TINC 5 //sets the time shift value to 5
ISHE //ends the imageshift editing session
```

5. Save the settings to the same imageshift file using the ISHS command, For example:

```
ISHS //saves the settings to the Newshift file
```

To run the ImageShift utility through the command line interface:

1. Establish a session with the 882 using either HyperTerminal over a serial connection or Telnet over an Ethernet LAN. See “[Configuring the 882’s serial port](#)” on page 30 or “[Establishing a Telnet session with the 882](#)” on page 33.

2. Set the path to the imageshift files using the ISHP command. For example:

```
ISHP tffs0/library/imageshifts
```

3. Enter the following commands to display the list of imageshift files.

```
ISHQ? //Displays the first 5 imageshift filenames
ISHQ? //Displays 5 more imageshift filenames
```

4. Load an imageshift file and apply the image to hardware. For example:

```
ISHL Newshift //Loads the values from the imageshift file named
              //Newshift
ISHG 1        //Initiates (gates on) the imageshift function
ISHU          //Applies the values to the hardware
```

5. Apply the imageshift file to the hardware using the ISHU command. For example:

```
ISHU          //applies the imageshift file to the hardware
```

To stop the ImageShift utility through the command line interface:

1. To stop the Imageshift enter the following command.

```
ISHG 0        //Stops (gates off) the imageshift function
```

Adjust Frequency Function

This section describes the adjust frequency control (AFC) function.

The AFC function provides you with the ability to increase or decrease the horizontal frequency (HRAT parameter) of the active video format in increments of 2%.

Use the following procedures to increase or decrease the frequency of the active format.

To utilize the AFC function:

1. Physically connect a monitor to the 882 at any of the interfaces using a suitable cable.
2. Press the **Tools** key. The Tools menu appears on the 882's display as shown below.

```
System      Reports
Sequence    ImgShift
Probe       Analyzer
AFC         CEC
```

3. Choose **AFC** by pressing the adjacent item selection key. The following display appears on the 882's display.

```
Hz Frequency Shift
-10% -----+----- +10%
          ^
H = 45000.000
```

This display enables you to increase or decrease the horizontal frequency parameter in increments of 2% using the +/- keys.

Keypad Utility

This section describes the Keypad utility and how to use it.

The keypad provides you with a quick and convenient way of changing between formats and images. The interface from the Keypad to the 882 is through the serial interface. Once connected you can change between formats and image with a single key stroke. You can also control test sequences using the Keypad.

Use the following procedures to install and operate the remote keypad.

To install and enable the keypad:

1. Shut off the 882.
2. Connect the keypad to the serial port on the 882.

The serial port is on the back of the 882 on the lower panel. It is labeled **Serial**.

3. Press the **Tools** key. The Tools menu appears on the 882's display as shown below.

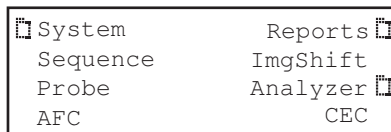

4. Choose **System** pressing the adjacent item selection key. The following display appears on the 882's display.



5. Choose **Serial** to access the menu for enabling the Keypad. The following display appears on the 882's display.

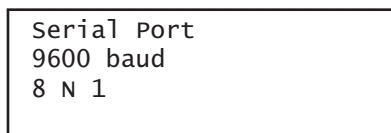

6. Press the **Options** key. The following information appears on the 882's display:

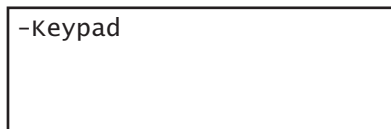

7. Press the softkey adjacent to the **Keypad** item to enable the keypad function.

A + appears next to the **Keypad** item indicating that the functionality is enabled.

To monitor the status of the keypad:

1. Press the **Tools** key. The Tools menu appears on the 882's display.

When the keypad has been enabled there is an additional item in the Tools menu. This is indicated by an arrow key. If you scroll down using the - key the following menu appears:

```
Sequence ^   ImgShift
Probe       Analyzer
AFC
Keypad
```

2. Select the **Keypad** item to view the keypad status. The screen shown below appears.

This display shows the Mode which is either normal or Sequence and the current format and image. The Exit enables you to exit from the menu without disabling the keypad function.

```
Mode: Normal   Exit!
Fmt: 720p60
IMG:Flat
```

To operate the keypad

- Use the figure below to operate the keypad. The keypad has two basic modes: 1) Normal which enables you to change the formats, images and colorimetry and 2) Sequence mode which enables you to control a running test sequence.

Normal mode key functions

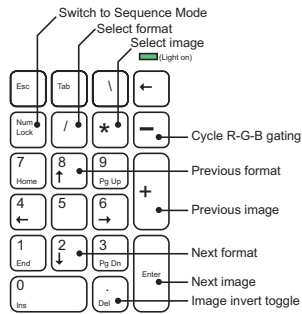

Task	Procedure
Select image from current list	Press * key, use numeric keys to specify the image number, and then press Enter.
Select next image	Press Enter.
Select previous image	Press + key.
Select alternate version of image (if available)	Press Del key.
Change R-B-G video gating	Press – key to cycle through gating combinations.
Select any format from current list	Press / key, use numeric keys to specify format number, and then press Enter.
Select next format	Press 2.
Select previous format	Press 8.
Switch to Sequence Mode	Press Num Loc key.

Sequence mode key functions

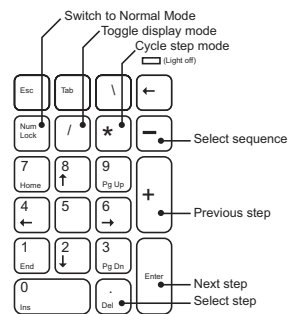

Task	Procedure
Select sequence from current list	Press – key, use numeric keys to specify sequence number, and then press Enter.
Select any step in sequence	Press Del key, use numeric keys to specify step number, and then press Enter.
Select next step	Press Enter.
Select previous step	Press + key.
Change sequence step method (step, wrap, auto, and so on)	Press * key to cycle through options.
Change DNUM settings	Press / key to cycle through options.
Switch to Normal Mode	Press Num Loc key.

3 Administrative Tasks

Topics in this chapter:

- [Overview](#)
- [Calibrating the generator](#)
- [Auto Upgrade](#)
- [Upgrading the generator locally](#)
- [Reconfiguring and booting a stalled generator](#)
- [Cloning generators](#)
- [Resetting a generator](#)
- [Viewing generator configuration information](#)

Overview

This section describes how to accomplish administrative tasks, including calibrating the generator, upgrading a generator, cloning a generator and maintaining the generator's file system.

Calibrating the generator

The 882 generator can calibrate itself. Once calibrated, the generator does not require periodic calibration. There are no physical controls to adjust. All calibration is electronic. Calibration factors are saved in non-volatile memory.

Calibrating signal level

The calibration accuracy of the generator for analog video voltage swing is specified to be ± 14 mV (or $\pm 2\%$ for a nominal 700 mV signal). Using a typical oscilloscope such as a Tektronix VM700T, which might have a swing measurement accuracy of ± 14 mV, readings should be between 674 mV to 726 mV.

You can set the analog output calibration factors to values other than those set by the generator's own self-calibration function. Each channel is calibrated using two independent, zero calibration points, and two independent, slope calibration points. Interpolation equations for the different video types are used to set the caldac values that control the output sync and voltage levels to the correct values.

You can calibrate the generator using the front panel keys or the command line interface. Follow the procedures below to calibrate the generator.

To self-calibrate the generator using the front panel:

1. (Optional) Load the outputs of the generator. Although it is not necessary to load the outputs during self-calibration, attaching a nominal load may yield a slight increase in accuracy.
2. Press the **Tools** key. The Tools menu appears on the generator's display as shown below.

System	Reports
Sequence	ImgShift
Probe	Analyzer
AFC	CEC

3. Choose the **System** item by pressing the adjacent soft key. The System menu appears. Press the - key to scroll down until the CalFactor item appears.

CalFactor	Host
Network	About
Serial	Gpib
BootFrom	Init

4. Choose the **CalFactor** item by pressing the adjacent soft key. The following items appear on the generator's display:

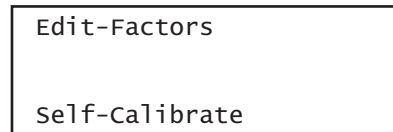

5. Choose the **Self-Calibrate** item by pressing the adjacent soft key.

During calibration, calibration factors and other information appear on the generator's display. Observe the generator's display for error messages. If an error message appears, make a note of it and call your technical support representative for further assistance.

To self-calibrate the generator using the command line interface:

1. Establish a session with the generator using either HyperTerminal over a serial connection or Telnet over an Ethernet LAN. See "[Establishing a terminal session with the 882](#)" on page 30 or "[Establishing a Telnet session with the 882](#)" on page 33.
2. At the prompt, enter the following command:

```
SCAL
```

The generator begins the calibration procedure.

To view analog calibration factors:

Enter the following command to view the analog video red, green, blue calibration factors:

```
CALF?
```

The generator presents the following in response:

```
1089, 2589, 1993, 3223, 1148, 2633, 2059, 3279, 1000, 2505, 1990, 3219,
793, 787, 3382, 3509
```

For an explanation of the calibration factors, see the [CALF?](#) command in the Appendix A, "[Command Reference](#)."

Calibrating frequency

All frequencies associated with the generator are derived from a common frequency reference, which can be calibrated using the rate calibration command [RATC](#).

To calibrate all frequencies:

1. Load a standard format and set the horizontal rate to 100 kHz.

For example, enter the following command:

```
FMTL DMT0660
HRAT 100E3
ALLU
```

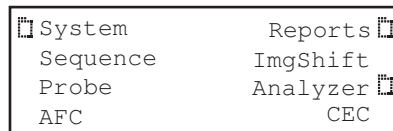

2. Measure the TTL horizontal sync frequency with the frequency counter.
3. Divide the frequency that you expect by the frequency that you measure on the frequency counter. For example, if you measure 99.9955782499875 kHz, when you expect 100.000000000kHz, then divide 100.000000000 kHz by 99.9950002499875 kHz; the result is 1.0000442194553987.
4. Enter the result into the generator. This will raise all frequencies output by the generator and make them exact. To enter the results through the front panel using the following procedures:
5. Press the **Tools** key. The Tools menu appears on the generator's display as shown below.

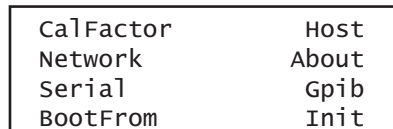

6. Choose the **System** item by pressing the adjacent soft key. The System menu appears. Press the - key to scroll down until the CalFactor item appears.

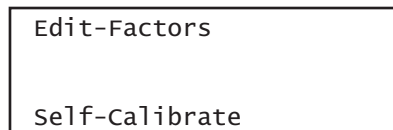

7. Choose the **CalFactor** item by pressing the adjacent soft key. The following items appear on the generator's display:



8. Choose the **Edit Factors** item by pressing the adjacent soft key. The following items appear on the generator's display:

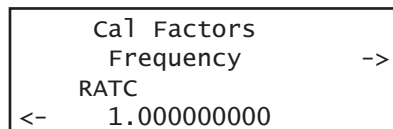

- a. Edit the RATC factor by pressing the soft keys adjacent to the bottom row until the cursor appears on the digit you want to change. Press the + or - keys to adjust the setting up or down.
- b. Press the **Enter (Options)** key to save the new setting.

Alternatively, to enter the result using the command line interface, use the RATC command. For example:

```
RATC 1.0000442194553987
```

Auto Upgrade

This section provides procedures on how to upgrade your generator using the auto upgrade feature. Note that there are also procedures for manually upgrading your 880 series generator, refer to [“Manually upgrading using PCMCIA Compact Flash card”](#) on page 109 or [“Manually upgrading the generator without using PC Card”](#) on page 111.

Quantum Data periodically makes available new firmware releases for the 880 series generators. The Auto Update utility automates the process of upgrading firmware. It guides the user through the upgrade process, checking the Quantum Data website for the latest version and installing all files in the correct location on the generator.

The Auto Update utility provides for two methods of copying the firmware files into the generator: 1) The network method and 2) the PCMCIA/Compact Flash method. These are provided below.

Auto upgrade - Network Method

The first method is the Network Upgrade. This is the recommended upgrade method. This method requires that the generator and your computer be connected by Ethernet, either via a direct crossover cable, or by being accessible to each other on a common network. The generator must possess a valid IP address, either through manual setting or via a

DHCP server on the network. The PC has to be connected to the Internet. Refer to the 880 Series User Guide, Chapter 4, “Networking 882s.” for full information on configuring a generator for network use. Refer to the diagrams below.

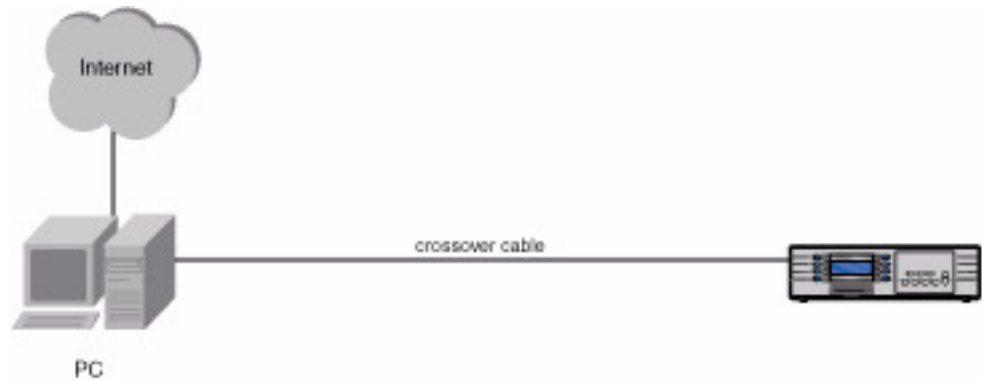
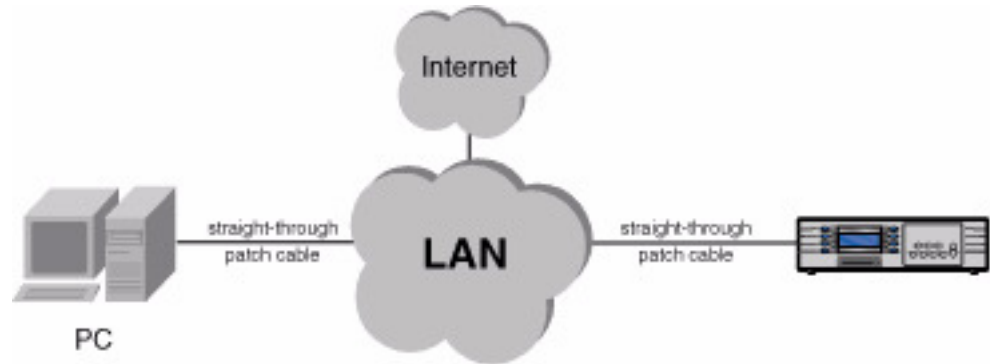

Downloading and installing the Auto Update utility:

The Auto Update utility is java-based, and requires the Java Virtual Machine (Java runtime) to be installed on the computer. This can be obtained from <http://www.java.com>.

The Auto Update utility can be downloaded from the downloads section of the Quantum Data website, at <http://www.quantumdata.com/downloads/index.asp>.

After downloading the Auto Update ZIP file, installation is simply a matter of unzipping it into a folder on your hard disk.

Running the Auto Update utility: Network Upgrade

1. Run the utility by double-clicking on **AutoUpdate.jar**. You will be presented with the following screen:

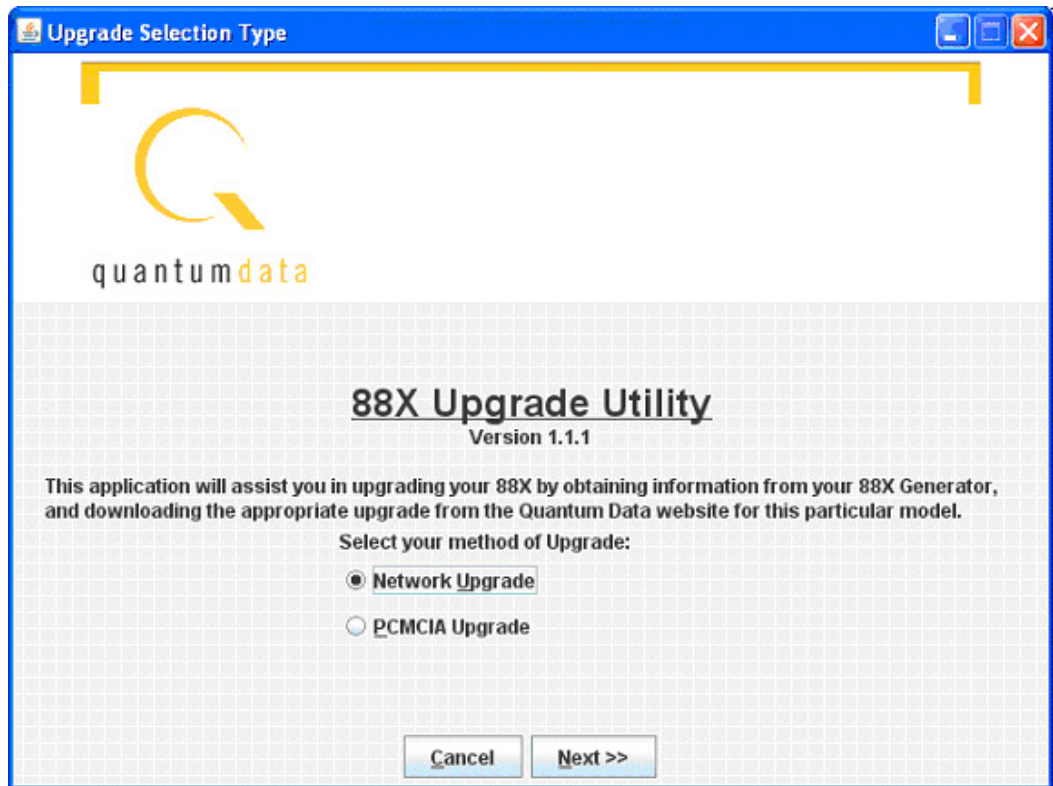

2. Select **Network Upgrade**, then **Next**. The Network Upgrade screen will appear:

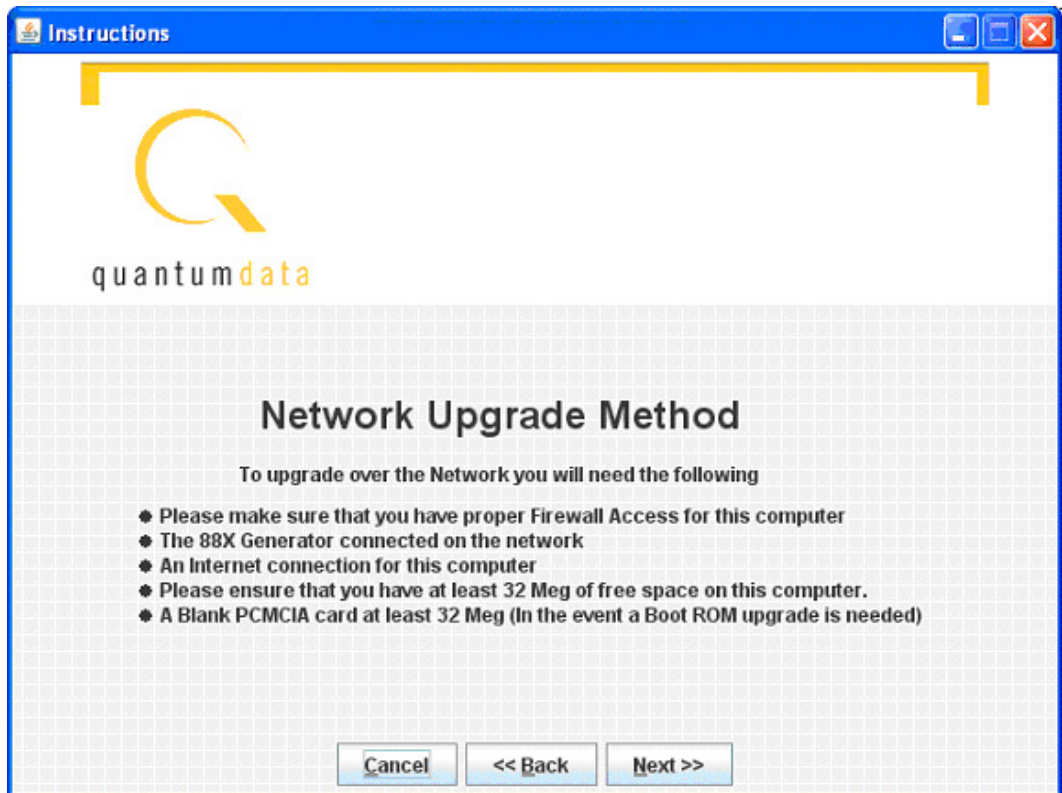

3. Make sure you have network access to the generator, then select **Next**.

Next you will have the opportunity to back up the files in the generator. If you have any custom images, formats, reports, or other files stored on the /tffs0 flash drive within the generator, they will be lost unless you choose to back up the files.

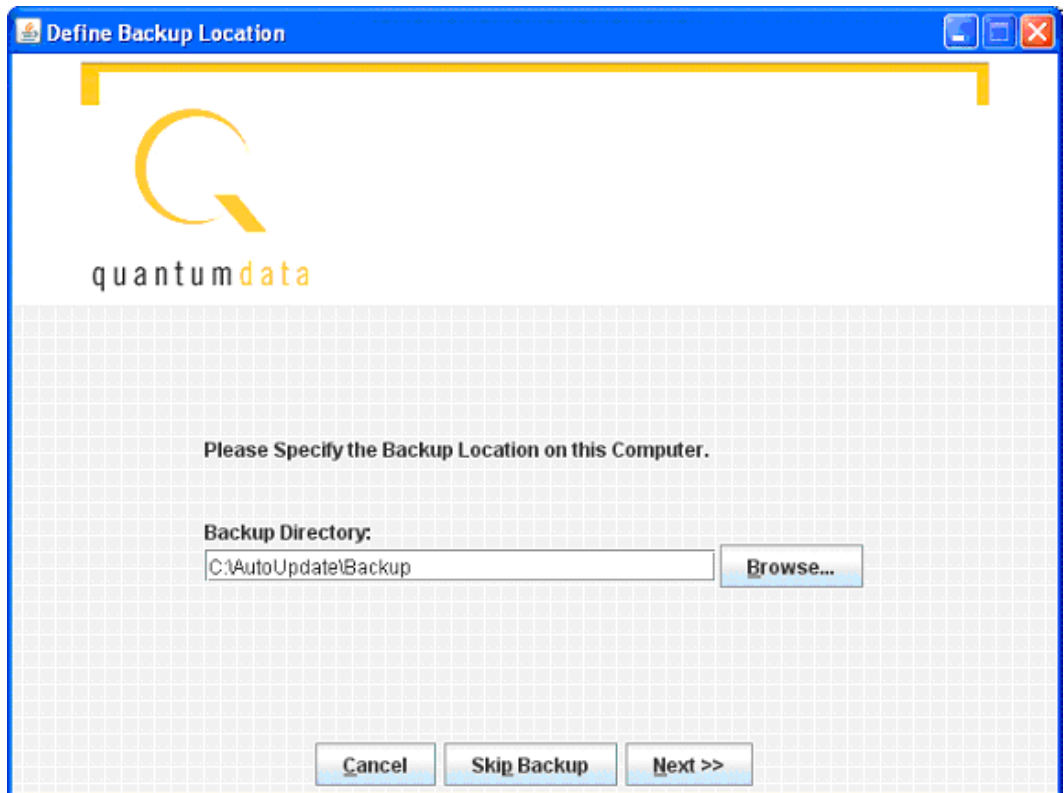

4. Optionally browse to a new backup directory, then click **Next** to begin the backup. If you don't want to back up any files from the generator, click on **Skip Backup**.
5. Next, enter the IP address for the generator:

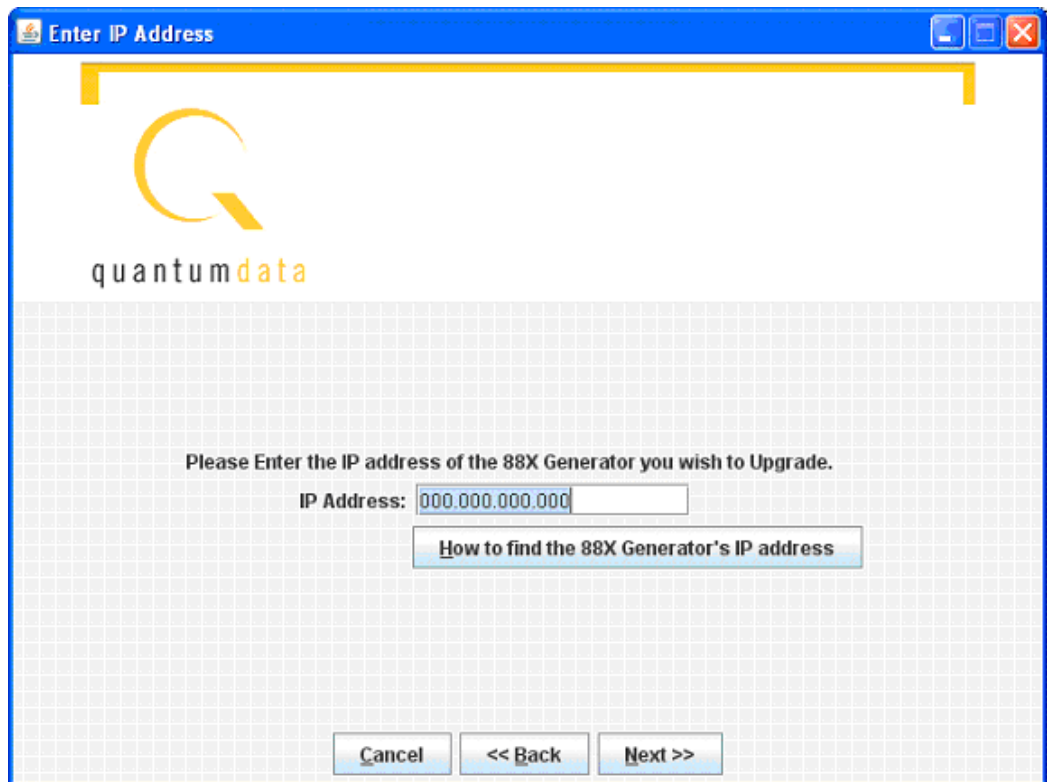

6. Click **Next** to continue.
7. If you see this screen, click **Continue With Upgrade**:

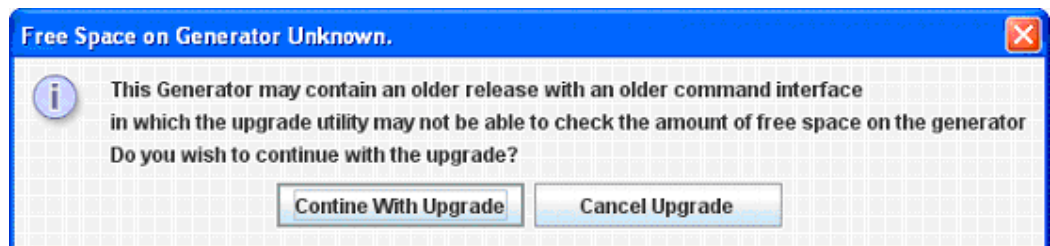

8. Next you must confirm that you are connected to the correct generator:

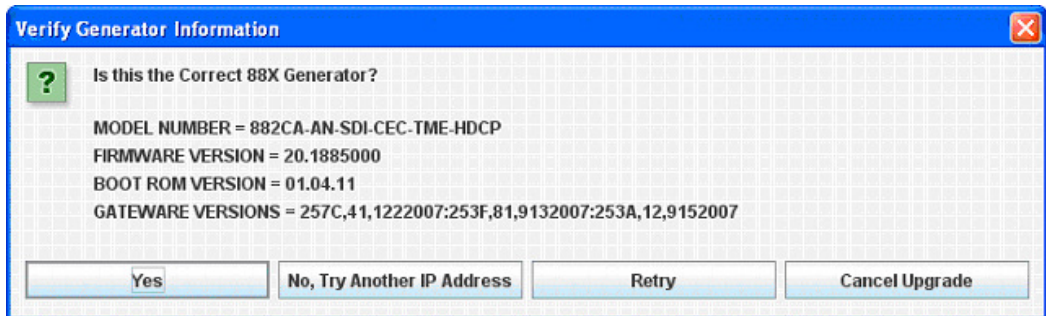

Click **Yes** to continue. Next the utility will connect to the Quantum Data website to download the current firmware version for this generator, then display the version number and wait for your confirmation.

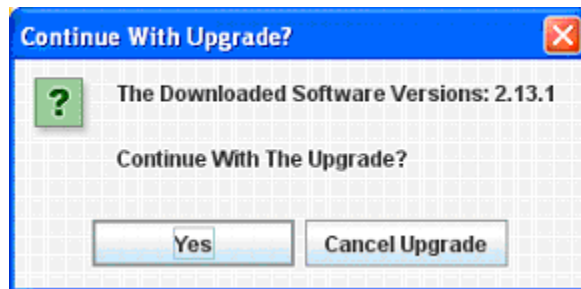

9. Click **Yes** to continue. The utility will extract the downloaded files, back up the generator's current files to the PC, and finally transfer the new files to the generator. Please don't disconnect or turn off the generator or PC until you see the final screen:

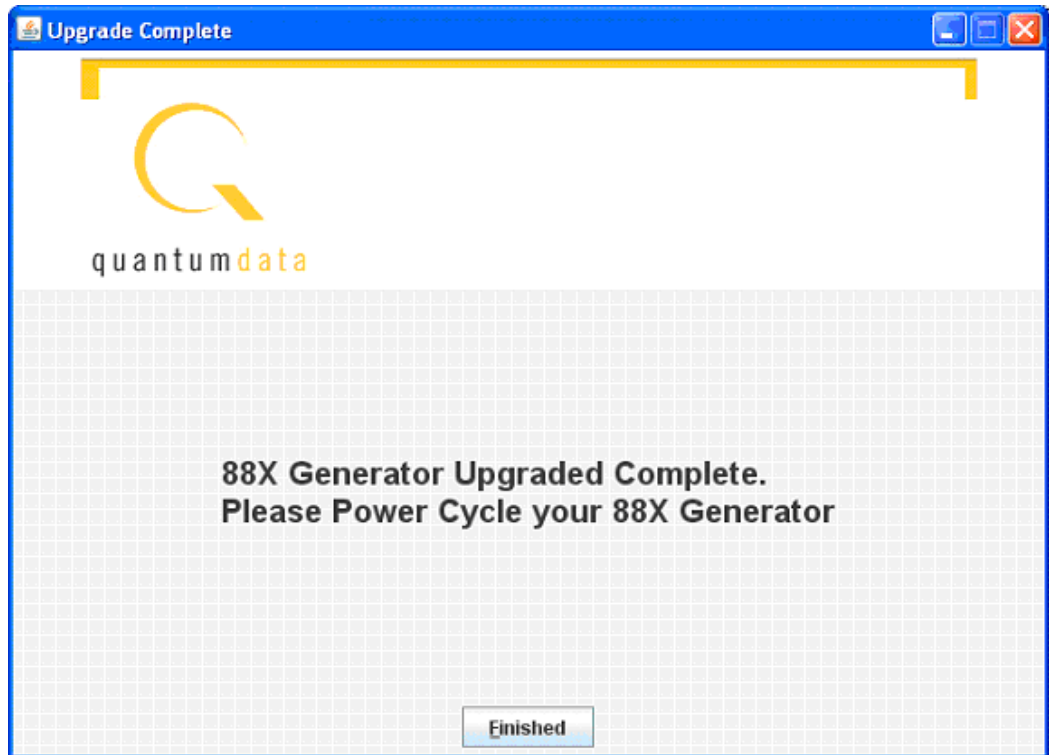

10. Now you must power cycle the generator to boot from the new firmware.

Auto upgrade - PCMCIA/Compact Flash Method

The second method of upgrading the generator using the auto upgrade feature is the PCMCIA/Compact Flash upgrade. This method is used when you connect the generator to the network and you cannot connect the PC to the generator but requires that you have a PC that is connected to the network (Internet). This method uses the PCMCIA/Compact Flash card (or compact flash with the PCMCIA/Compact Flash adapter) to transport the

upgrade files from the computer to the generator. The Auto Upgrade utility prompts the user when the PCMCIA/Compact Flash card must be moved between the computer and the generator.



Running the Auto Update utility: PCMCIA Upgrade

1. Run the utility by double-clicking on **AutoUpdate.jar**. You will be presented with the following screen:

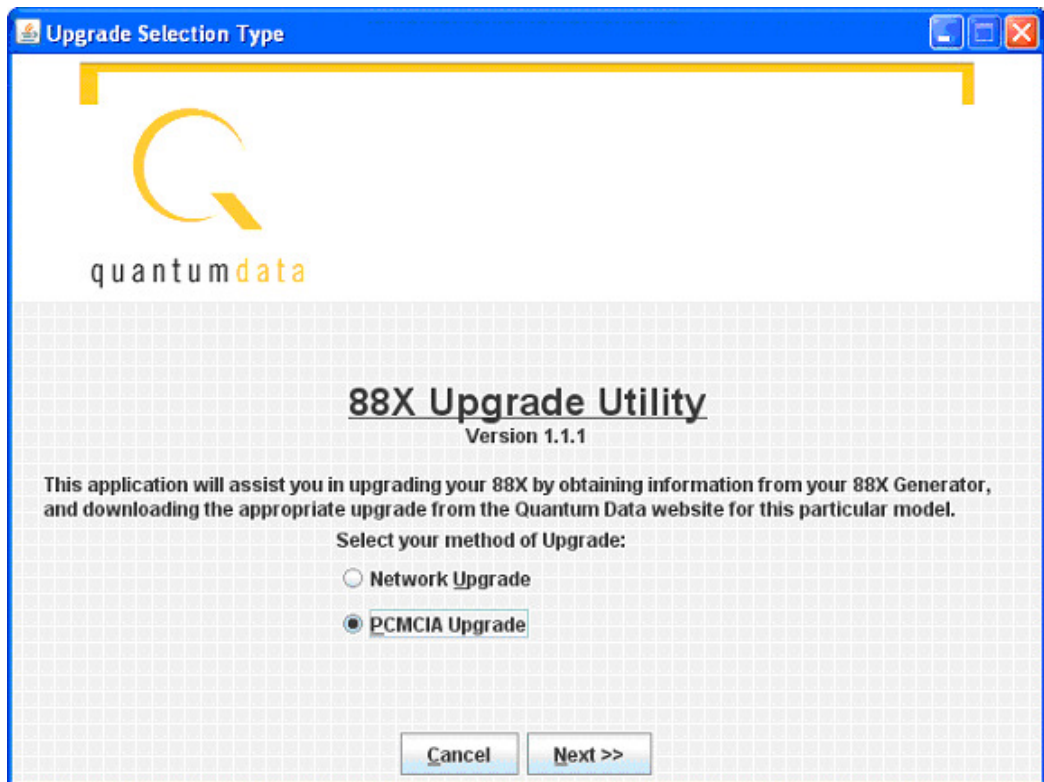

2. Select **PCMCIA Upgrade**; then click **Next**. Prepare the PCMCIA/Compact Flash card per the following screen:

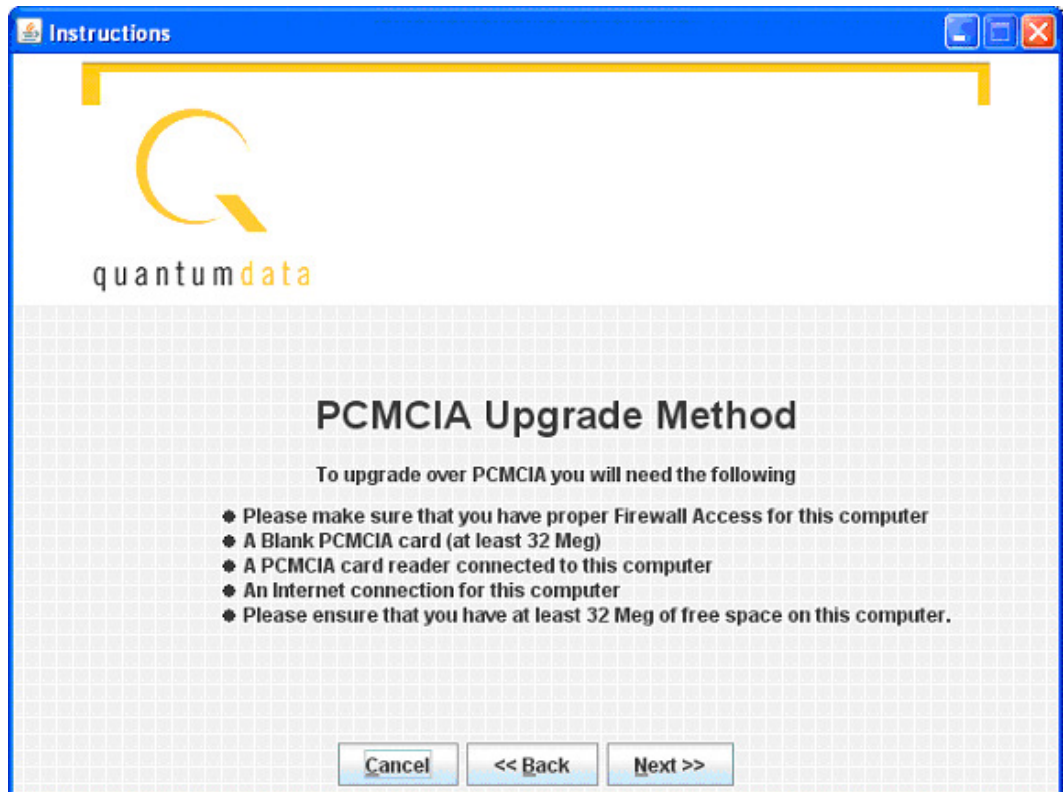

3. Click **Next**, then enter generator information (genstats) on the following screen. The button **How To Get Genstats Manually** will show you the method for reading genstats on an attached display. You can also generate an HTML genstats report by pressing **TOOLS -> Reports -> Misc -> Genstats**. You can view this report by selecting the Generated Reports link from the generator's home page; then select GenStats.
4. Enter the information exactly as presented in the genstats report. Following is an example:

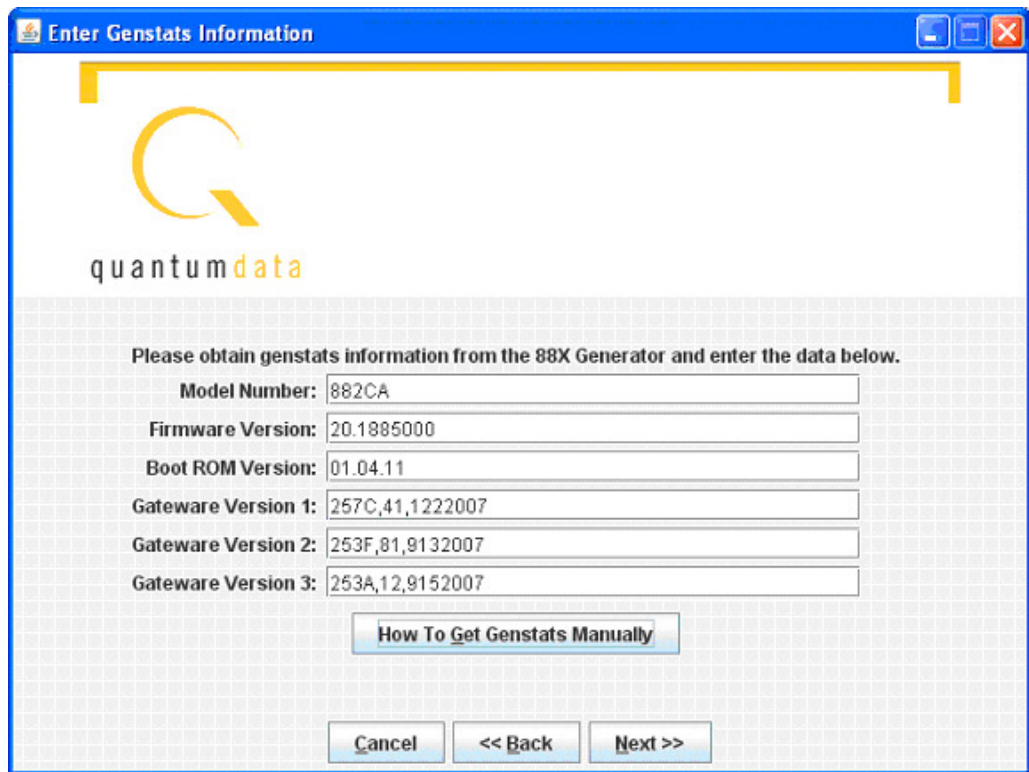

5. When this information is correct, click on **Next**.
6. The utility will download the new firmware files from the Quantum Data website, and report the version number of the release:

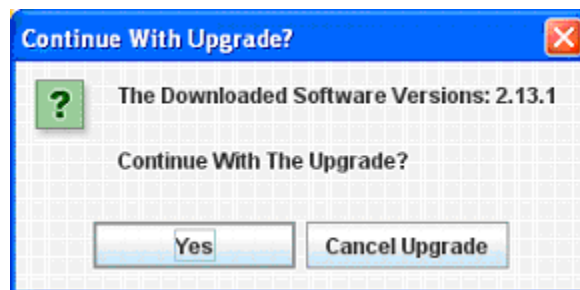

7. Click on **Yes**, and the utility will extract the individual files from the downloaded release archive. Then you will be prompted to insert a blank PCMCIA/Compact Flash card into the generator.

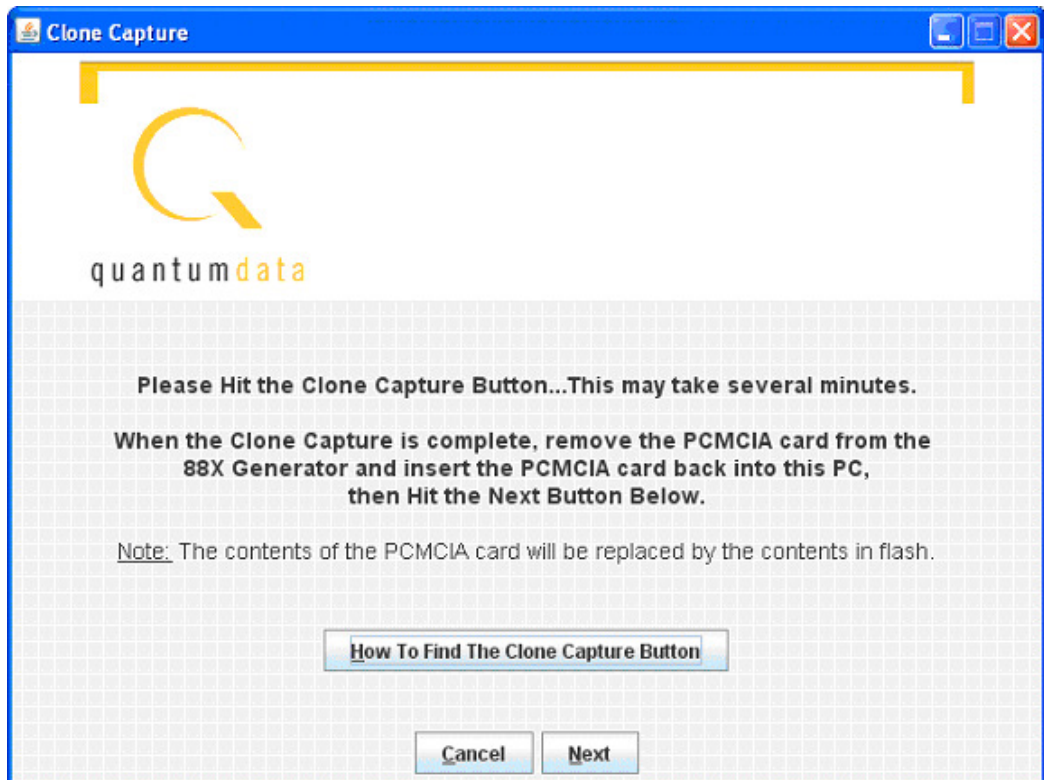
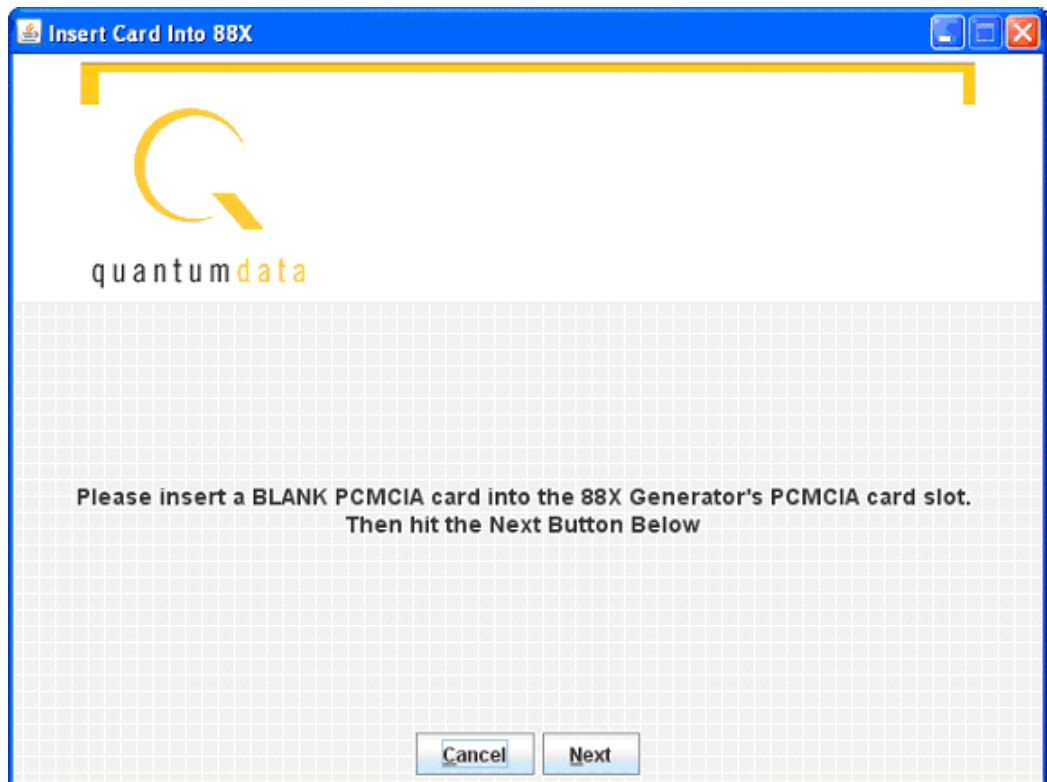

8. Next you will be prompted to hit the **Clone Capture button (Tools -> System -> Clone -> Capture.)** This will cause the generator to back up the internal files to the PCMCIA/Compact Flash card. When this process is complete, insert the card into the computer and click on **Next**.
9. Then you will be asked to specify the location of the PCMCIA/Compact Flash drive on the computer. You can type the drive letter into the space provided (such as G:\) or you can browse to the location. In either case, you must specify the root of the PCMCIA/Compact Flash card.

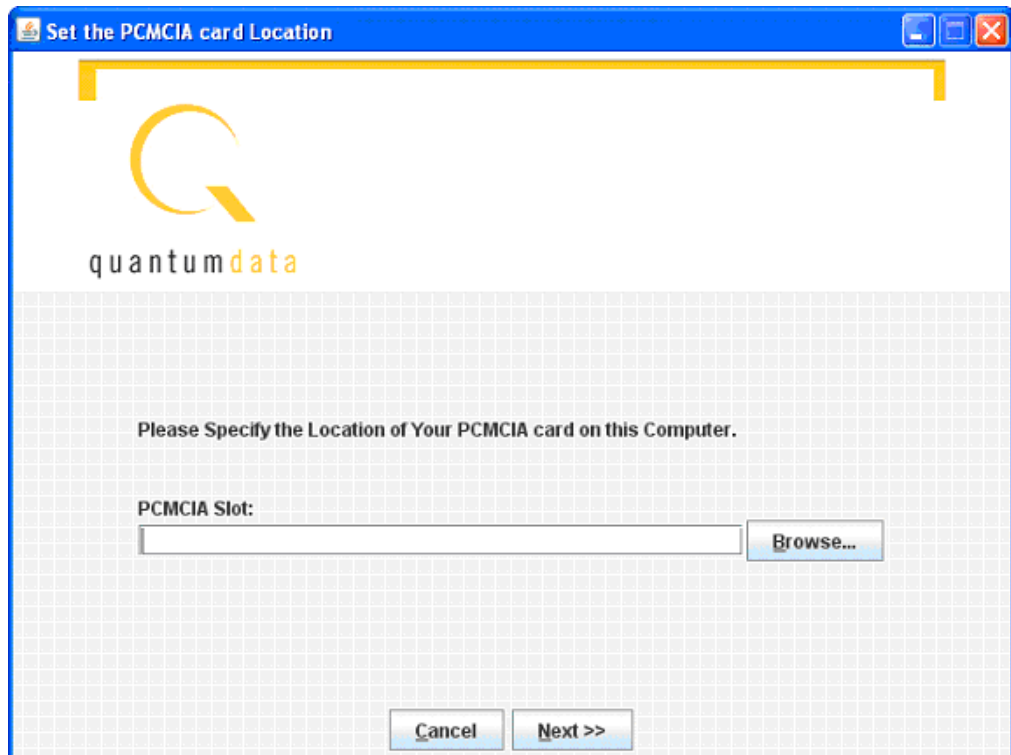

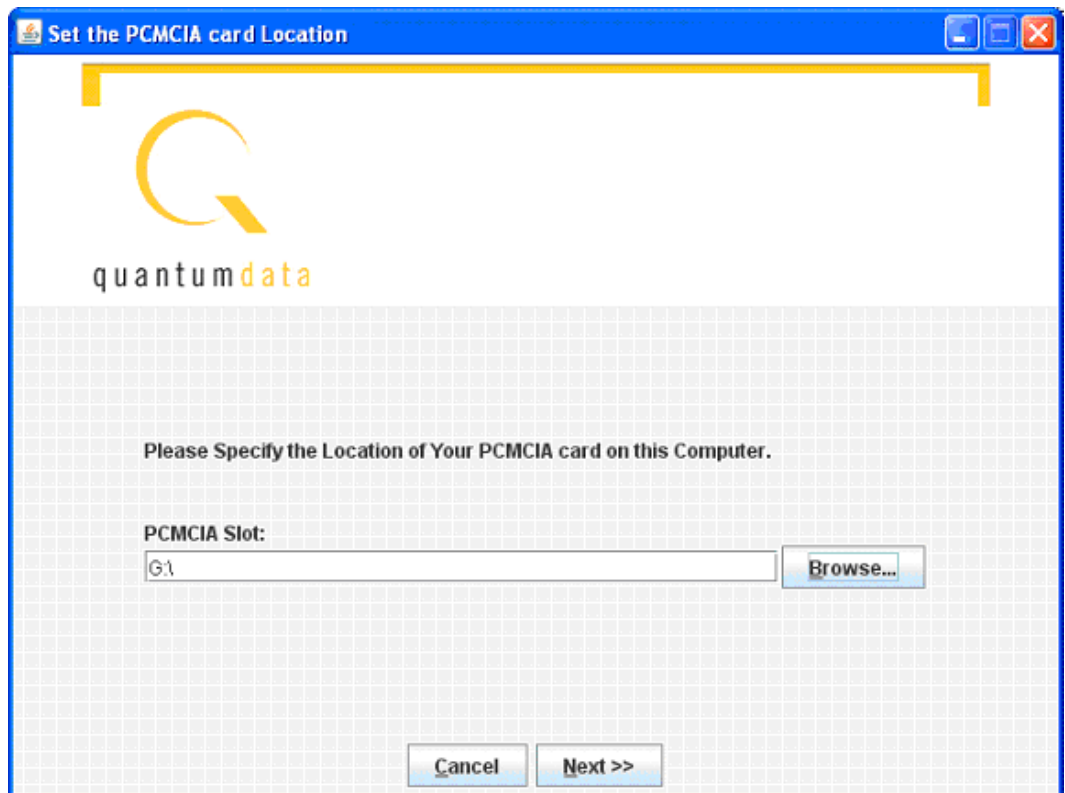
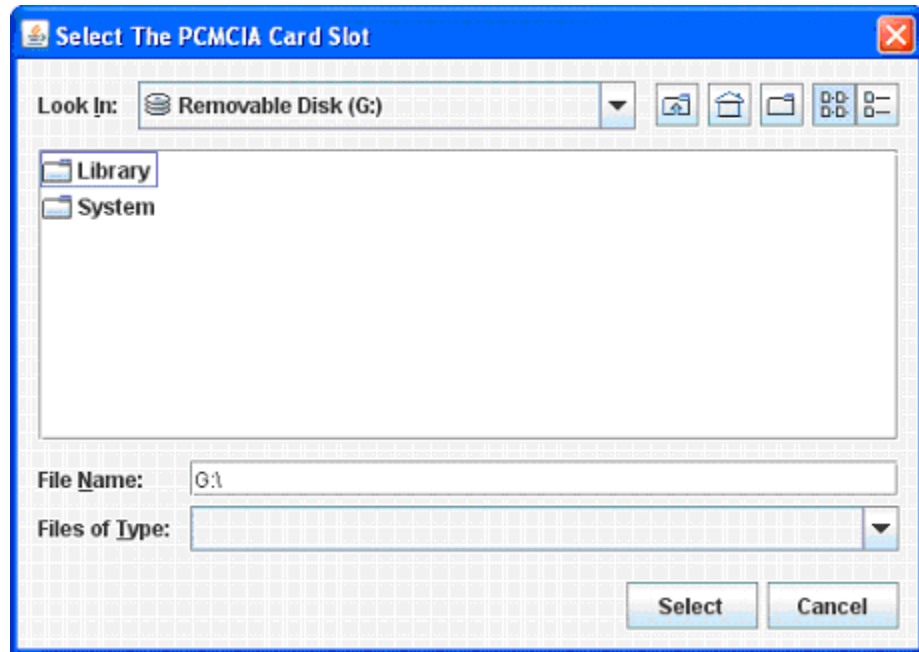

10. When the drive address is selected, click **Next**, and the backup files will be copied from the card onto the PC. When the backup is completed, the new release files will be

copied onto the card. Then you will be prompted to insert the card back into the generator.

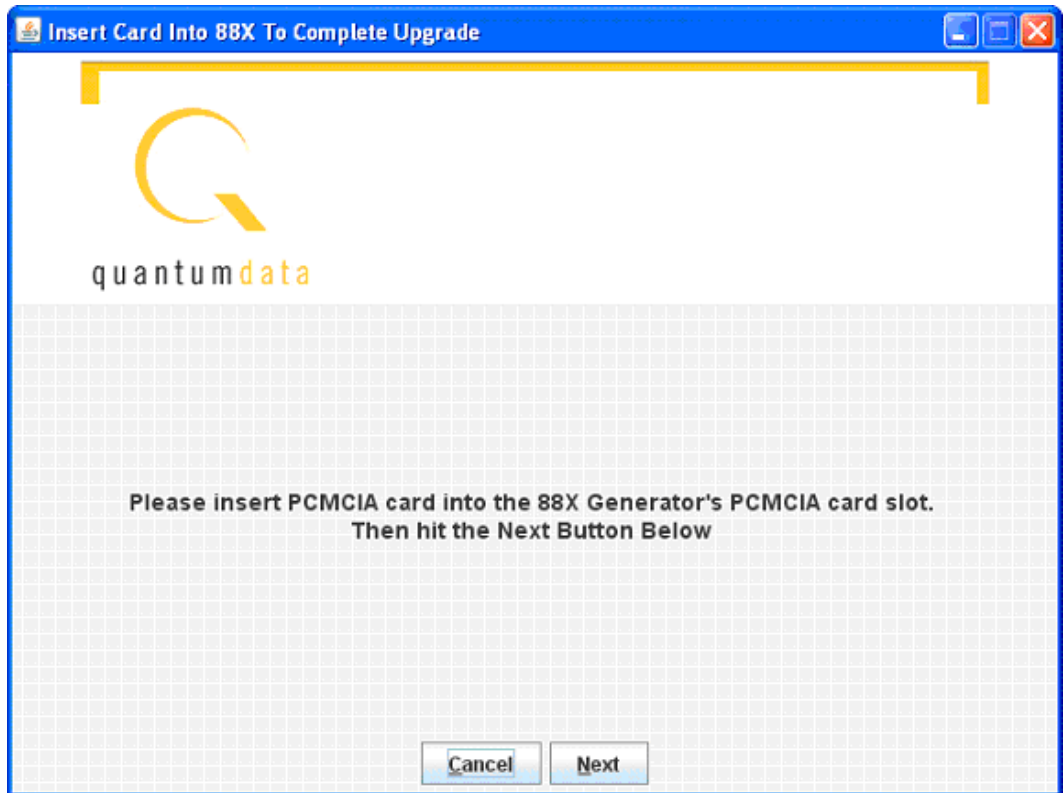

11. Click Next, and you will see the following screen instructing you to initiate the clone restore process by pressing **Tools -> System -> Clone -> Restore**.

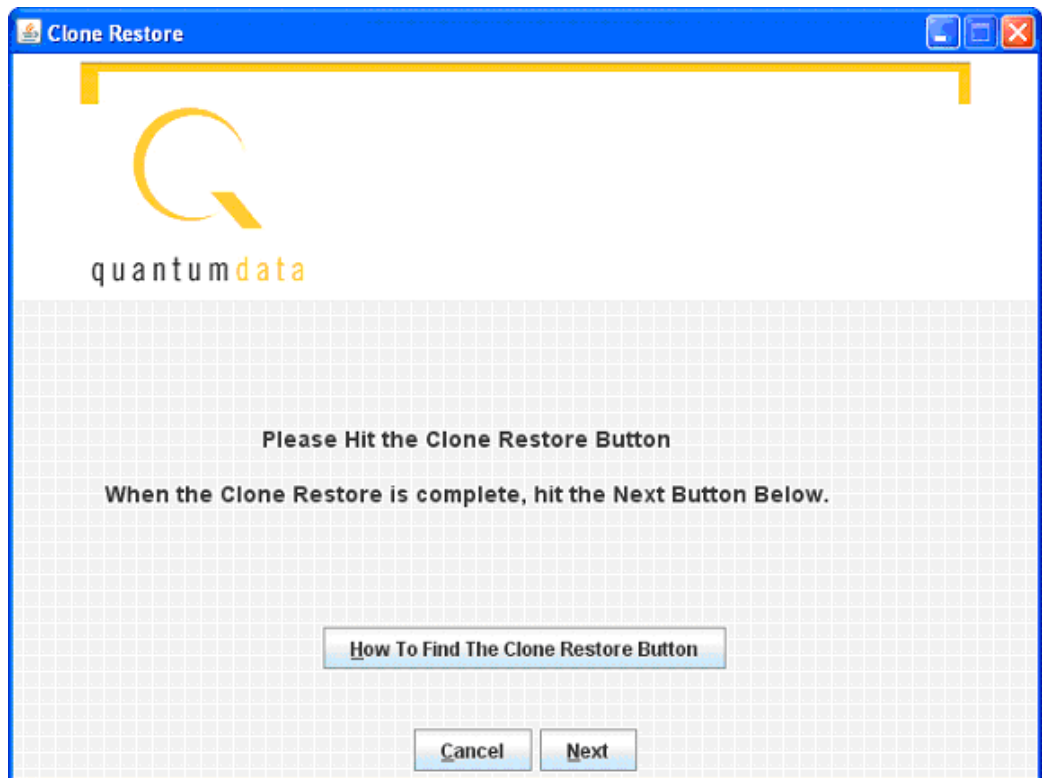

12. After the clone restore is complete, you will again see the menu on the generator's screen. Then click on **Next**.

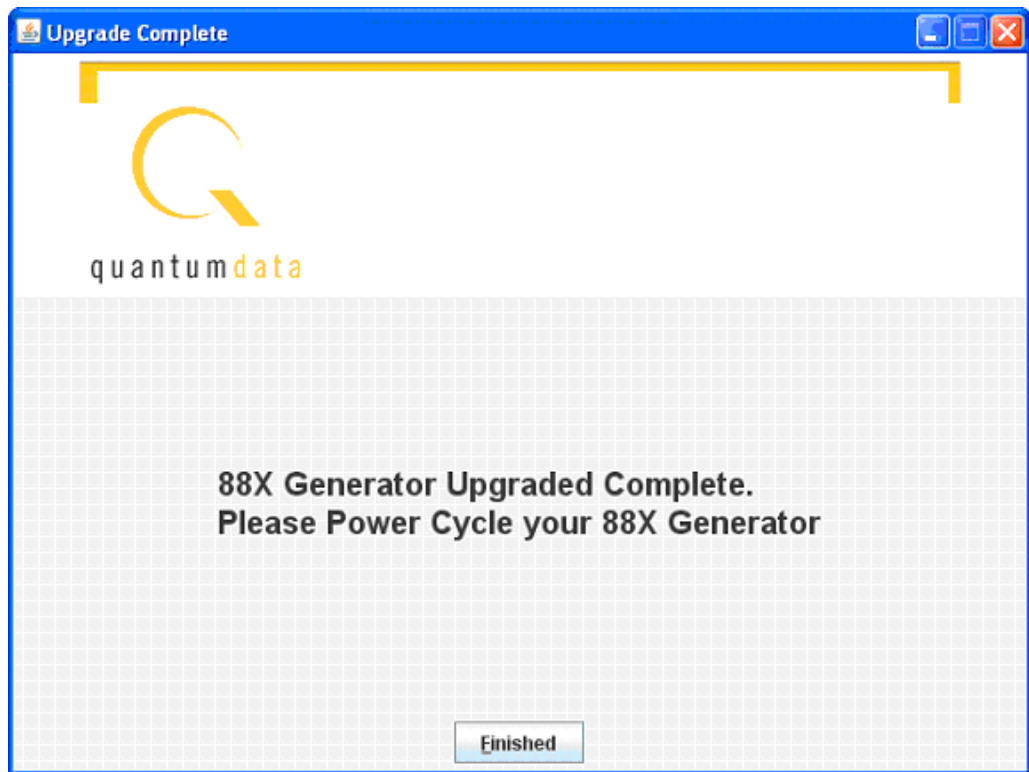

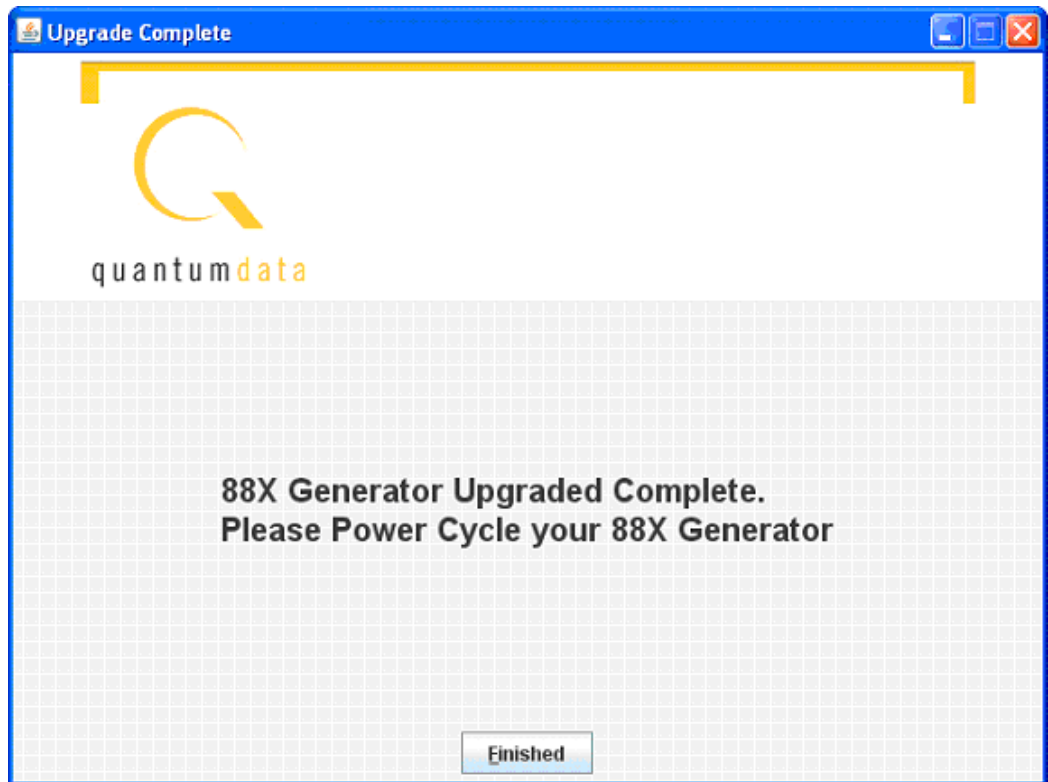

13. Power cycle the generator, and it will boot the upgraded firmware.

Upgrading the generator locally

This section provides procedures for upgrading a generator locally. Procedures for upgrading multiple generators over a network are provided in [“Upgrading 882s over a network”](#) on page 152.

There are two methods for upgrading a generator locally:

- Upgrading using PC card
- Upgrading without using PC card

Upgrading using the PC card is the recommended approach to upgrade the generator locally. However, you may prefer to leave the current files on the PC card so you can return to a known operational state should the upgrade fail. In this case, you can upgrade by transferring the new release files directly to flash memory in the generator.

Manually upgrading using PCMCIA Compact Flash card

This procedure requires that you put the new release files (System and Library directories) on the PC card, then use the Restore function to transfer the files from PCMCIA Compact Flash card (PC Card) to flash memory on the generator.

Important: *If you have custom files stored in flash memory or PC card, you must back them up to your PC before upgrading your generator. These files will be deleted during this upgrade procedure. See [“Copying files from a 882 to a PC”](#) on page 25 for details on using the FTP Browser to back up generator files. Once your generator is upgraded, you will need to restore these files.*

Follow this procedure to upgrade a generator using the PC card.

To upgrade a generator using the PC card:

1. Download the new release zip file from the Quantum Data download page (<http://www.quantumdata.com/downloads/index.asp>) and extract into a folder on your PC.
2. If you have a PCMCIA slot accessible with your PC, perform the following steps. Otherwise, proceed to Step 3.
 - a. Insert the PC card into the PC's PCMCIA slot.
 - b. Transfer the new release files (System and Library directories) to the PC card.
 - c. Remove the PC card from your PC and insert into the generator's PC card slot.

3. If your PC does not have access to a PCMCIA slot or device, use the following procedure. You can skip this step if you performed Step 2 above.
 - a. Access the generator's main web page. For details on this, see ["To connect directly to the generator:"](#) on page 115.
 - b. Access the generator's FTP browser by choosing the **FTP Browser** menu item from the generator's main web page. The Generator FTP Browser appears. The **Instrument Files** area shows the files stored on the generator. The **Host Files** area shows the files stored on the PC.

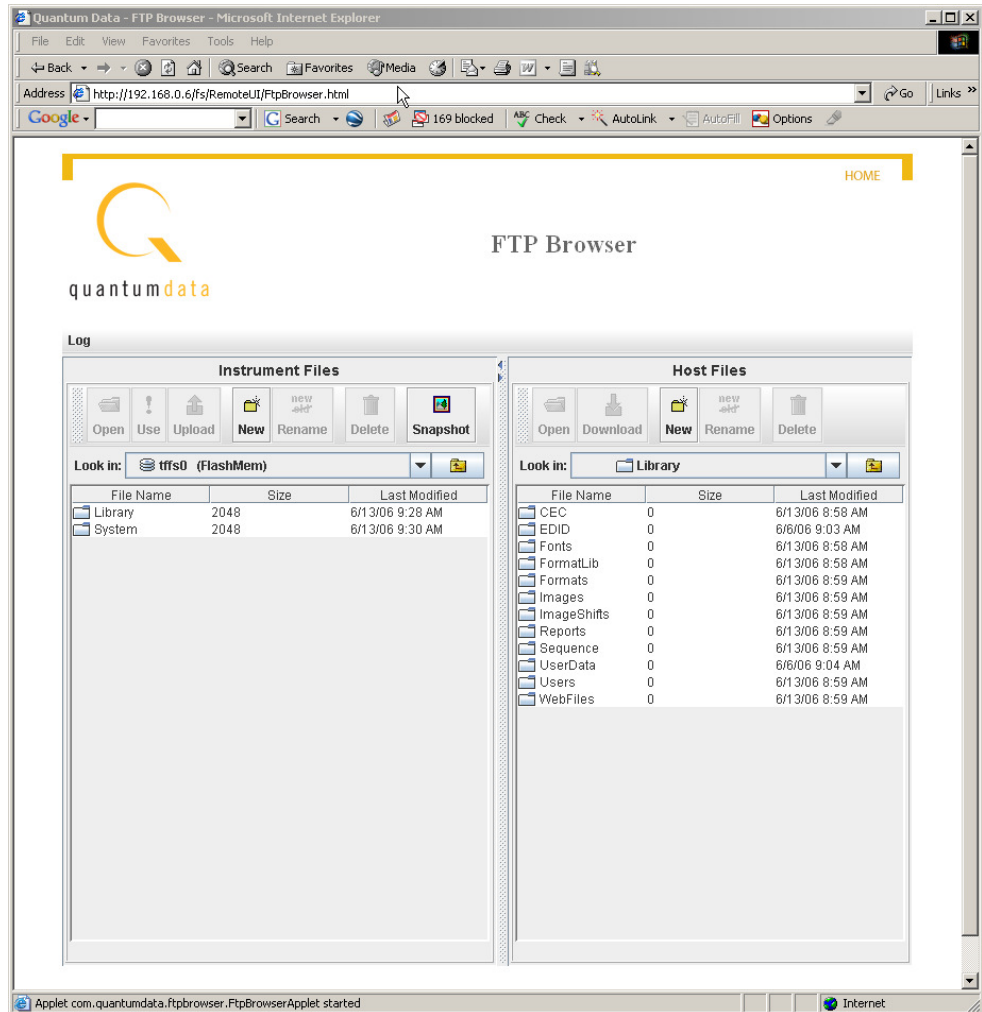

- c. In the **Instrument Files** area, set the destination folder to the PC card. To do this, select **card0** for the generator's PC card.
- d. In the **Instrument Files** area, upload (copy) any custom generator files on the PC card you want to save to a backup folder on the PC.
- e. In the **Instrument Files** area, delete all files stored on the PC card.

- f. In the **Host Files** area, locate and select the new release files (System and Library directories) to transfer to the PC card.
 - g. In the **Host Files** area, click **Download**. The **Transfer Files** dialog box appears.
 - h. Verify that the source file or folder and the destination folder are correct, and then click **OK**. The **Copying Files** dialog box appears showing the status of the operation.
 - i. When transfer is complete, click **Done**.
4. On the generator front panel, press the **Tools** key. The Tools menu appears on the generator's display as shown below.

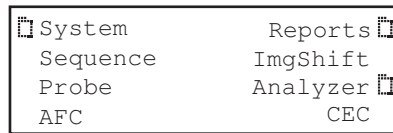

5. Choose the **System** item by pressing the adjacent soft key. The System menu appears on the generator's display as shown below.



6. Choose the **Clone** item by pressing the adjacent soft key. The Clone menu appears on the generator's display as shown below.

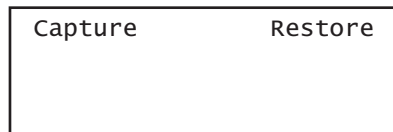

7. Choose the **Restore** item by pressing the adjacent soft key. The current files on the generator's flash memory are replaced by the new release files from the PC card. You are prompted to confirm the restore.
8. Choose **Yes** to proceed with the upgrade by pressing the adjacent soft key. When restore operation is complete, the Tools menu is displayed.
9. Restart the generator while booting from flash memory.
10. Restore any custom files to flash memory or PC card.

Manually upgrading the generator without using PC Card

This procedure allows you to transfer (copy) the new release files (System and Library directories) directly to flash memory without using a PC Card.

Follow this procedure to upgrade a generator without using a PC Card.

1. Download the new release zip file from the Quantum Data download page (<http://www.quantumdata.com/downloads/index.asp>) and extract into a folder on your PC.
2. Access the generator's main web page. For details on this, see "To connect directly to the generator:" on page 115.
3. Access the generator's FTP browser by choosing the **FTP Browser** menu item from the generator's main web page. The Generator FTP Browser appears. The **Instrument Files** area shows the files stored on the generator. The **Host Files** area shows the files stored on the PC.

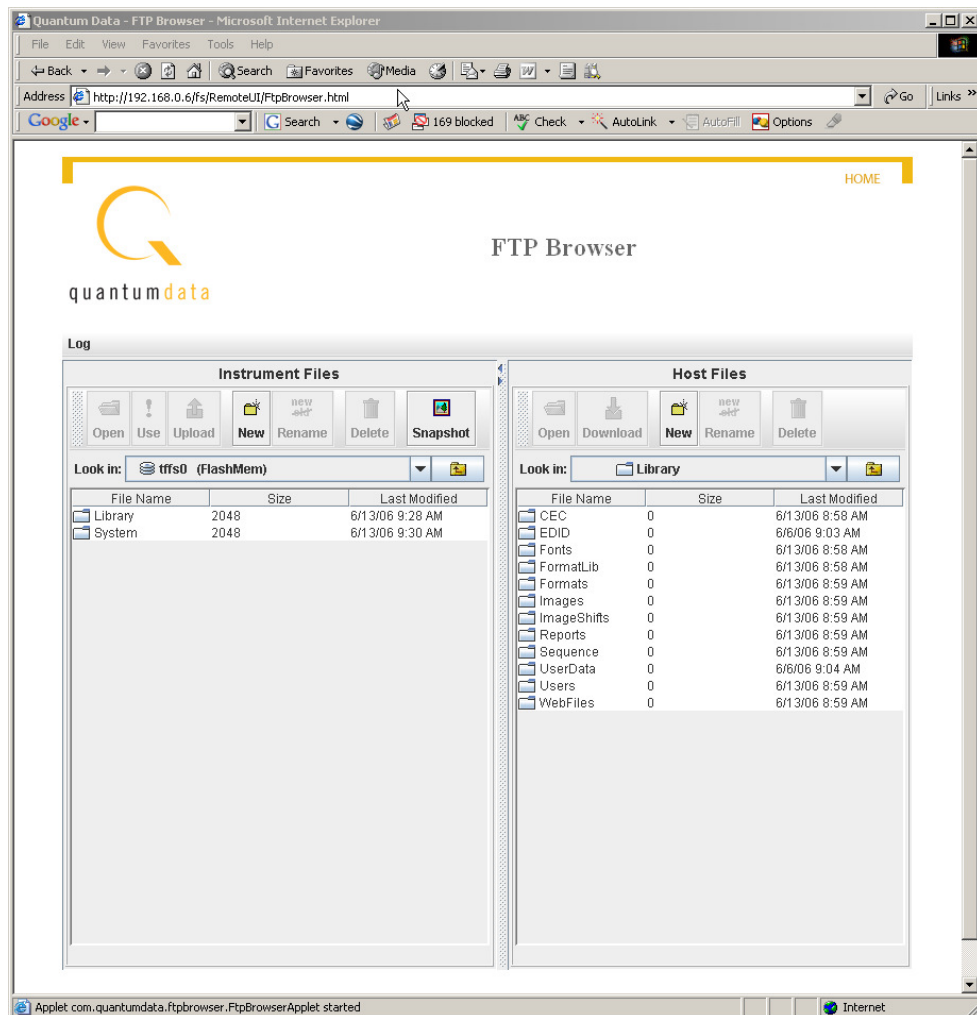

4. In the **Host Files** area, create a backup folder.
5. In the **Host Files** area, open the backup folder.
6. In the **Instrument Files** area, click the down arrow by the **Look in** box and select **tffs0**. This is the generator's flash memory.

7. In the **Instrument Files** area, select all of the folders (or only the specific files in the lower pane that you want to backup).
8. Click **Upload**. A **Transfer Files** dialog box appears.
9. Verify that the source file or folder and the destination folder are correct, and then click **OK**. The **Copying Files** dialog box appears showing the status of the operation.
10. When transfer is complete, click **Done**.
11. In the **Instrument Files** area, select all of the folders (System and Library) in the lower pane.
12. Click **Delete**. A **Deleting Files** dialog box appears.
13. Verify that the selected folders on the generator's flash memory (**tffs0**) are correct, and then click **OK**. The **Deleting Files** dialog box appears showing the status of the operation.
14. When delete is complete, click **Done**.
15. In the **Host Files** area, locate and select the new release files (System and Library directories).
16. In the **Host Files** area, click **Download**. A **Transfer Files** dialog box appears.
17. Verify that the source file or folder and the destination folder are correct, and then click **OK**. The **Copying Files** dialog box appears showing the status of the operation.
18. When transfer is complete, click **Done**.
19. Restart the generator while booting from flash memory.
20. Restore any custom files to flash memory from backup.

Connecting generator directly to a PC

This section describes how to connect your generator directly to a PC using a crossover cable. For instructions on connecting to an Ethernet LAN, see [“Connecting 882s to the network”](#) on page 142.

Use the procedures below to set the IP addresses in your generator and PC, and connect directly to the generator through an Ethernet crossover cable.

1. [“Setting the generator's IP address”](#)
2. [“Setting the PC's network settings”](#)

Setting the generator's IP address

To establish communication between the PC and the generator, the generator must have an IP address. You can view and set the IP address through the front panel using the following procedures.

To set the generator's IP address:

1. Press the **Tools** key. The Tools menu appears on the generator's display as shown below.

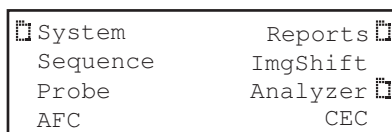

2. Choose the **System** item by pressing the adjacent soft key. The System menu appears on the generator's display as shown below.



3. Choose the **Network** item by pressing the adjacent soft key. The generator's IP address and subnet mask appear on the generator's display as shown below.

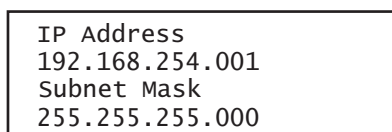

4. Press the **Settings** key. The Network Connection screen appears on the generator's display as shown below.

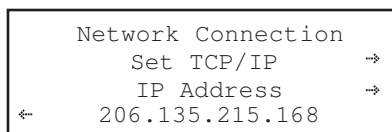

If the IP Address configuration option is not visible, press the soft key adjacent to the arrow symbol by SubnetMask until IP Address appears.

5. Change the IP address as follows:
 - a. Position the blinking cursor on the address digit you want to change. To do this, press the soft key adjacent to the arrow by the address to move the cursor left or right until it appears on the digit you want to change.
 - b. Adjust the value of the digit up or down by pressing the + or - keys. Repeat for each IP address digit you want to change.

6. To save the changes, press the **Enter (Options)** key. The following choices appear on the generator's display:

Apply Settings?	
Yes	Back
	No

To save the changes, choose the **Yes** item by pressing the adjacent soft key.

To exit without saving the changes, choose the **No** item.

To return to the previous screen without saving the changes, choose the **Back** item.

7. Reboot the generator.

Setting the PC's network settings

To establish a local ethernet connection between PC and generator, follow these steps to configure a static IP address on your PC and connect using a crossover cable.

To connect directly to the generator:

1. Determine the IP address of the generator by pressing the **Tools** key, choosing the **System** item, and then choosing the **Network** item. The IP address of the generator appears on the generator's display. Refer to the procedures above "[Setting the 882's IP address](#)" on page 143 for more details on accessing this display.
2. Configure the IP address of your PC. To enter the IP address, open Windows Control Panel, and then open the Network Connections window.
3. In the Network Connections window, right click the connection that represents your Ethernet card and select **Properties**. Select the **Internet Protocol TCP/IP** connection, and then click **Properties**.

Note: If you have more than one Ethernet card make sure you configure the select the correct one.

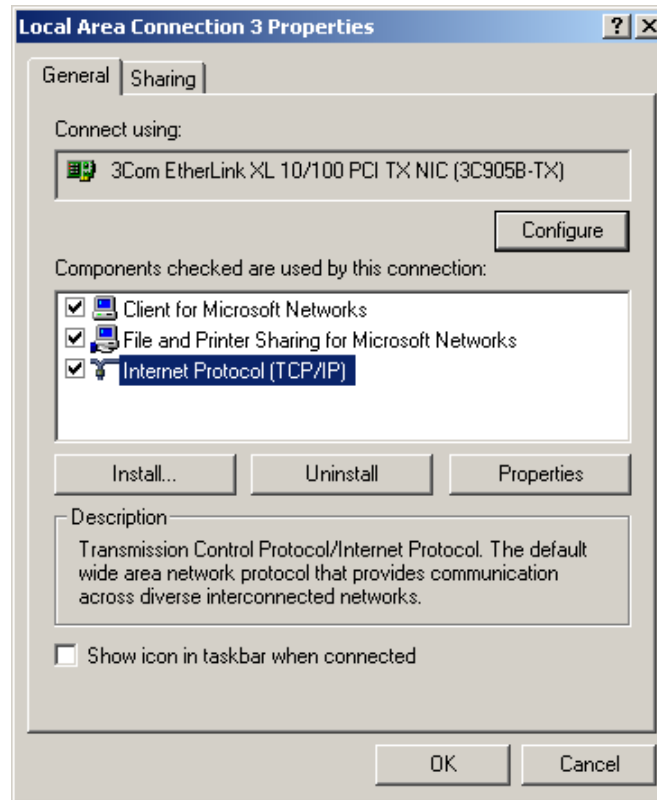

4. In the Internet Protocol (TCP/IP) Properties dialog box, select **Use the following IP address** and type the IP address in the box.

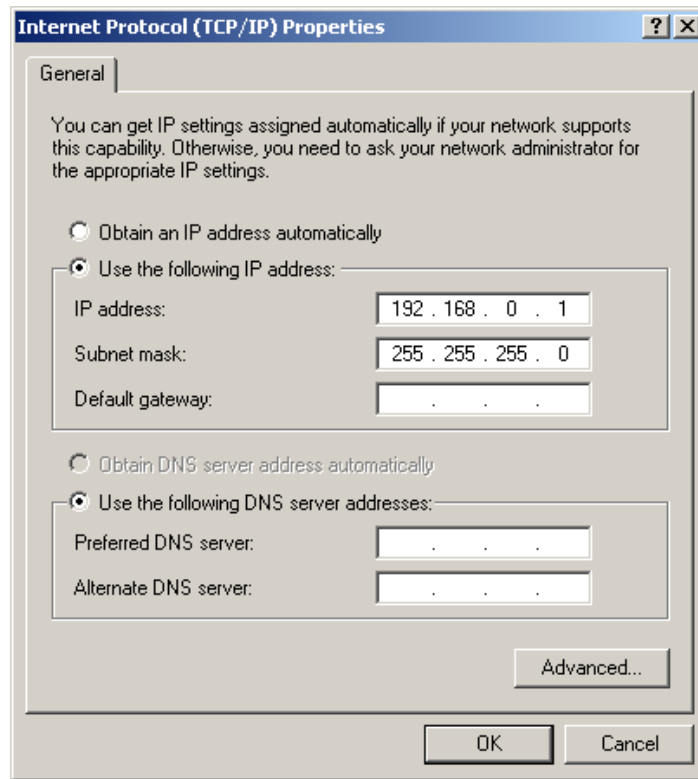

Note: IP addresses consist of a network component and a host component. The network component is represented by the first 3, 6, or 9 digits of the address, depending on the network class. The host component is the last 3 digits. The network component of the IP address you enter for the PC must match the network component of the generator's IP address. The host component of both IP addresses must be different. You do not have to specify the DNS server.

5. Enter the subnet mask such that the network portion of the address is masked to a value of 255 for each.
6. Connect the crossover cable between the ETHERNET jack on the generator and the Ethernet jack on the PC.

7. Open a Web browser (such as Internet Explorer) and type the generator's IP address in the address entry field. For example, enter the following: `http://206.135.215.189/`
The generator web page appears in the browser.



quantum data

HOME

VIRTUAL VIDEO DISPLAY

Click Here

Tools

- Format Editor
- Virtual Front Panel
- FTP Browser
- CMD Terminal
- Auxiliary Channel Analyzer
- EDID Compare Tool
- SAM+
- EDID Editor
- CEC Controller
- Image Control Tool
- Compliance Controller
- Script SDK
- Generated Reports

Reconfiguring and booting a stalled generator

If a generator fails to boot as expected, it may be set to boot from a location with a corrupt system file or without the necessary system files. The symptom of this problem could be that the generator just fails to boot. In other cases you could see an error such as “tffs0 failed to load.” Starting in Release 2.6 (vxWorks file 20.1883600) the generator has a feature which reformats a corrupt file system. Follow the procedures below to boot the generator in these instances.

To boot a generator that is in a stalled state:

1. Apply power to the generator. The following display appears.

```
Quantum Data
windriver
vxWorks System Boot
Press any key for setup
```

To boot from an alternative device, press any key within three seconds. The following display appears. Note that you can also obtain this screen by powering up the generator and holding down any key, e.g. **Tools** key.

```
!BootDev    !Passwd
!HostName   !Flags
!FileName   !Other
!InetAddr   !TrgtName
```

2. Choose the **!BootDev** item by pressing the adjacent soft key.

```
Network Boot
* Internal Flash
PCMCIA Boot
```

3. Do one of the following:
 - To boot from the file server, press the soft key adjacent to **Network Boot**.
 - To boot from the generator’s flash memory, press the soft key adjacent to **Internal Flash**.
 - To boot from the generator’s PC card, press the soft key adjacent to **PCMCIA Boot**.
4. Press the **Options (Enter)** key to save the configuration.
5. Either restart the generator by cycling the power or press the **Tools** key to return to the boot menu.

6. Scroll down to the allow viewing and selection of the BootNow item as shown below.

!FileName	!Other
!InetAddr	!TrgtName
!HostAddr	BootNow
!User	

7. Select **BootNow** by pressing the adjacent item selection key.
8. The following display appears:

Press UP arrow to Boot Now

9. Press the + key to boot the generator.

To boot a generator that has a corrupt file system:

1. Configure a PCard with Release 2.6 (vxWorks file: 20.1883600) or later including all the System and Library files.
2. Insert the PCard in the generator's card slot.
3. Power down the generator, hold down the **Tools** key and then re-apply power to the generator. The following screen appears on the generator's display:

!BootDev	!Passwd
!HostName	!Flags
!FileName	!Other
!InetAddr	!TrgtName

4. Choose the **!BootDev** item, and then choose the **PCMCIA Boot** item from the menu below:

Network Boot
* Internal Flash
PCMCIA Boot

5. Press the **Options (Enter)** key to save the configuration.
6. Either restart the generator by cycling the power or press the **Tools** key to return to the boot menu.
7. Scroll down to the allow viewing and selection of the BootNow item as shown below.

!FileName	!Other
!InetAddr	!TrgtName
!HostAddr	BootNow
!User	

8. Select **BootNow** by pressing the adjacent item selection key.
9. The following display appears:

```

Press UP arrow
to Boot Now
  
```

10. Press the + key to boot the generator.

The following display appears and the generator boots up.

```

Quantum Data
windriver
vxworks System Boot
Press any key for setup
  
```

11. Press the **Tools** key. The Tools menu appears on the generator's display as shown below.

```

[System      Reports
Sequence    ImgShift
Probe       Analyzer
AFC         CEC
  
```

12. Choose the **System** item by pressing the adjacent soft key. The System menu appears on the generator's display as shown below.

```

Clock      Clone*
Ca1Factor  Server
Network    About
Serial     GPib
  
```

13. Choose the **Clone** item by pressing the adjacent soft key. The Clone menu appears on the generator's display as shown below.

```

Capture      Restore
  
```

14. Choose the **Restore** item by pressing the adjacent soft key.

A progress indicator appears. This will take some time.

15. Reconfigure the generator to boot from the Flashmem using the procedures described in ["To boot a generator that is in a stalled state."](#) on page 119.

16. Restart the generator.

17. If the problem persists you may have to unseat the video board from the main board:

<http://www.quantumdata.com/support/videos/video.asp>

18. Repeat the procedure.

To boot a stalled generator from a different host:

1. Power down the generator, hold down the **Tools** key and then re-apply power to the generator. The following screen appears on the generator's display:

```
!BootDev    !Passwd
!HostName   !Flags
!FileName   !Other
!InetAddr   !TrgtName
```

2. Choose the **!BootDev** item, and then choose the **Network Boot** item.
3. Press the **Tools** key and choose the **!HostName** item by pressing the adjacent soft key. The following appears on the generator's display:

```
Boot Line
Setup Boot Host
Hostname
QDEW018 ->
```

4. Change the host name as follows:
 - a. Position the blinking cursor on the character you want to change. To do this, press the soft key adjacent to the arrow by the host name to move the cursor left or right until it appears on the character you want to change.
 - b. Select the desired character by pressing the + or - keys to scroll through uppercase letters, lowercase letters, and numbers. Repeat for each character you want to change.
5. Press the **Options (Enter)** key to save the configuration.
6. Return to the **Tools** menu and choose the **!HostAddr** item by pressing the adjacent soft key. The following appears on the generator's display:

```
Boot Line
Setup TCP_IP
Host IP Address
192.168.254.102 ->
```

7. Change the host IP address as follows:
 - a. Position the blinking cursor on the digit of the IP address you want to change. To do this, press the soft key adjacent to the arrow by the address to move the cursor left or right until it appears on the digit you want to change.
 - b. Adjust the value of the digit up or down by pressing the + or - keys. Repeat for each digit you want to change.
8. Press the **Options (Enter)** key to save the configuration.
9. Restart the generator by cycling the power.

To change the IP address of the generator:

1. From the Boot Menu select **!InetAddr**.

!BootDev	!Passwd
!HostName	!Flags
!FileName	!Other
!InetAddr	!TrgtName

2. Choose the **!InetAddr** by pressing the adjacent item selection key. The generator's IP address and subnet mask appear on the generator's display as shown below.

Network Connection	
Set TCP/IP	→
IP Address	→
←	206.135.215.168

If the IP Address configuration option is not visible, press the soft key adjacent to the arrow symbol by SubnetMask until IP Address appears.

3. Change the host IP address as follows:
 - a. Position the blinking cursor on the digit of the IP address you want to change. To do this, press the soft key adjacent to the arrow by the address to move the cursor left or right until it appears on the digit you want to change.
 - b. Adjust the value of the digit up or down by pressing the + or - keys. Repeat for each digit you want to change.

Cloning generators

You can clone generators using either the generator's PC card or the Generator FTP Browser over an Ethernet connection. To clone a generator, the firmware revision of the source and target generators must match.

Cloning a generator using the PC card

Follow this procedure to clone a generator using the PC card.

To clone a generator using the PC card:

1. Establish a session with the generator using either HyperTerminal over a serial connection or Telnet over an Ethernet LAN. See "[Establishing a terminal session with the 882](#)" on page 30 or "[Establishing a Telnet session with the 882](#)" on page 33.
2. Insert the PC card into the source generator.
3. Press the **Tools** key. The Tools menu appears on the generator's display as shown below.

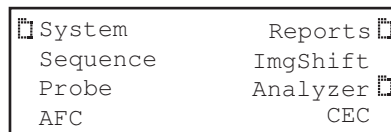

4. Choose the **System** item by pressing the adjacent soft key. The System menu appears on the generator's display as shown below.



5. Choose the **Clone** item by pressing the adjacent soft key. The Clone menu appears on the generator's display as shown below.

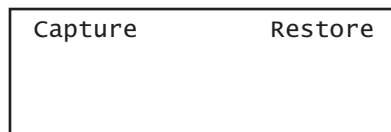

6. Choose the **Capture** item by pressing the adjacent soft key.

Note: The contents on the PC card are replaced by the contents on the flash memory.

A progress indicator appears.

7. Remove the PC card from the source generator and insert it into the target generator.

8. On the target generator, press the **Tools** key. The Tools menu appears on the generator's display as shown below.

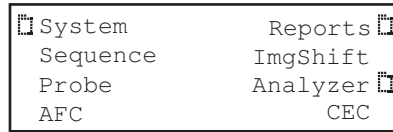

9. Choose the **System** item by pressing the adjacent soft key. The System menu appears on the generator's display as shown below.



10. Choose the **Clone** item by pressing the adjacent soft key. The Clone menu appears on the generator's display as shown below.

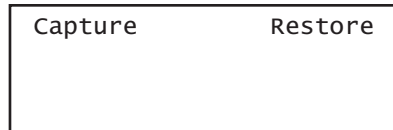

11. Choose the **Restore** item by pressing the adjacent soft key.
A progress indicator appears.
12. Restart the generator from flash memory.

Cloning a generator using the Generator FTP Browser

This section provides procedures for cloning a generator with a PC directly connected to a generator. You will find this cloning method procedure useful if you do not have a PC Card. To complete this procedure you connect the Ethernet crossover cable to the Ethernet ports of both the PC and the generator. If your generators are networked over an Ethernet LAN, see "[Cloning 882s using the 882 FTP Browser](#)" on page 155.

During this procedure, you will copy the files from the source generator to the PC, disconnect the source generator and connect the target generator, and then copy the files from the PC to the target generator. You must know the IP address of both generators.

To clone a generator using the Generator FTP Browser:

1. Connect the source generator to the PC using an Ethernet crossover cable between the Ethernet ports on the PC and the generator.

2. Access the source generator's Generator FTP Browser. See "Working with the 882 FTP Browser" on page 23.

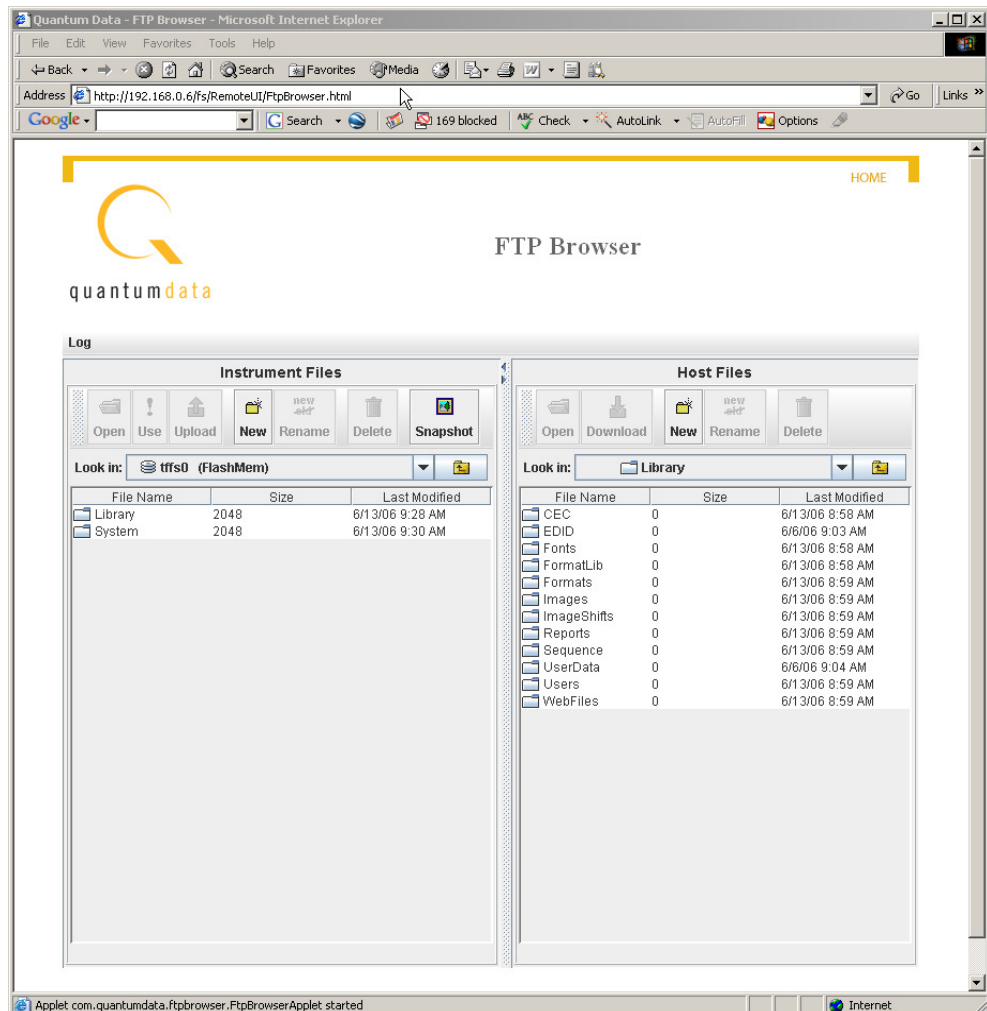

3. Copy all of the files in the source generator's flash memory to the PC as follows:
 - a. In the **Instrument Files** area of the Generator FTP Browser window, click the down arrow by the **Look in** box and select **tffs0 (FlashMem)**.
 - b. Select the system and library folders in the lower pane.
 - c. In the **Host Files** area, open the folder where you want to copy the files. To create a new folder, click **New**.
 - d. In the **Instrument Files** area, click **Upload**. A confirmation dialog box appears.
 - e. Click **OK** to copy the files.
4. Close the Generator FTP Browser.

Note: If both generators on the Ethernet/IP network you do not have to close the source generator FTP Browser.

5. Disconnect the source generator from the Ethernet cable and connect the target generator.

Note: *If both generators on the Ethernet/IP network you do not have to disconnect the generator.*

6. Access the target generator's FTP Browser.
7. Delete the current system and library resource folders from the target generator's flash memory as follows:
 - a. In the **Instrument Files** area, click the down arrow by the **Look in** box and select **tffs0 (FlashMem)**.
 - b. Select all of the files in the lower pane.
 - c. Click the **Delete** button. A confirmation dialog box appears.
 - d. Click **OK** to delete the files.
8. Copy the source system and library folders from the PC to the target generator's flash memory as follows:
 - a. In the **Host Files** area, open the folder containing the system and library folder.
 - b. Select the system and library folders in the lower pane.
 - c. In the **Instrument Files** area, click the down arrow by the **Look in** box and select **tffs0 (FlashMem)**.
 - d. In the **Host Files** area, click **Download**. A confirmation dialog box appears. Click **OK** to download the source files to the generator.
9. Reboot the generator by cycling the power.

Resetting a generator

You can reset a generator to a known good condition.

Note: *Resetting does not restore the generator to factory default condition. Thus, it should not be used to restore proper operation of the generator.*

Follow this procedure to reset a generator.

To reset the generator using the command line interface:

1. Establish a session with the generator using either HyperTerminal over a serial connection or Telnet over an Ethernet LAN. See [“Establishing a terminal session with the 882”](#) on page 30 or [“Establishing a Telnet session with the 882”](#) on page 33.
2. Enter one of the following commands:

- To reset the generator, enter:

```
*RST
```

- To reset and calibrate the generator, enter:

```
*RST          // Resets the generator  
SCAL          // Calibrates the generator
```

Viewing generator configuration information

You can view information about a generator's configuration, including the firmware and gateway revisions, installed options, board serial numbers, and so on. The procedure for accessing this information depends on the type of information you want.

- For information about the main board and video board memory, use the front panel.
- For complete generator statistics, view the GenStats image.
- For firmware and gateway versions, use the command line interface.

This section describes the procedures for accomplishing these methods of accessing generator configuration information.

To view generator configuration information using the front panel:

1. Press the **Tools** key. The Tools menu appears on the generator's display as shown below.

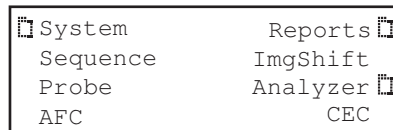

2. Choose the **System** item by pressing the adjacent soft key. The System menu appears on the generator's display.

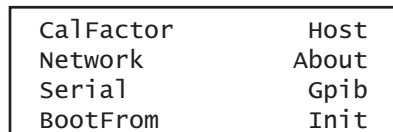

3. Choose the **About** item by pressing the adjacent soft key. A following message appears on the generator's display as shown below.

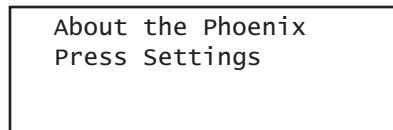

4. Press the **Settings** key. The main board information appears. Press the soft key adjacent to the arrow by Serial Number to see other information about the main board.

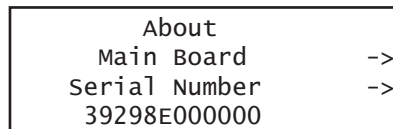

- To view the video board information, pressing the soft key adjacent to the arrow by Main Board. The video board build date appears as shown below. Press the soft key adjacent to the arrow by Build Date to see other information about the video board.

```

      About
<-  Video Board
      Build Date      ->
      2004/08/30

```

To view generator configuration information using the GenStats image:

- Press the **Source** key and select a standard format such as DMT0660.

Alternatively, enter the following commands to load the format:

```
FMTL DMT0660.xml; FMTU
```

- Press the **Content** key and select the GenStats image.

Alternatively, enter the following commands to load the GenStats image:

```
IMGL GenStats.img; IMGU
```

The GenStats image appears as shown below.

```

Generator Information
      Model: 882B
      Unit PN: 0-00164
      Unit Revision: B
      Unit SN: 4100999
      Date: 02032005
      Firmware: 20.1882506
      BootROM: 01.04.11

Memory Status (bytes)
      Free flash: 2838528
      Free RAM: 6297248

Main Board
      Part Num: 99-00505
      Serial Num: 41086
      Board Rev: C

Video Board
      Part Num:
      Serial Num: 0
      Board Rev:
      Date:
      Options: -AN-SDI
      GW 1: 253C,36,1272005
      GW 2: 253F,73,8292005
      GW 3: 253A,5,4252005

Network Setting
      Host Name: QDEW017
      Host Inet: 192.168.254.114
      Unit Inet: 192.168.254.236
      Mask: 255.255.255.0
      MAC Addr: 00:07:AA:00:00:2D

Communications
      Serial: 9600,N,8,1,N,N
      GPIB: 15

Boot Data
      Boot File: /tffs0/system/vxWorks
      Boot Device: tffs0=0,0

Options
      Keypad: Disabled

```

- Establish a session with the generator using either HyperTerminal over a serial connection or Telnet over an Ethernet LAN. See [“Establishing a terminal session with the 882”](#) on page 30 or [“Establishing a Telnet session with the 882”](#) on page 33.

4. Enter the following command to view the generator firmware version (runtime and boot code versions):

```
VERF?  
20.0882002,01.04.11
```

5. Enter the following command to view the generator gateway information for each programmable device:

```
VERG?  
253C,36,1272005:253F,73,8292005:253A,5,4252005
```

The information provided for each gateway is the Product Code, Revision Code and Date Code. There are three sets of gateways listed. The first listing is for an CPLD which does not have an associated file in the System directory. The second listing is for the transmitter and the third listing is for the receiver if the analyzer option is present.

To get a report of the genstats image (or any active image):

1. Press the **Tools** key. The Tools menu appears on the generator's display as shown below.

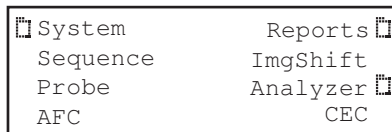

```
System           Reports  
Sequence        ImgShift  
Probe           Analyzer  
AFC             CEC
```

2. Choose the **Reports** item by pressing the adjacent soft key. The Report menu appears on the generator's display.



```
EDID           Packets  
Misc
```

3. Choose the **Misc** item by pressing the adjacent soft key. The following menu appears on the generator's display.

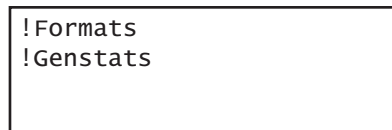

```
!Formats  
!Genstats
```

4. Choose the **!GenStats** item by pressing the adjacent soft key. The generator display will briefly indicate that the report is being generated.

5. Open a Web browser (such as Internet Explorer) and type the generator's IP address in the address entry field. For example, enter the following: `http://206.135.215.189/`
The generator home page appears in the browser.

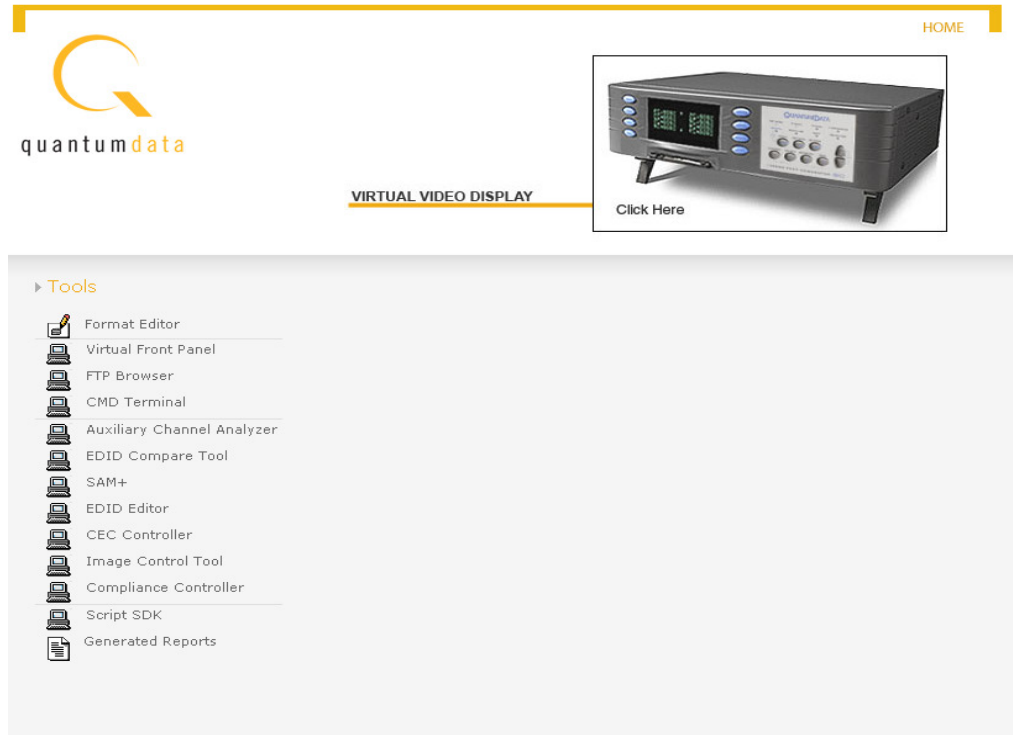

The screenshot shows the Quantum Data web interface. At the top left is the Quantum Data logo. At the top right is a 'HOME' link. In the center, there is a 'VIRTUAL VIDEO DISPLAY' section with a 'Click Here' link and an image of a device. Below this is a 'Tools' menu listing various utilities:

- Format Editor
- Virtual Front Panel
- FTP Browser
- CMD Terminal
- Auxiliary Channel Analyzer
- EDID Compare Tool
- SAM+
- EDID Editor
- CEC Controller
- Image Control Tool
- Compliance Controller
- Script SDK
- Generated Reports

Note: You can add the page to your list of favorite pages in your Web browser to avoid retyping the IP address each time you want to access the page.

6. Choose the **Generated Reports** item. The Generator the provides a list of reports currently available as shown below.

HOME

 Generated Report List

quantumdata

Click on a link to view the report contents

- [Timing Data](#)
- [TX Packets](#)
- [Edid Data](#)
- [Format List](#)
- [GenStats](#)

Jan 18 2007 [01:45:58]

www.quantumdata.com

7. Select the GenStats report. The GenStats report then appears in the browser window as shown below. You can then save the report as an web page file for distribution.

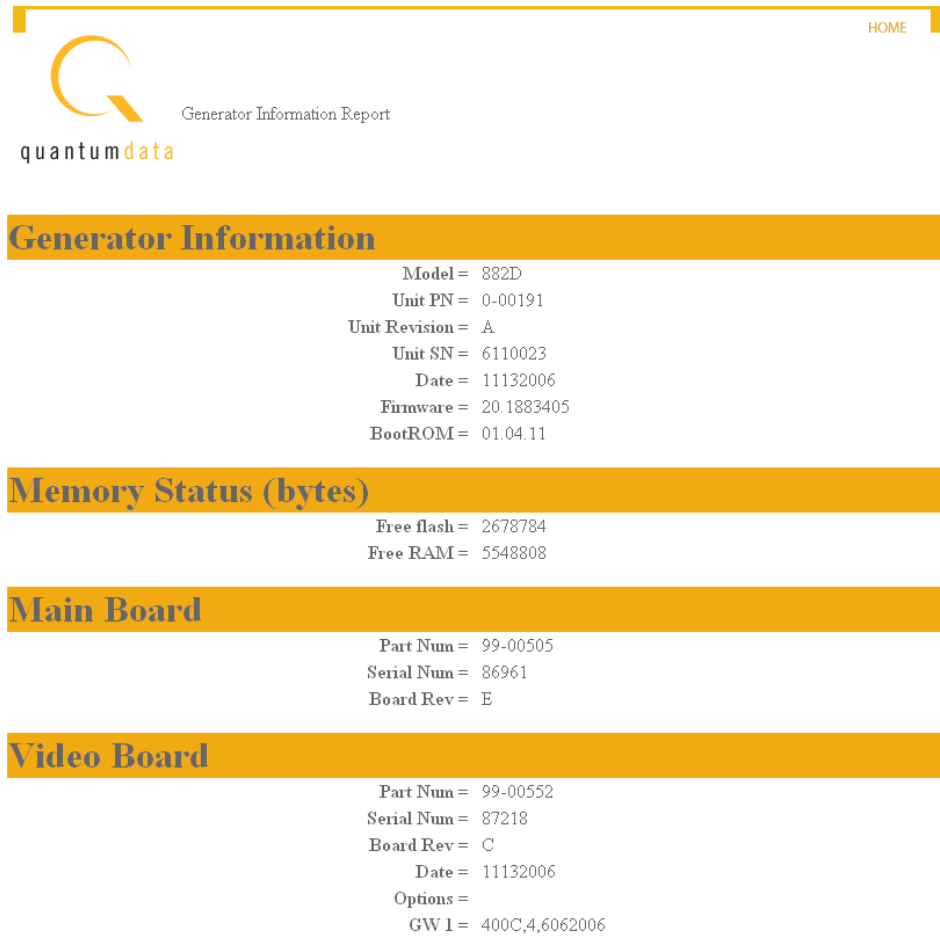

HOME

 Generator Information Report
quantumdata

Generator Information

Model = 882D
Unit PN = 0-00191
Unit Revision = A
Unit SN = 6110023
Date = 11132006
Firmware = 20.1883405
BootROM = 01.04.11

Memory Status (bytes)

Free flash = 2678784
Free RAM = 5548808

Main Board

Part Num = 99-00505
Serial Num = 86961
Board Rev = E

Video Board

Part Num = 99-00552
Serial Num = 87218
Board Rev = C
Date = 11132006
Options =
GW 1 = 400C,4,6062006

4 Networking 882s

Topics in this chapter:

- [Overview](#)
- [Configuring a file server](#)
- [Establishing a network environment](#)
- [Network operations](#)
- [Controlling a 882 remotely](#)
- [Upgrading 882s over a network](#)
- [Cloning 882s using the 882 FTP Browser](#)

Overview

This chapter describes how to use the 882 in a networked environment.

Quantum 882 generators can operate and be administered over an Ethernet LAN connection. By networking multiple 882s together, you can centralize control in production environments.

When networking 882s, a file server containing a set of system and resource files is installed on the network. This arrangement allows you to:

- Set up 882s to automatically retrieve and use a centrally-stored set of system and firmware files upon startup. This ensures that each 882 on the network is running the same firmware.
- Set up 882s to access a common set of objects, such as images and formats, from a file server. This allows each 882 on the network to access the same set of standard and custom library files.
- Easily upgrade a 882's local system and library files from the file server. This ensures that each 882 on the network is using the most current system and library files when booting and accessing files locally.
- Control and maintain your network of 882s remotely from a single host PC. You can manage the 882s through the command line interface, through the Virtual Front Panel in a Web browser, or by transferring files using the 882 FTP Browser.

882 file system

The 882 generator file system is comprised of two main directories (folders): 1) System and 2) Library. The System folder contains the realtime operating system and firmware file (vxWorks) and the gateway. The Library folder contains the following resource files:

- Fonts - Object files used to define the font types.
- Formats - XML files defining the format parameter settings.
- FormatLib - XML files for configuring the source list of formats
- Images - C++ object files, executables, bitmaps, and XML files for rendering images.
- ImageLib - XML files for configuring the content list of images
- Sequences - XML files with instructions for test sequences.
- Users - XML files for user configuration profiles

Configuring a file server

This section describes how to set up a file server. The file server is a PC used to host the 882 system and resource files to be shared by networked 882s. To configure the file server, you must install FTP server software on it, create an FTP directory (site), and copy the 882 system and resource files into the FTP directory.

File server specifications

The minimum configuration for the file server should be as follows:

- Windows NT, Windows 2000, or Windows XP operating system
- Pentium-based processor (for example, Pentium 4)
- 256 MB SDRAM
- 20 MB of free disk space

Note: *If you will be using the Software Development Kit and gcc compiler to create custom images, an additional 100 MB of free disk space is required.*

- Ethernet card and a connection to the corporate LAN
- CD-ROM drive (for loading the 882 system and resource files and documentation from the ResourceCD)
- Java Runtime Environment 1.5 or later

Installing an FTP server

Setting up an FTP server on the file server is necessary if you want the 882s to boot from the file server or if you want to store files on the server that you can access from the 882 in the Browse mode. Any standard FTP server program, such as Microsoft FTP Server, can be used. Microsoft FTP Server operates with Microsoft Internet Information Services; therefore, both must be installed on the server PC.

To set up the FTP server:

1. Install the FTP server software on the file server PC and create the FTP site directory.

You can use Microsoft Internet Information Services shown below.

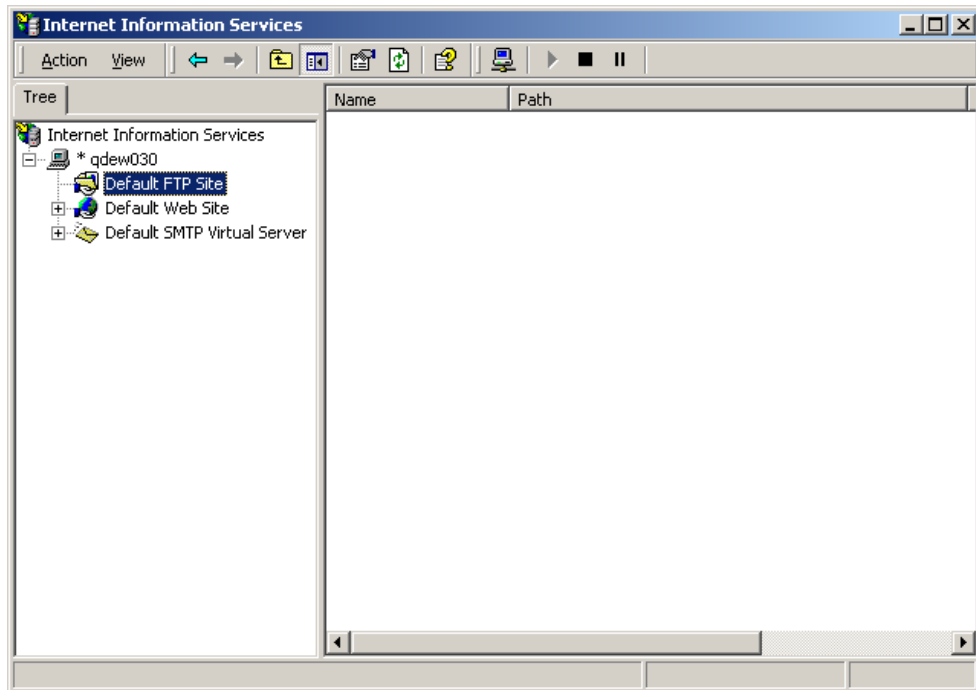

2. Configure the FTP site properties.

- a. On the **Home Directory** tab, enter the name of the **Local Path** (your default directory for the FTP server). By default, Microsoft Internet Information Services

uses C:\inetpub\ftproot as the local path as shown below. You can use this path or click **Browse** to select a different path.

- b. On the **Home Directory** tab, specify read/write access.

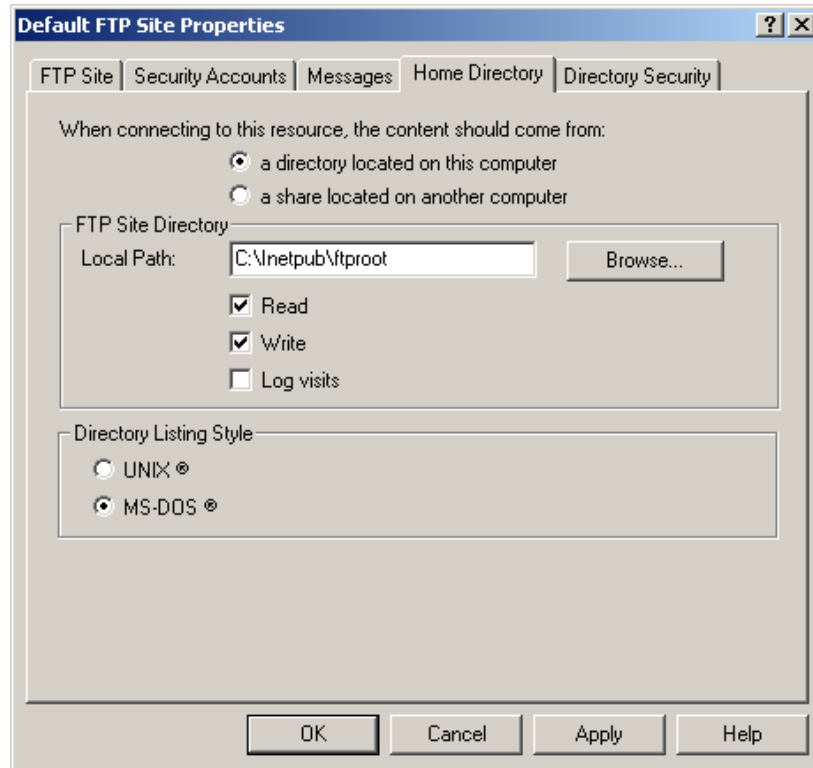

- c. On the **Security Accounts** tab, select **Allow only anonymous connections**, and then click **OK**.

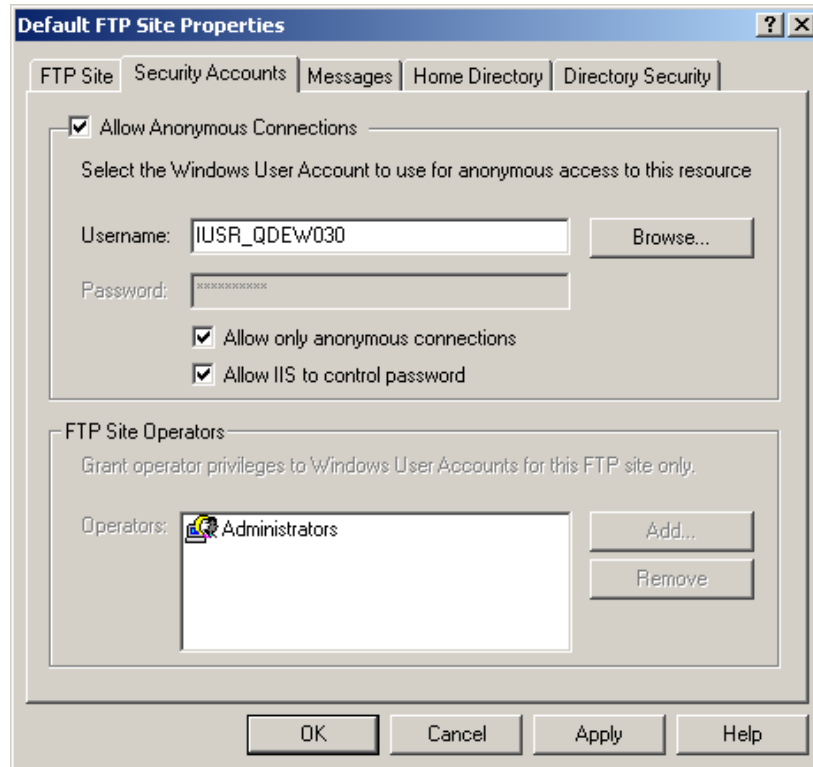

Copying resource files to the FTP site on the file server

After installing the FTP server, you can download the 882 system and resource files from the Quantum Data Web site and copy them to the FTP site on the file server.

To copy 882 system and resource files to the file server:

1. Create a download folder in a convenient location on your PC.
2. Access the download page of the Quantum Data Web site at:
<http://www.quantumdata.com/support/downloads/>
3. Copy the contents of the 882 folder from the download folder to the root folder on the FTP server. The resulting folder structure on the file server PC is shown below.

4. Move the vxWorks file out of the System folder and into the ftproot folder.

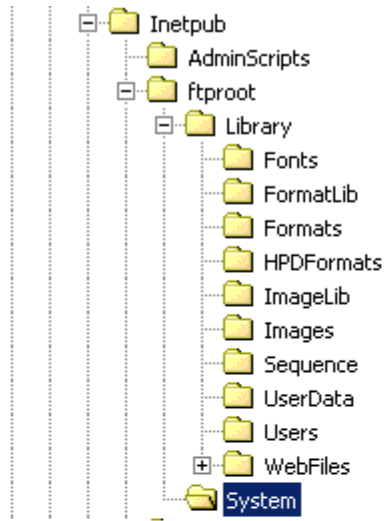

Establishing a network environment

To create a network environment for your 882s, you must physically connect the 882s to the network, and then configure their IP addresses and the IP address of the file server. Procedures for these tasks are described in this section.

Connecting 882s to the network

In a typical networked environment, you will connect the 882s to the corporate, IP-based Ethernet LAN. In this scenario, you connect a standard Ethernet patch cable between the Ethernet port on the 882 and a LAN access jack. The file server is also connected to the LAN in the same manner.

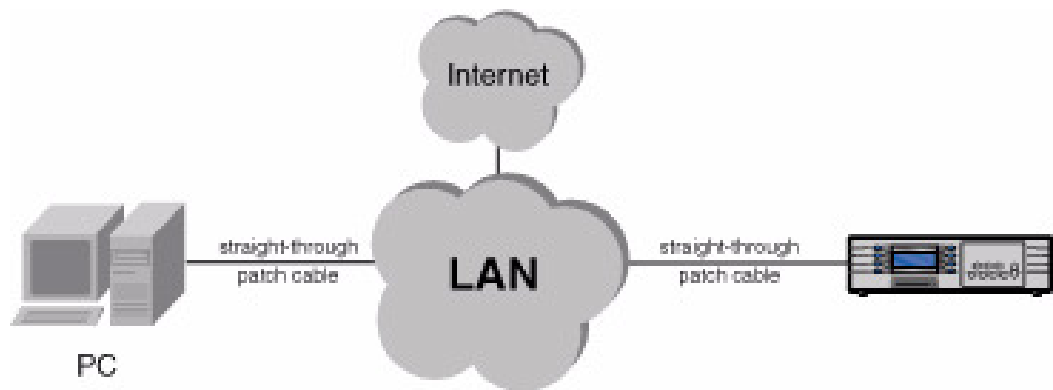

Another type of network scenario is to directly connect a single 882 to a file server. For a direct connection, you must use a crossover Ethernet cable and connect it from the Ethernet port on the file server to the 882 Ethernet port as shown below.

Note: If you are using a PC that is connected to a network that automatically assigns an IP address, and you will be disconnecting from that network to connect to the crossover cable and 882, you must manually enter an IP address into the PC so it can communicate with the 882. The network portions of the IP addresses of the 882 and the PC must match.

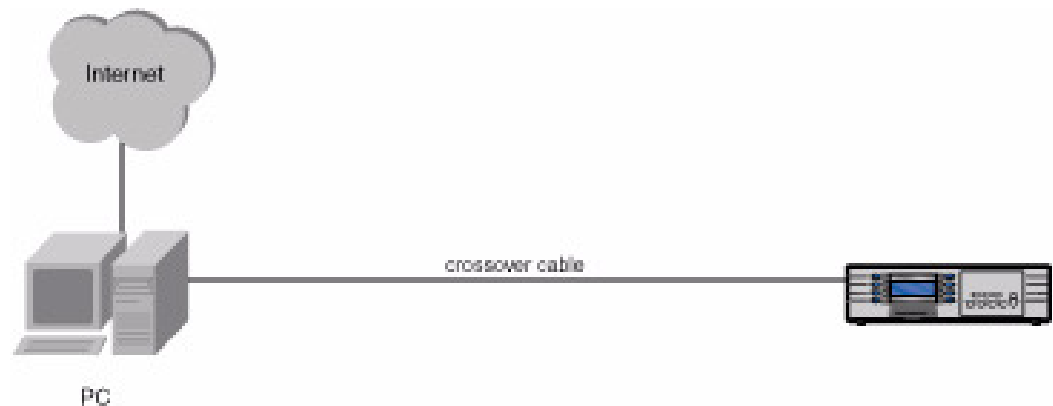

When the network connection on the 882 is active, the **Network** LED lights on the front panel.

Setting the 882's IP address

You can either set the IP address of the 882 manually with an address you select or automatically by using the built in DHCP support. The default state of the 882 is that DHCP is off. So you have to enable it if you want the IP address to be set automatically from a DHCP server. The procedures for setting the IP address manually and enabling DHCP for auto configuration are provided below.

Each 882 on the network must have a unique IP address if you want to control the 882 over a network, or want the 882 to share resources located on a file server. Typically, your site's LAN administrator will provide you with IP addresses for each 882. Depending on how your site's LAN is configured, your LAN administrator may also provide you with a subnet mask.

To set the IP address of the 882:

1. Press the **Tools** key. The Tools menu appears on the 882's display as shown below.

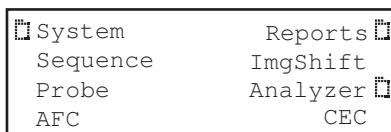

A screenshot of the Tools menu on the 882 display. The menu is displayed in a monospaced font and is organized into two columns. The items are: System, Reports, Sequence, ImgShift, Probe, Analyzer, AFC, and CEC. Each item has a small square icon to its left or right.

System	Reports
Sequence	ImgShift
Probe	Analyzer
AFC	CEC

2. Choose the **System** item by pressing the adjacent soft key. The System menu appears on the 882's display as shown below.

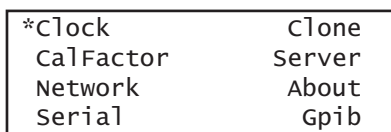

A screenshot of the System menu on the 882 display. The menu is displayed in a monospaced font and is organized into two columns. The items are: *Clock, Clone, CalFactor, Server, Network, About, Serial, and Gpib.

*Clock	Clone
CalFactor	Server
Network	About
Serial	Gpib

3. Choose the **Network** item by pressing the adjacent soft key. The 882's IP address and subnet mask appear on the 882's display as shown below.

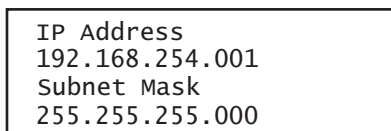

A screenshot of the Network menu on the 882 display. The menu is displayed in a monospaced font and contains four lines of text: IP Address, 192.168.254.001, Subnet Mask, and 255.255.255.000.

IP Address
192.168.254.001
Subnet Mask
255.255.255.000

4. Press the **Settings** key. The Network Connection screen appears on the 882's display as shown below.

```
Network Connection
Set TCP/IP      →
IP Address      →
← 206.135.215.168
```

If the IP Address configuration option is not visible, press the soft key adjacent to the arrow symbol by SubnetMask until IP Address appears.

5. Change the IP address as follows:
 - a. Position the blinking cursor on the address digit you want to change. To do this, press the soft key adjacent to the arrow by the address to move the cursor left or right until it appears on the digit you want to change.
 - b. Adjust the value of the digit up or down by pressing the + or - keys. Repeat for each IP address digit you want to change.
6. If necessary, change the subnet mask as follows:
 - a. If the SubnetMask configuration option is not visible, press the soft key adjacent to the arrow symbol by IP Address until SubnetMask appears.
 - b. Position the blinking cursor on the subnet mask digit you want to change. To do this, press the soft key adjacent to the arrow by the subnet mask to move the cursor left or right until it appears on the digit you want to change.
 - c. Adjust the value of the digit up or down by pressing the + or - keys. Repeat for each subnet mask digit you want to change.

```
Network Connection
Set TCP/IP      →
← SubnetMask
← 000.000.000.000
```

7. To save the changes, press the **Enter (Options)** key. The following choices appear on the 882's display:

```
Apply Settings?
Back
Yes              No
```

To save the changes, choose the **Yes** item by pressing the adjacent soft key.

To exit without saving the changes, choose the **No** item.

To return to the Network Connection screen without saving the changes, choose the **Back** item.

8. Power cycle the 882 to invoke the new IP address.

To enable DHCP for auto IP address configuration of the 882:

1. Press the **Tools** key. The Tools menu appears on the 882's display as shown below.

```
System      Reports
Sequence   ImgShift
Probe       Analyzer
AFC         CEC
```

2. Choose the **System** item by pressing the adjacent soft key. The System menu appears on the 882's display as shown below.

```
*Clock      Clone
CalFactor   Server
Network     About
Serial      Gpib
```

3. Choose the **Network** item by pressing the adjacent soft key. The 882's IP address and subnet mask appear on the 882's display as shown below.

```
IP Address
192.168.254.001
Subnet Mask
255.255.255.000
```

4. Press the **Settings** key. The Network Connection screen appears on the 882's display as shown below.

```
Network Connection
Set TCP/IP    ->
IP Address    ->
<- 206.135.215.168
```

If the DHCP configuration option is not visible, press the soft key adjacent to the arrow symbol by SubnetMask or IP Address until the DHCP configuration screen appears.

```
Network Connection
TCP/IP
<- DHCP Enabled
NO
```

5. Change the setting to YES by pressing the + key.

```
Network Connection
TCP/IP
<- DHCP Enabled
YES
```

- To save the changes, press the **Enter (Options)** key. The following choices appear on the 882's display:

```
Apply Settings?
                                     Back
Yes                                     No
```

To save the changes, choose the **Yes** item by pressing the adjacent soft key.

To exit without saving the changes, choose the **No** item.

To return to the Network Connection screen without saving the changes, choose the **Back** item.

- Power cycle the 882 to set the IP address of the 882.

Setting the file server IP address in the 882

You must enter the IP address of the file server in each 882 so the 882 can communicate with the file server. In addition, you can also enter a name (called the Host Name) for the file server.

To specify the IP address and host name of the file server:

- Press the **Tools** key. The Tools menu appears on the 882's display as shown below.

```
System      Reports
Sequence    ImgShift
Probe       Analyzer
AFC         CEC
```

- Choose the **System** item by pressing the adjacent soft key. The System menu appears on the 882's display as shown below.

```
*Clock      Clone
CalFactor   Server
Network     About
Serial      Gpib
```

- Choose the **Server** item by pressing the adjacent soft key. The server name and IP address appear on the 882's display.

```
Host IP Address
Host001
206.135.215.218
```

4. Press the **Settings** key. The Network Host screen appears on the 882's display as shown below.

```
Network Host
Set Boot Host
Host Address  →
← 206.135.215.218
```

If the Host Address configuration option is not visible, press the soft key adjacent to the arrow symbol by Host Name until Host Address appears.

5. Change the host address as follows:
 - a. Position the blinking cursor on the address digit you want to change. To do this, press the soft key adjacent to the arrow by the address to move the cursor left or right until it appears on the digit you want to change.
 - b. Adjust the value of the digit up or down by pressing the + or - keys. Repeat for each address digit you want to change.
6. (Optional) Change the host name as follows:
 - a. If the Host Name configuration option is not visible, press the soft key adjacent to the arrow symbol by Host Address until Host Name appears.
 - b. Position the blinking cursor on the character you want to change. To do this, press the soft key adjacent to the arrow by the name to move the cursor left or right until it appears on the character you want to change.
 - c. Select the desired character by pressing the + or - keys to scroll through uppercase letters, lowercase letters, and numbers. Repeat for each character you want to change.

```
Network Host
Set Boot Host
← Host Name
← Host001
```

7. To save the changes, press the **Enter (Options)** key. The following choices appear on the 882's display:

```
Apply Settings?
Back
Yes No
```

To save the changes, choose the **Yes** item by pressing the adjacent soft key.

To exit without saving the changes, choose the **No** item.

To return to the Network Host screen without saving the changes, choose the **Back** item.

8. Power cycle the 882 to set the server IP address.

Network operations

This section provides common networking tasks, such as booting 882s from the file server, accessing files stored on the file server, transferring files from the file server to the 882, and controlling the 882 remotely.

Booting a 882 from the file server

A 882 can be set up to boot from an operating system (vxWorks) file stored on the file server. To do this, you must set the IP address of the file server in the 882, and then configure the 882 to use the file server as a boot device. For instructions on setting the IP address of the file server in the 882, see [“To enable DHCP for auto IP address configuration of the 882:”](#) on page 145.

Procedures for booting the 882 from the file server are provided below. For procedures to boot a stalled 882 refer to [“Reconfiguring and booting a stalled generator”](#) on page 119.

To configure the 882 to boot from the file server:

1. Copy the vxWorks folder into the ftproot folder using the procedures described in [“Copying resource files to the FTP site on the file server”](#) on page 140.
2. Press the **Tools** key. The Tools menu appears on the 882’s display as shown below.

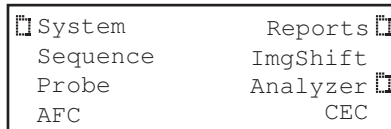

3. Choose the **System** item by pressing the adjacent soft key. The System menu appears on the 882’s display as shown below.
4. Scroll down to the end of the System menu by pressing the - key until the following menu items appear on the 882’s display:

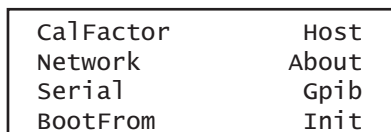

5. Choose the **BootFrom** item by pressing the adjacent soft key. The BootFrom menu appears on the 882’s display as shown below.

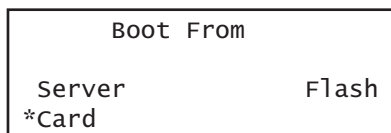

6. Choose the **NetPlace** item by pressing the adjacent soft key.

Sharing objects on a file server

The 882 can be set up to access shared format, image, and sequence files stored on a file server. To do this, you must set the 882's path to point to the corresponding folders on the file server. You can set the path using the command line interface or the front panel.

To set the 882's path using the command line interface:

1. Establish a session with the 882 using either HyperTerminal over a serial connection or Telnet over an Ethernet LAN. See “[Establishing a terminal session with the 882](#)” on page 30 or “[Establishing a Telnet session with the 882](#)” on page 33.
2. For each file type (format, image, and sequence), set the path parameter to the corresponding folder on the file server using the following commands:

```
FMTM hostname:/Library/Formats
IMGP hostname:/Library/Images
SEQP hostname:/Library/Sequences
```

For example if your file server host name is Host01, you would enter the following command to set the format path to the Formats directory on the file server:

```
FMTM Host01:/Library/Formats
```

Note: *The hostname portion of the path is case sensitive.*

The 882 will now display the formats on the file server when you press the **Source** key.

To set the 882's path using the front panel:

1. Place the 882 in Browse mode by holding down the **Tools** key until the media menu appears on the 882's display as shown below.

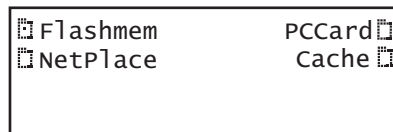

2. Choose the **NetPlace** item by pressing the adjacent soft key. The folders on the file server appear on the 882's display as shown below.

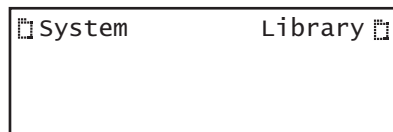

3. Choose the **Library** item by pressing the adjacent soft key. A list of folders in the library folder appear on the 882's display as shown below.

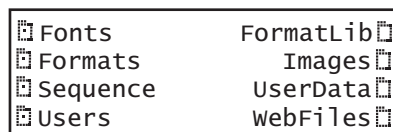

4. Press the soft key adjacent to the folder you want to use. For example, to use the Formats folder, press the soft key adjacent to Formats. The contents of the selected folder appears on the 882's display.
5. Choose an item by pressing the adjacent soft key. The path is now set to the selected folder on the file server.

Controlling a 882 remotely

In addition to controlling the 882 using the front panel keys, you can also control the 882 from a remote PC either through the Virtual Front Panel Web-based interface or the command line interface.

Using the Virtual Front Panel to operate a 882 remotely

The 882 generator has a built-in Web server that provides a graphical interface called the Virtual Front Panel to control the 882. With the Virtual Front Panel, you can perform the same tasks as you would with the 882's front panel. To use the Virtual Front Panel on your PC you must have the Java Runtime Environment (JRE) 1.5 or later installed on your PC. You can download the JRE from http://www.java.com/en/download/windows_ie.jsp. For more information about using the Virtual Front Panel, see “[Working with the Virtual Front Panel](#)” on page 20.

Maintaining the 882's file system using the 882 FTP Browser

If you create objects on a PC, such as images or formats, you can copy these objects to a 882 if you want the 882 to load them locally. For example, you may want to create a new image on the file server PC, and then copy the image to certain 882s in your production environment. The 882 FTP Browser enables you to copy files between the file server PC and the 882s.

You can also use the 882 FTP Browser to copy files between media in the 882. For example, you can update the 882's PC card with the 882's flash memory or update the flash memory with files on the PC card. You can also update the media of one 882 with the contents of another 882's media.

For more information about using the 882 FTP Browser, see “[Working with the 882 FTP Browser](#)” on page 23.

Operating the 882 remotely through the command line interface

You can operate the 882 remotely using the command line interface through either a Telnet session over an Ethernet LAN or the command terminal on the Virtual Front Panel Web page. For instructions on connecting to the 882 using Telnet, see “[Establishing a Telnet session with the 882](#)” on page 33. For instructions on using the command terminal through the Virtual Front Panel, see “[Working with the CMD \(Command\) Terminal](#)” on page 22.

Upgrading 882s over a network

An upgrade to a network of 882s can involve a new system and firmware file (“vxWorks”), a new gateway file, and new library resource files. In some cases you may be upgrading only the firmware or only the gateway, but not both. In other cases, the upgrade may involve only new images or formats. The procedures you follow for an upgrade will therefore depend on what you are upgrading.

This section provides procedures for upgrading 882s over a LAN. The procedures for upgrading a single 882 that is not connected to a LAN are provided in [“Upgrading the generator locally”](#) on page 109.

Upgrade options and procedures

The recommended procedure for upgrading is to upgrade the file server and the flash memory of each 882. Upgrading the PC card is optional, depending on how your site uses the PC card. For example, you may decide to leave the current files on the PC card so you can return to a known operational state should the upgrade fail.

To begin an upgrade, you must either have a CD-ROM containing the new files, or download the files from the Quantum Data Web site. You will copy the new files to your file server PC which must be connected to the LAN through the Ethernet cable.

Overview of upgrade procedures

The following are the high-level steps for performing a complete upgrade (system and firmware file, gateway, and library resource files) to 882s over a network. Detailed instructions for each step are provided in the sections that follow.

1. Back up the current file server system and firmware file, gateway, and library files.
2. Copy the new 882 system and firmware file, gateway, and resource files onto the file server PC.
3. Remove the system and firmware file, gateway, and library resource files from each 882’s flash memory.
4. Copy the new system and firmware file, gateway, and library resource files from the file server PC to each 882’s flash memory.
5. Reboot all 882s.

Backing up the current files on the file server

Backing up the current files ensures that you can return to a known operational state should the upgrade fail.

To back up the current files on the file server:

1. Create a separate, backup folder on your file server PC (not in the FTP folder) to house the files currently used by the network of 882s.
2. Open the FTP site folder and copy the contents of the folder to your backup folder. These should include the 882 directory and the System and Library folders as shown below.

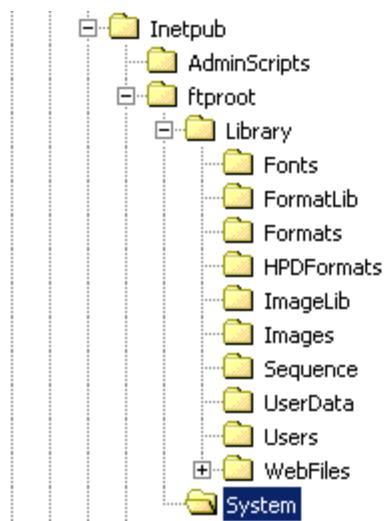

3. If any of the 882s have custom format, image, sequence, or font files that do not also reside on the file server, you must back them up to the backup folder on the file server independently to preserve them. See [“Backing up the current files on the file server”](#) on page 152 for instructions.

You might want to back up only the custom files on the 882 to a custom folder on the file server you create. Alternatively if you are sure you want to restore a 882 with its current set of library files you can simply backup its entire library folder to a custom folder on the file server.

Copying files to the PC file server

After you have backed up your existing files, you must delete the current files from the FTP folder on the file server, and then copy the new, updated files to the FTP folder. Before you begin, you must either have a CD-ROM containing the new system, gateway, and library files, or download the files from the Quantum Data Web site.

To copy the new files to the file server:

1. Open the FTP site folder and delete the contents.
2. Open the 882 folder from the location where you downloaded the files from the Quantum Data Web site.

3. Copy the contents of the 882 folder to the FTP site folder. The resulting folder structure is shown below.

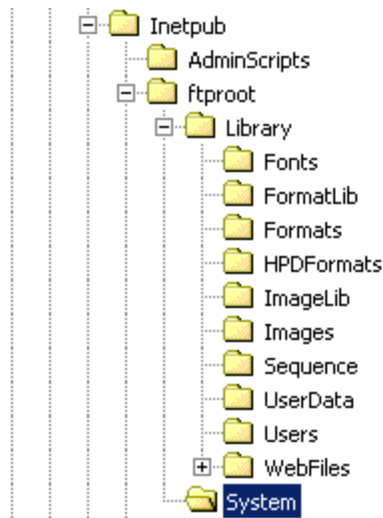

Removing current files from the 882s

Prior to upgrading the 882s, you must remove the existing system and firmware file, gateway, and resource files from the flash memory of each 882. For instructions on removing files from the 882, see [“Upgrading the generator locally”](#) on page 109. If you are also installing the new files on the 882’s PC card, you must also remove the current files from the PC card.

Copying the new files to each 882

Now you are ready to copy the new, updated system and firmware, gateway, and library resource files to the 882s to complete the upgrade. See [“Working with the 882 FTP Browser”](#) on page 23 for instructions.

Reboot the 882s

The upgrade is now complete and you are ready to reboot the 882s from the updated system files you just copied to each 882’s flash memory. Reboot each 882 by cycling the power.

Cloning 882s using the 882 FTP Browser

You can clone 882s either through the front panel or through the 882 FTP Browser on the Virtual Front Panel Web page. Procedures for cloning 882s through the front panel are provided in “[Cloning generators](#)” on page 124.

This section describes how to clone 882s by copying system and library files over the network using the 882 FTP Browser.

To clone a 882:

1. Access the 882’s FTP browser by choosing the **FTP Browser** menu item from the main web page. The 882 FTP Browser appears. The Instrument Files area shows the files stored on the 882. The Host Files area shows the files stored on the PC.

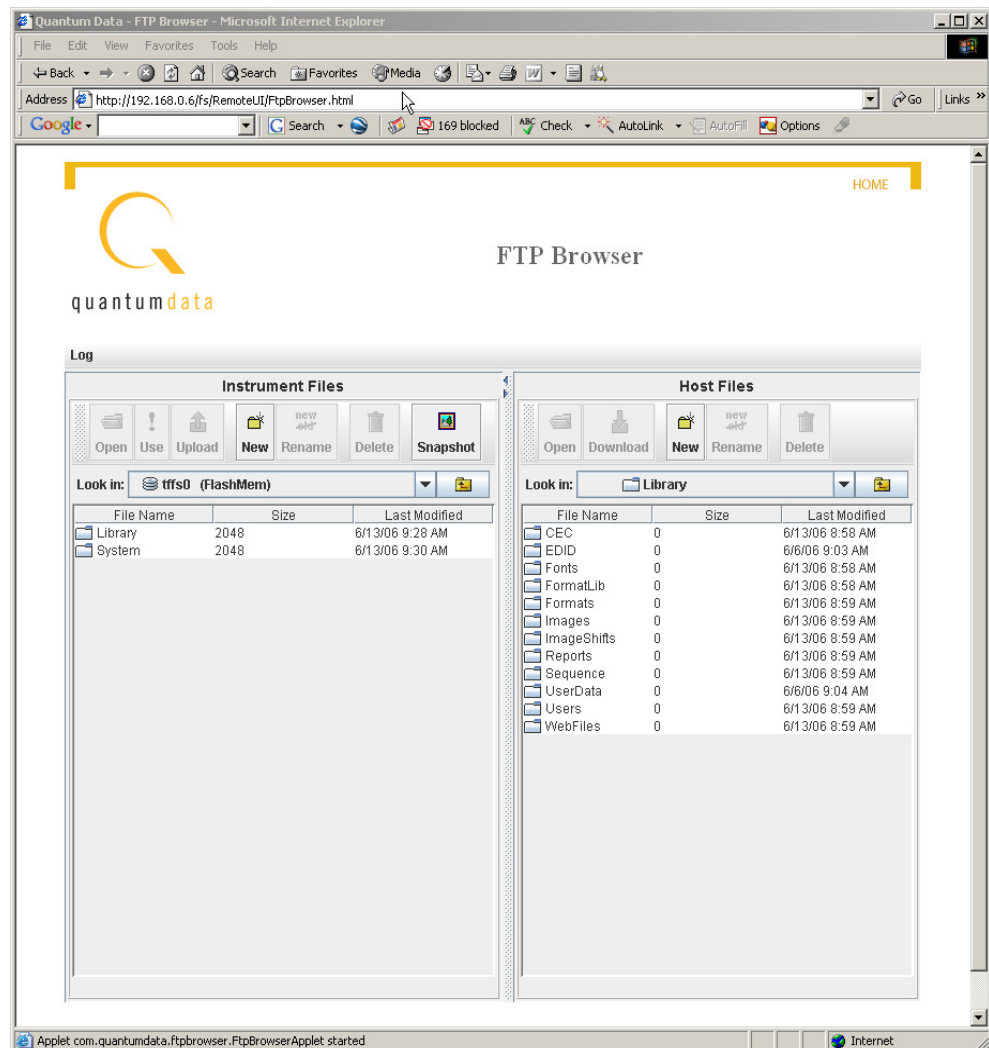

2. Open a second Web browser. You now have two instances of the 882 FTP Browser running: one for the source 882 and one for the target 882.

3. In the 882 FTP Browser window for the target 882, delete all of the files in the target 882's flash memory as follows:
 - a. In the **Instrument Files** area, click the down arrow by the **Look in** box and select **tffs0**. This is the target 882's flash memory.
 - b. Select all of the System and Library folders in the lower pane.
 - c. Click the **Delete** button. A confirmation dialog box appears.
 - d. Click **OK** to delete the files.
4. Copy all of the files in the source 882's flash memory to the target 882's flash memory as follows:
 - a. In the **Instrument Files** area of source 882's 882 FTP Browser window, click the down arrow by the **Look in** box and select **tffs0**. This is the source 882's flash memory.
 - b. Select the System and Library folders in the lower pane.
 - c. Hold down the SHIFT key and drag the selected folders to the **Instrument Files** area of the target 882's FTP Browser window. A confirmation dialog box appears.
 - d. Click **OK** to copy the files.

5 Using GPIB Interface

Topics in this chapter:

- [Overview](#)
- [Setting the GPIB port address](#)
- [Queries and commands](#)
- [Status queries and control](#)

Overview

You can operate and program the generator from an external computer or terminal using the optional IEEE-488 (GPIB) interface. The GPIB interface enables the generator to be used as a programmable video signal source for integration into automated test systems that use IEEE-488 or GPIB communications between instruments.

Setting the GPIB port address

The default GPIB address is 15. You can specify a different address as described in the procedure below.

To set the address of the GPIB port using the front panel:

1. Press the **Tools** key. The Tools menu appears on the generator's display as shown below.

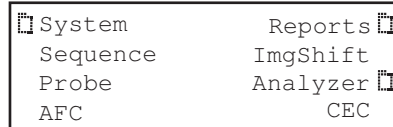

2. Choose the **System** item, and then choose the **GPIB** item. The GPIB address appears on the generator's display as shown below.
3. To change the address, do the following:
 - a. Press the **Settings** key.
 - b. Position the blinking cursor on the address digit you want to change. To do this, press the soft key adjacent to the arrow by the address to move the cursor left or right until it appears on the digit you want to change.
 - c. Adjust the value of the digit up or down by pressing the + or - keys. Repeat for each address digit you want to change.
4. To save the changes, press the **Enter (Options)** key. The following choices appear on the generator's display:

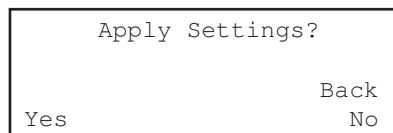

To save the changes, choose the **Exit, Save Change** item by pressing the adjacent soft key.

To exit without saving the changes, choose the **Exit, No Change** item.

To return to the previous screen without saving the changes, choose the **Go Back** item.

To set the address of the GPIB port using the command line:

1. Establish a session with the generator using either HyperTerminal over a serial connection or Telnet over an Ethernet LAN. See [“Establishing a terminal session with the 882”](#) on page 30 or [“Establishing a Telnet session with the 882”](#) on page 33.
2. (Optional) Enter the following command to check the current address:

GPIB?

3. Enter the following command to set the address:

`GPIB address`

When the address is changed with the GPIB command, the change takes place as soon as the command is issued.

Queries and commands

The GPIB interface is an ASCII command line interface like the RS-232 command line interface. The communications protocol is per IEEE-488.2 specification. Queries and commands consist of four ASCII upper/lower case characters. Commands do not require a response from the generator, while queries cause the generator to respond with the required data.

You can send multiple commands on the same line by separating the commands with a semicolon (;) followed by a terminator. A terminator is defined as the NL character (ASCII 10), or EOI sent with the last byte of the command. The generator will not parse any commands received until a terminator is received. All commands are executed sequentially; that is, when a command is parsed it is allowed to finish execution before the next command is parsed, as illustrated in the following figure.

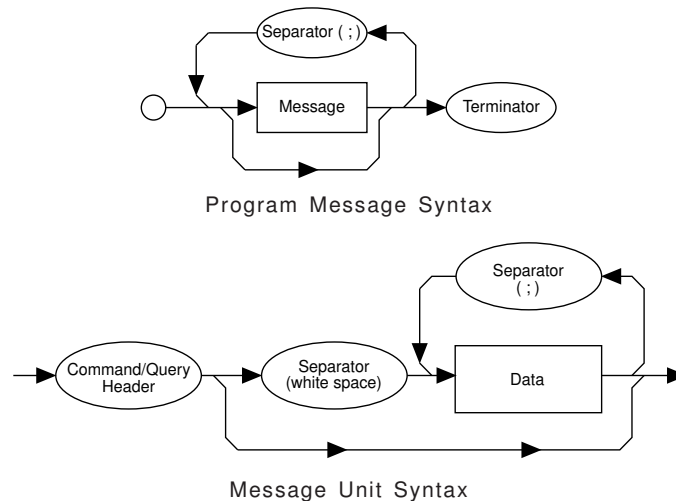

Commands

Commands instruct the generator to set a parameter to the value given or perform some function not requiring any additional data. Commands which have an asterisk (*) as their first character are common commands as defined by the IEEE-488.2 standard and generally operate the same in all instruments. All commands are listed and described in Appendix A, [“Command Reference.”](#)

Commands which do not require any additional data from the controller are self-contained and should be followed by either a message separator (;) or message terminator. Any other characters (except whitespace characters) will cause a command error.

Commands which require numeric data must be followed by at least one separator character (whitespace), and then the data. Numeric data sent with a command is in decimal format. Numeric data can be represented in one of three methods: integer, floating point, or scaled floating point.

For example, the following number can be represented in three ways:

- Integer (42)
- Floating point (42.00)
- Scaled floating point (4.200E+01)

Queries

Queries are comprised of a header followed immediately by a question mark (?). If there are any characters between the query header and the question mark character (including whitespace), a command error will result. Queries return a response message upon completion of execution. A response message is comprised of the requested data terminated with an NL (ASCII 10) character. For example, the following text would be returned in response to the `HRAT?` (horizontal rate query) message:

```
3.1500E+04<NL>
```

Note that the `HRAT?` query returns its parameter in exponential form. Possible returned parameter forms are:

- Integer (3965)
- Exponential (+3.965E+03)
- String ("text string")

Output queue

When a query is executed, the resulting response message is placed in an output queue where it can be read by the controller. The generator has an output queue that is 255 bytes long. When a message is present in the output buffer, the MAV (message available) bit in the Status Byte register is set. This varies slightly from the 488.2 standard in that the MAV bit will be set only when at least one complete response message is present in the output queue. A complete response message consists of response message text and a message terminator (NL).

Buffer deadlock

Buffer deadlock occurs when the generator tries to put a response message in the output queue when the output queue is full and the controller is held off while sending a new message because the input buffer is full. If deadlock occurs, the generator will clear its output queue, set the query error (QYE) bit in the Event Status register and proceed to parse incoming messages. If any additional queries are requested while in deadlock, those response messages will be discarded.

The generator will clear the buffer deadlock when it finishes parsing the current command/query. The QYE bit will remain set until read with the `*ESR?` query or cleared with the `*CLS` command.

Sending commands and queries

The generator parses command lines one at a time. Command lines must be terminated with a carriage return (<cr>). The generator immediately echoes each character as it is received and places it in a command line buffer. This buffer currently has room for a total of 256 characters. If more than 256 characters are sent before sending a <cr>, then the following response will be given:

```
Buffer overflow<cr><lf><cr><lf>R:\>
```

Upon receiving a carriage return, the generator immediately echoes the <cr> and follows it with a line feed (<lf>). The generator then parses the command line and initiates whatever processing is implied. The generator then responds with one of the following four responses depending on the condition:

```
Command invalid<cr><lf><cr><lf>R:\>
```

```
<message1><cr><lf><message2><cr><lf>...<messageN><cr><lf><cr><lf>R:\>
```

```
Execution error: <nnnn><cr><lf><cr><lf>R:\>
```

```
R:\>
```

Where <cr> and <lf> are the carriage return and line feed characters, respectively.

Note: Handshaking routines should only look for > and not R:\>. In the future, the R:\ part of the prompt may change (for example, may be expanded to indicate the current path).

Bench-top generators output the following prompt on their serial port after finishing the power-on procedure.

```
R:\>
```

This feature allows ATE systems to know when the generator is ready.

Sending multiple commands and queries per line

You can send multiple commands and queries per line by separating each command or query with a semi-colon (;) character. For example:

```
HRES 900; ALLU
```

The response to multiple queries will be a series of data elements separated by semi-colons (;). For example, with the VGA_m3 format loaded, the following command string will produce the response shown.

```
HRES?; VRES?; VTOT?  
640;480;525
```

Normally, all of the commands on a command line associated with a single command terminator are read as a single command message without regard for execution or completion order. However, by inserting the *WAI command, you can force the generator

to wait for all preceding commands to be completed before the commands that follow *WAI are processed. For example, sending the following command line causes a red rectangle to be drawn and then overwritten by the ColorBar image.

```
IMGL COLORBAR; IMGU; IMGE; RECT RED 200 200 0 0 GRAYPAT100
```

Note that the IMGU command merely requests that the current image be rendered eventually, not necessarily right away nor in a single attempt. By inserting a *WAI command after the IMGU, the generator is instructed to render the ColorBar image first, before rendering the red rectangle. This command ensures that the generator draws the red rectangle on top of the ColorBar image.

```
IMGL COLORBAR; IMGU; *WAI; IMGE; RECT RED 200 200 0 0 GRAYPAT100
```

The generator will wait until the ColorBar image has been completely rendered before it reads and executes the RECT command.

The *WAI command is required by the IEEE-488.2-1992 standard, but also works with GPIB and RS-232 protocols as well.

Completion handshake

The generator returns a > prompt immediately after an FMTU, IMGU, ALLU, BOOT, INIT, or SCAL command is received, even if these commands have not finished executing. If the system controlling the generator must know when the process started by one of these commands has been completed, then append *OPC? to the command string.

For example, the following command causes the generator to wait until all processes have been completed before responding with the number 1 and sending the > prompt.

```
FMTL VGA_M3; IMGL FLAT; ALLU; *OPC?
```

The *OPC? command is required by the IEEE-488.2-1992 standard, but also works with GPIB and RS-232 protocols as well.

Input buffer

Since some commands may take longer to execute, the generator has an input buffer. This input buffer is 255 characters long and can be written to by the host controller while the generator is busy executing or parsing previous messages. If the input buffer becomes full, the generator will hold off the controller until there is room in the buffer. For this reason, a program message cannot be longer than 255 characters including terminator.

Status queries and control

To create applications that control the generator using the GPIB port, it is sometimes necessary to query the status of the generator and set or reset the status bits and bytes. There are two sets of status registers: 1) the Event Status Register and Event Status Enable Register and 2) the Status Byte Register and Service Request Enable Register. These are described in the following paragraphs.

Status byte

The status byte used by the generator is the same as that defined by the IEEE-488.2 standard and does not use any other bits of the status byte. The status byte is one part of a complete status reporting system shown in the figure on page 166. The status byte is read by using the serial poll feature of your controller.

Requesting service

The GPIB provides a method for any device to interrupt the controller-in-charge and request servicing of a condition. This service request function is handled with the status byte. When the RQS bit of the status byte is true, the generator is requesting service from the controller. There are many conditions which may cause the generator to request service. For more information about these conditions, see the [*SRE](#) command description (page 472). The table below lists the status commands and queries.

Status commands and queries	Definition
*ESE	Sets the Event Status Enable register to the given mask value. When a bit in the Event Status register goes high and the corresponding bit in the Event Status Enable register is a 1, it is enabled and will cause the ESB bit in the Status Byte register to go high.
*ESR??	Returns the current value of the Event Status register. After this command is executed, the Event Status register is cleared. This is the only way of clearing any bit in the Event Status register except by the *CLS command.
*SRE	Sets the Service Request Enable register to the mask value given. When a bit in the Status Byte register goes true and the corresponding bit in the Service Request Enable register is also true, the generator will request service using the GPIB.
*SRE?	Returns the current value of the Service Request Enable register.
*STB?	Returns the current value of the Status Byte register. The value stored in the Status Byte register is not affected by reading it.
*CLS	Clears the Event Status register, the Status Byte, and the output buffer.

The following figure illustrates IEEE-488 status reporting.

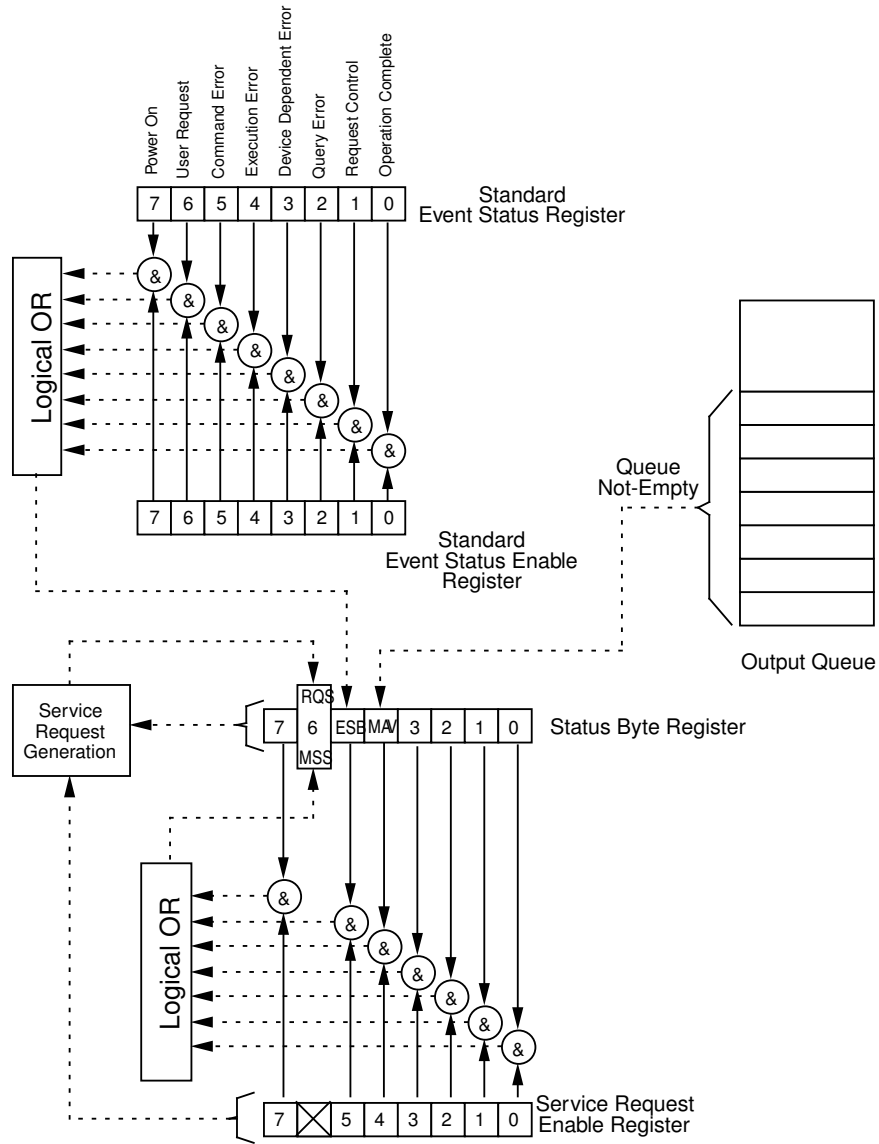

Status byte bit Definition

MAV	Message available. Indicates that at least one complete response is present in the output buffer.
ESB	Event status bit. Indicates that one of the enabled conditions in the Standard Event Status register is set.
MSS	Master summary status. Indicates that the generator has a reason for requesting service.
RQS	Request service. This bit is read only by executing a serial poll of the generator.

Event Status bit	Definition
OPC	Operation complete. Indicates that all operations have been completed.
RQC	Request control. Indicates that a device is requesting control. The generator will never request control, so this bit will always be 0.
QYE	Query error. Indicates that a query request was made while the generator was in deadlock.
DDE	Device dependent error. Indicates that the generator encountered an error executing a command.
EXE	Execution error. Indicates that there was an error parsing a parameter.
CME	Command error. Indicates that there was an unrecognizable command.
URQ	User request. Indicates that a front panel key has been pressed or that the front panel knob has been turned.
PON	Power on. Indicates that power has been turned off and on. This bit will always be 0 in the generator.

Bus commands

The IEEE-488.1 standard defines bus commands, which are sent to the generator with ATN true. The following table lists bus commands supported by the generator. For more detailed descriptions of these commands, see the IEEE-488.1 and 488.2 standards.

Command	Description
DCL	Device clear. Clears the input buffer and output queue, and stops parsing any commands.
SDC	Selected device clear. Same as DCL.
GTL	Go to local. Enters the local state. See “Remote/local operation” on page 167.
LLO	Local lockout. Enters the lockout state. See “Remote/local operation” on page 167.
SPE	Serial poll enable. Enables transmission of the Status Byte.
SPD	Serial poll disable. Exits the serial poll state.

Remote/local operation

The generator has complete remote/local operation as defined by the IEEE-488.1 standard. All four remote/local states (REMS, LOCS, RWLS and LWLS) are supported.

In the remote state (REMS), the generator is under remote control and messages are processed as received. The generator enters the remote with lockout state (RWLS) if the controller issues the local lockout (LLO) message to the generator. The generator enters the local state (LOCS) when the REN line goes false or the controller issues the go to local (GTL) message to the generator, or a front panel control is actuated.

In the remote with lockout state (RWLS), the generator is under complete remote control and front panel controls are disabled. The generator enters the RWLS state when the controller issues the local lockout (LLO) message to the generator. Front panel access is re-enabled when the controller issues the go to local (GTL) message to the generator.

In the local state (LOCS), the generator is under local control and all front panel controls are enabled. Any remote messages received are stored for processing when the generator enters the remote state again. The generator enters the remote state (REMS) if the REN line is true and the generator is addressed to listen.

In the local with lockout state (LWLS), the generator is under local control, and all front panel controls are enabled. Any remote messages received are stored for processing when the generator enters the remote state again. The generator enters the remote with lockout state (RWLS) if it is addressed to listen.

6 Working with Formats

Topics in this chapter:

- [Overview](#)
- [Format library](#)
- [Viewing the source list of formats](#)
- [Configuring format parameters](#)
- [Format Editor Overview](#)
- [Creating a new format using the Format Editor](#)
- [Creating custom formats using the command line interface](#)
- [Format catalogs](#)

Overview

The generator contains a library of standard formats. You can create your own formats, however, either by using the Format Editor or by entering format commands through the command line interface. You can also create format catalogs which allow you to control the formats that appear on the generator's display when you press the **Source** key.

This chapter describes the format library and provides procedures for using the generator's front panel keys, the command line interface, and the format editor to view formats, create and customize formats, and create format catalogs.

The following functions are described in this chapter:

- **Viewing the Source list of formats.** You can view the Source list of formats using the front panel or the command line interface.
- **Creating formats.** You can create new formats through the format editor or the command line interface.
- **Viewing and modifying format parameters.** You can view and edit format parameter values either through the format editor, the front panel, the command line interface, or by editing the format XML file.
- **Configuring the Source list.** You can edit the **Source** list of formats to include only those formats you use.

Format library

The generator has a built-in library of formats which are stored as XML files in any of the generator's media. This section describes three sets of naming conventions for identifying formats: 1) Composite television formats, 2) Component television formats, and 3) Computer display formats. In addition, several miscellaneous naming conventions are also described.

Composite television format names

Composite television formats apply to RF, D2, CVBS, and S-VIDEO signal interfaces. Composite television format names consist of a three to five character color coding scheme indicator followed by optional characters that indicate format adjustments.

Example

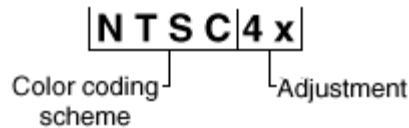

Color coding schemes

- NTSC
- PAL

Adjustments to the format

- 4x == sampling rate is four times the color sub-carrier frequency
- 44 == NTSC with color sub-carrier frequency of 4.43361875 MHz (as opposed to 3.58)
- # == sampling rate is reduced in order to make pixels square
- jp == NTSC-Japan (NTSC without 7.5 IRE setup)
- -M == PAL with 3.57561149 MHz color sub-carrier and M timing (M/PAL Brazil)
- -N == PAL with 3.58205625 MHz color sub-carrier (N/PAL Argentina, Paraguay, Uruguay)
- -N == NTSC color encoding with N timing (NTSC-N)
- -60 == PAL format that allows NTSC tape playback on PAL TV (PAL-60)
- plusKKKK == Enhanced wide-screen PALplus TV transmission system
- p == progressive video game signal (for example, NTSCp or PALp)

Common composite TV formats with sub-carriers and their respective standards:

- NTSC - ITU-R BT.470-6
- NTSC# - SMPTE 170M
- NTSC#KA - SMPTE 170M
- PAL - ITU-R BT.470-6
- PAL# - ITU-R BT.470-6
- PAL#KA - ITU-R BT.470-6

Component television format names

Component television formats are named by their vertical resolution and scanning method. These formats apply to RGB, YPbPr, YcbCr and HD-SDI video. In component television format naming, the first three or four characters indicate the active vertical lines in the format, the next characters indicate the frame tracing method, and the last two optional characters indicate the frame rate.

Example

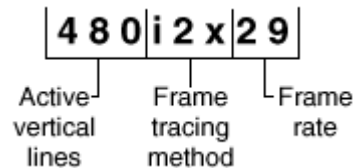

Active vertical lines

- 480 (active lines with 525 total lines)
- 1035 (active lines with 1125 total lines)

Frame tracing methods

- p = progressive
- i = interlaced
- s = segmented frame interlace (e.g., 1080s24, where a 24p frame is segmented into two interlaced fields occurring at twice the frame rate - scene changes only between field pairs – also known as “48sF”)
- x = any – progressive, interlace, or segmented

Double clocking

- i2x = double-clocked interlace (scene may change between fields) pixels are double-clocked for DVI compatibility)

Frame rate

Frame rate is optional. If no frame rate is given, then the frame rates are assumed.

- 24 = 24 Hz
- 60 = 60 Hz

Common component TV formats

- 480pLH Component SDTV signal containing letterboxed 16x9 high-definition content
- 480pSH Component SDTV signal containing anamorphically under-sampled 16x9 content

Computer display format names

Computer display formats are assumed to use progressive scanning. In computer format naming, the first three characters indicate the vendor ID using the EISA ID (for example, IBM, SUN, VSC) or the display type, the next two characters indicate the approximate horizontal resolution, the next two digits indicate the frame rate (which will be half the field rate with interlace scanning), and the final character designates the aperture (used only when the aperture is not A).

Example

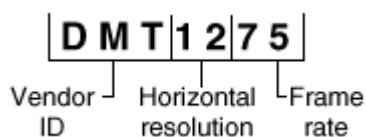

Vendor ID (EISA)

- SMT for VESA (digital) Safe Mode Timing
- DMT for VESA Standard Discrete Monitor Timing
- GTF for VESA Generalized Timing Format standard
- CEA for Consumer Electronics Association
- EIA for Electronics Industries Association (CEA)

Approximate horizontal resolution examples

- 02 for 256 pixels
- 09 for 960 pixels
- 12 for 1200 pixels
- 30 for 3072 pixels

Frame rate examples (half the field rate with interlace scanning)

- 48 for 48 Hz
- 60 for 60 Hz
- 75 for 75 Hz

Aperture (used only when the aperture is not A)

See "[Aperture designators](#)" on page 174.

Common computer display formats

- VSC1275 for Viewsonic 1280 by 1024 at 75 Hz
- DMT0685 for Discrete Monitor Timing with 680 by 480 at 85 Hz

Aperture designators

Format names may include one or two characters that describe the aperture of the display. These are listed below.

Aspect ratio

- Q = 1.00:1 Quadrate - MIL, Radiology (square, 512x512, 1024x1024)
- G = 1.25:1 Graphics workstation (5x4, 1280x1024, 1600x1280)
- A = 1.33:1 Academy (4x3, 640x480, 800x600, 1024x768, 1280x960, 1600x1200)
- B = 1.44:1 Big (13x9, IMAX™)
- T = 1.50:1 Three halves (3x2, 1152x768 Apple Computer)
- V = 1.56:1 PALplus WWS case #2 (14x9, see ITU-R BT.1119)
- D = 1.60:1 VESA CVT proposed (16x10, 1728x1080, 1280x800)
- E = 1.67:1 European film (15x9 or 5x3, 1200x720, 1280x768, 1800x1080, a.k.a. "1.66")
- H = 1.78:1 High-definition image (16x9, 1280x720, 1920x1080)
- F = 1.85:1 US film (320x173, 1280x692, 1920x1038)
- U = 2.00:1 Univisum™ (2x1, 1280x640, 1920x960)
- C = 2.39:1 CinemaScope™ (160x67, 1280x536, 1920x804, a.k.a. "2.35", was 2.35 before 1971)

Content fitting operators

- N = Natural (do nothing)
- L = Letterbox (linear scale to fit one axis, center w/black bars in other)
- Z = Zoom (blow- up to fill destination aperture with cropping, or LI)

- S = Scope (under-sample content horizontally)
- W = Widescreen (over-sample content horizontally)
- J = Justify (non- linear horizontal expand – more near edges)
- K = Keep safe (shrink to avoid cropping – provide safe title)
- P = Pan & Scan (truncate)
- M = Mirror (horizontally – rear projection)

Other modifiers

- I = Inverse (undo operator; for example, S = Scope and SI = Inverse Scope)
- O = Orthogonally (rotate operator effect or aperture 90 degrees)
- X = Wildcard or special

Viewing the source list of formats

You can view the list of formats available in the generator using the front panel or the command line interface. Use the following procedures to view the Source (format) list.

Note: The Source list of formats that appears on the generator's display is determined by the format path. In addition, the list may be filtered based on the interface selected and the format catalogs that are enabled. For more information about setting the path, see "[Setting the 882's path](#)" on page 17. For more information about format catalogs, see "[Format catalogs](#)" on page 223.

To view the formats in the Source list using the front panel:

Press the **Source** key. The list of formats appears on the generator's display as shown below. To see all of the formats, press the + and - keys to scroll through the list.

*DMT0660	DMT0672
DMT0675	DMT0685
DMT0785H	DMT0856
DMT0860	DMT0872

To view the formats in the Source list using the command line interface:

1. Establish a session with the generator using either HyperTerminal over a serial connection or Telnet over an Ethernet LAN. See "[Establishing a terminal session with the 882](#)" on page 30 or "[Establishing a Telnet session with the 882](#)" on page 33.
2. Set the path to the format folder on the medium you want to view using the following command:

```
FMTF /tffs0/Library/Formats // sets format path to flashmen directory
```

3. List the contents of the format folder by entering the following command:

```
FMTQ? 1 200 // lists the formats from 1 through 200
```

Configuring format parameters

Each standard and custom format is defined by a set of parameters. These parameters are categorized in the generator as either Options or Settings. You can view and modify the parameters of a format in the following ways:

- On the generator's front panel display
- On a display connected to the generator (view only)
- Through the command line interface
- In the format's XML file
- Through the Format Editor

Viewing and modifying format parameters through the front panel

Procedures for viewing and modifying the format parameters and format options through the front panel are provided below. Format options are selections that are of a binary nature, i.e. either on or off. Settings are attributes of a format that can take on a wider range of values.

Note that format setting and option changes made through the front panel do not persist through power cycles or changes in formats. If you make a change to a format parameter, then choose another format, and then go back to the format you changed, you will find that the parameter has been reset to the default value for that format.

To view and modify a format's options using the front panel:

1. Press the **Source** key and choose a format by pressing the adjacent soft key.
2. Press the **Options** key. The format options appear on the generator's display as shown below.

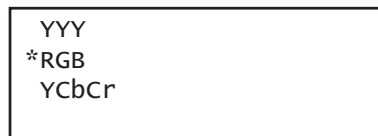

3. To set an option, do one of the following:
 - a. To choose an option, press the soft key adjacent to the option. An asterisk (*) appears next to the option, indicating it is selected.
 - b. To enable or disable an option, press the soft key adjacent to the option. A + sign indicates the option is enabled; a - sign indicates it is disabled.
 - c. To set an option to a value (for example, AFD), increment the value by pressing the + key.

- To see more options, press the **Options** key again. The following appears on the generator's display as shown below.

```
*FullRange
ShootRange
LimitedRange
```

- To see more options, press the **Options** key again. The following appears on the generator's display as shown below.

```
*ACS          SyncOnR+
DCS           SyncOnG+
DSS           SyncOnB+
-Pedestal     TriLevel+
```

- Press the **Options** key again to see additional options for testing digital displays. The following appears on the generator's display as shown below.

```
+ShotProtect  AFD: 0
*Production
SafeAction    Action-
SafeTitle     Title-
```

To view and modify a format's settings using the front panel:

- Press the **Source** key and choose a format by pressing the adjacent soft key.
- Press the **Settings** key. The format settings appear on the generator's display as shown below. Press the soft keys adjacent to the arrows to see all of the format settings. Refer to the table below to locate the setting you want to change.

```
Video Signal  ->
Interface     ->
XVSI  AVSI  DVSI
<-  1    3    0  ->
```

- To change a setting value:
 - Position the blinking cursor on the value you want to change. To do this, press the soft key adjacent to the arrow by the setting value to move the cursor left or right until it appears on the digit you want to change.
 - Adjust the value of the setting up or down by pressing the + or - keys.

4. To save the changes, press the **Enter (Options)** key. The following choices appear on the generator's display:

Apply Settings?	
Yes	Back No

To save the changes, choose the **Yes** item by pressing the adjacent soft key.

To exit without saving the changes, choose the **No** item.

To return to the parameters screen without saving the changes, choose the **Back** item.

The following table shows the layout of the format Settings menu.

Parameter Class	Parameter Type	Parameters
Video Signal	Interface	XVSI, AVSI, DVSI
	Synchronization	SSST
	Gamma Correction	GAMA, GAMC
	Active Format	CXAR, EXAR, SXAR, EXCX, SXEX, SXCX, XAFD
	Manual Border	XLBW, XRBW, XTBH, XBBH
	Canvas	PELD, NPPP
	Analog Video	AVST, AVSS, AVSB, AVPS, AVPG, AVCS
	Analog Sync	ASSS, ASCT, EQUF
	Analog Sync Gates	ASRG, ASGG, ASBG, TSPG
	Digital Video	DVST, DVQM, NCPP, NBPC, NLNK, CTLM, BALG, PREG, DVSP, DVPT, DVSM, DVSS
	Digital Sync	DSST, DSCT
	Digital Sync Polarity	HSPP, VSPP, CSPP, FSPP, PSPP
	Digital Sync Gates	HSPG, VSPG, CSPG, PSPG, LSPG, FSPG, PCPG
	Video Timing	Rates
Horizontal		HTOT, HRES, HBNK
Vertical		VTOT, VRES, VBNK, SCAN, RFLD
Horizontal Sync		HSPD, HSPW, HSPB, HVPD
Vertical Sync		VSPD, VSPW, VSPB
Composite Sync		HBPD, HBPW, HEPW, EQUB, EQUA, HVSA
Frame Sync		FSPD, FSPW
Probe Sync		PSHD, PSVD, PSPW, PSPM
Audio Signal	Interface	DASI

Parameter Class	Parameter Type	Parameters
	Encoding	DAST, NDAS, NDAC, NBPA
	Components	DAXG, DAXA
	Mix	SDMG, DADG, DAL5
	Channels	DACA, DACG
Audio Timing	Sampling Rate	ARAT, BRAT

To view a format's parameters on a display connected to the generator:

1. Press the **Source** key and choose a format by pressing the adjacent soft key.
2. Press the **Content** key and choose the **Format** image. The format parameters appear on the connected display.

```

Name: DM10660                               Pixel Rate:
Location: 151                                25.200 MHz    39.683 ns
Entry units: Machine
                                         Horizontal      Vertical
Rate:          31.500 KHz*                  60.000 Hz
Active:         640 pixels*  25.397 us      480 lines*   15.238 ms
Blank:          100 pixels*   6.349 us      45 lines*    1.429 ms
Period:         800 pixels*  31.746 us      525 lines*   16.667 ms
Physical size:  11.200 inches 284.480 mm   8.400 inches 213.360 mm
Pulse delay:    15 pixels*   0.635 us      10 lines*   0.317 ms
Pulse width:    96 pixels*   3.810 us      2 lines*    0.063 ms
EQ Before:      0 lines
EQ After:       0 lines
Scan:           Progressive (non-interlace)
ACS kind:       American 0Red                On: -G-
DCS kind:       American 0Red
DSS kind:       American separate           DS Polarity: H- U- C-
Sync select:    DSS                          DS Gate: Hon Von Con
Video kind:     Analog RGB (color)           Pedestal: OFF 7.5 IRE
Video bias:     0.000 volts blank minus ground
Video swing:    0.700 volts white minus blank
Sync swing:     0.300 volts blank minus sync
Gamma:          OFF 2.200
Display code expected: E Code read: F

```

To view format parameters for all formats in the Source list:

1. Display the Format image as described above.

2. Enable and view image versions as follows:

a. Press the **Options** key. The following menu appears on the generator's display:

```
-More
-Noise          Red+
-Noise          Green+
-Noise          Blue+
```

b. Choose the **More** item by pressing the adjacent soft key until a + and Rendition appears next to the item.

```
+More Rendition: 000
-Noise          Red+
-Noise          Green+
-Noise          Blue+
```

c. Press the + and - keys to advance through the image versions. Each version shows the format parameters for a different format in the Source list.

Alternatively, to enable and view image versions using the command line interface, enter the following commands:

```
ISUB 1 // Enables sub images
IVER 1 // Specifies the first image version
IMGU // Activates the image version
```

3. When you are finished, disable image versions by pressing the **Options** key and choosing **More** until a - appears next to it.

Alternatively, to disable image versions using the command line interface, enter the following command:

```
ISUB 0 // Disables sub images
```

Viewing and modifying format parameters via the command line

Procedures for viewing and modifying the format parameters through the command line are provided below.

To view and modify a format's options using the command line interface:

1. Establish a session with the generator using either HyperTerminal over a serial connection or Telnet over an Ethernet LAN. See "[Establishing a terminal session with the 882](#)" on page 30 or "[Establishing a Telnet session with the 882](#)" on page 33.
2. Load the format whose parameters you want to view by entering the following command:

```
FMTL format // Specify a valid format name
FMTU
```

3. To view options, enter the commands for the format options you want to view. For example, to view the sync configuration, enter the following command:

```
ASSG?
```

The generator responds with the information as shown below:

```
0, 1, 0 // Indicates no sync on red, sync on green, no sync on blue
```

4. To modify options, enter the format commands with the new values. For example, to enable sync on red and disable sync on green, enter the following commands:

```
FMTL DMT0660 // Load DMT0660 for editing
ASSG 1, 0, 1 // Enable sync on red, disable sync on green
FMTU // Apply the changes to the generator
```

To view and modify a format's parameter settings using the command line interface:

1. Establish a session with the generator using either HyperTerminal over a serial connection or Telnet over an Ethernet LAN. See [“Establishing a terminal session with the 882”](#) on page 30 or [“Establishing a Telnet session with the 882”](#) on page 33.
2. Load the format whose parameters you want to view by entering the following command:

```
FMTL format // Specify a valid format name
FMTU
```

3. To view parameters, enter the commands for the format settings you want to view. For example, to view the horizontal resolution, vertical resolution, horizontal period, and analog video sync type, enter the following command:

```
HRES?; VRES?; HTOT?; AVST?
```

The generator responds with the information in sequence as shown below:

```
640;480;800;2
```

4. To modify settings, enter the format commands with the new values. For example to modify the horizontal resolution and the horizontal sync pulse delay for DMT0660, enter the following commands:

```
FMTL DMT0660 // Load DMT0660 for editing
HRES 660 // Change horizontal res. from 640 to 660 pixels
HSPD 10 // Change pulse delay from 16 to 10 pixels
FMTU // Apply the changes to the generator
```

Viewing and modifying format parameters by editing XML files

Procedures for viewing and modifying the format parameters by editing the format XML files are provided below.

To view and modify a format's parameter values in the format's XML file:

1. Using the Generator FTP Browser, copy the format's XML file from the generator to a PC. See ["Copying files from a 882 to a PC"](#) on page 25 for instructions.
2. Open the XML file in a standard text editor.
3. To modify parameters in the XML file, do the following:
 - a. Make your changes in the XML file, and then save the file under a new file name, including the .xml extension.
 - b. Using the Generator FTP Browser, download the format XML file from your PC to the generator. See ["Copying files from a PC to a 882"](#) on page 23 for instructions.

A sample format XML is shown below.

```
<?xml version="1.0" encoding="UTF-8" ?>
<DATAOBJ>
  <HEADER TYPE="FMT" VERSION="1.0" ></HEADER>
  <DATA>
    <AVPS>+7.5000000E+00</AVPS>
    <GAMA>+2.2000000E+00</GAMA>
    <AVSS>+0.7000000E+00</AVSS>
    <ASSS>+0.3000000E+00</ASSS>
    <HSIZ>+1.1200000E+01</HSIZ>
    <VSIZ>+8.3999996E+00</VSIZ>
    <HRAT>+3.1500000E+04</HRAT>
    <TUNE>+1.0000000E+00</TUNE>
    <HRAT0>+3.1500000E+04</HRAT0>
    <HRES>640</HRES>
    <HTOT>800</HTOT>
    <VRES>480</VRES>
    <VTOT>525</VTOT>
    <HSPD>16</HSPD>
    <HBPD>0</HBPD>
    <HSPW>96</HSPW>
    <VSPD>10</VSPD>
    <VSPW>2</VSPW>
    <EQUB>0</EQUB>
    .
    . // other parameters omitted
    .
    <SXAR>+1.3333334E+00</SXAR>
    <EXAR>+1.3333334E+00</EXAR>
    <NPPP>0</NPPP>
    <EXCX>0</EXCX>
    <XLBW>0</XLBW>
    <XRBW>0</XRBW>
    <XTBH>0</XTBH>
    <XBBH>0</XBBH>
    <DVSS>+1.0000000E+00</DVSS>
    <DVPT>0</DVPT>
  </DATA>
</DATAOBJ>
```

Format Editor Overview

The Format Editor provides a graphical user interface for modifying existing formats, creating custom formats and viewing format parameters. The Format Editor is part of the generator's Web server and is accessed over an Ethernet LAN connection using a Web browser, such as Microsoft Internet Explorer. You can also test formats on the generator directly from the Format Editor.

Note: The Format Editor has been updated with release 2.18. Releases prior to that will have the original version of the application. The information below pertains to the new Format Editor. This Format Editor requires Internet Browser version 6.x or newer. If you have Internet Browser version 5.x you will need to upgrade.

The main screen of the Format Editor is shown below.

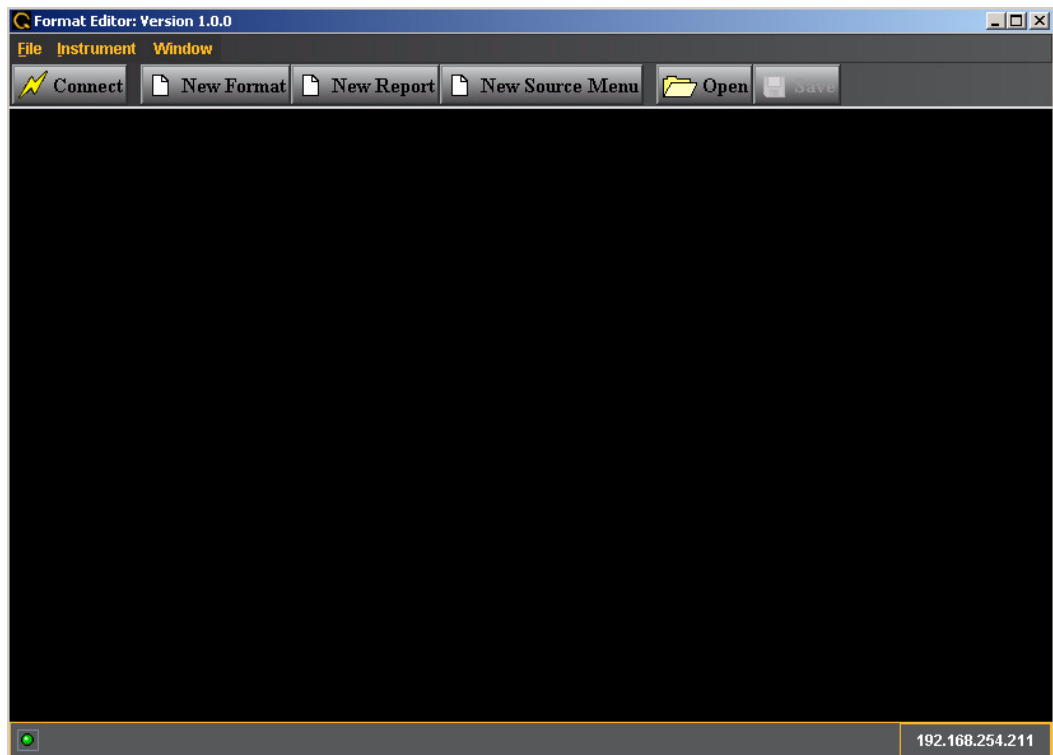

Format Editor - Basic Window Configuration and Operation

The Format Editor is a windowing application. You can open up many windows at one time. They can be floating or docked in the main window. The activation buttons appear in the upper right corner of a window. They are shown in the figure below.

In this figure, clicking on the left most activation button will cause the window to become an icon in the lower left corner of the Format Editor main window.

Clicking on the activation button in the center of the figure below will dock the window into the main Format Editor window such that it will occupy the entire window opening of the Format Editor.

Clicking on the right most activation button in the figure below will close the window.



Format Editor - Top Level Menus

The top level menus of the Format Editor are shown below.

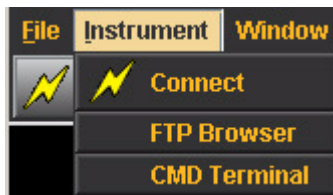
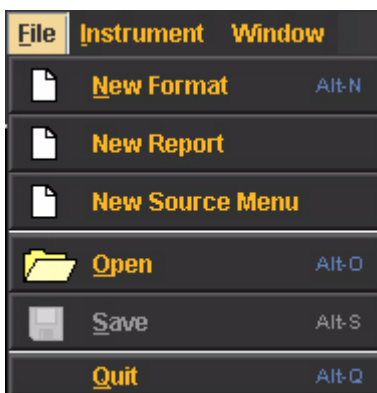

The following table describes the top level menus in the Format Editor.

Menu	Description
File	
	New Format
	Opens up the New Format - Timing window. Enables you to create new formats (equivalent to clicking on the New Format activation button).
	New Report
	Opens up the Report Format window (equivalent to clicking on the New Report activation button). Enables you to view list of formats and their primary parameters.

Menu	Description
New Source Menu	Opens up the Source Menu (equivalent to clicking on the New Source Menu activation button).
Open	Enables you to browse to and open an xml format file on your PC. This is equivalent to clicking on the Open activation button.
Save	Enables you to save an xml format file on your PC. This is equivalent to clicking on the Save activation button.
Quit	Closes out the Format Editor.
Instrument	
Connect	Enables you to establish a connection between the Format Editor and the 882E. A dialog pops up to enable you to enter the IP address of the 882E you wish to connect to.
FTP Browser	Opens up the FTP browser application which enables you to transfer files between your host PC and the 882E generator that you are connected to.
CMD Terminal	Opens up the CMD Terminal application which enables you to enter commands to the 882E generator that you are connected to.
Window	
Message Log	Check box enables or disables message logging.

Format Editor - Menu Buttons

The activation buttons of the Format Editor are shown in the window below.

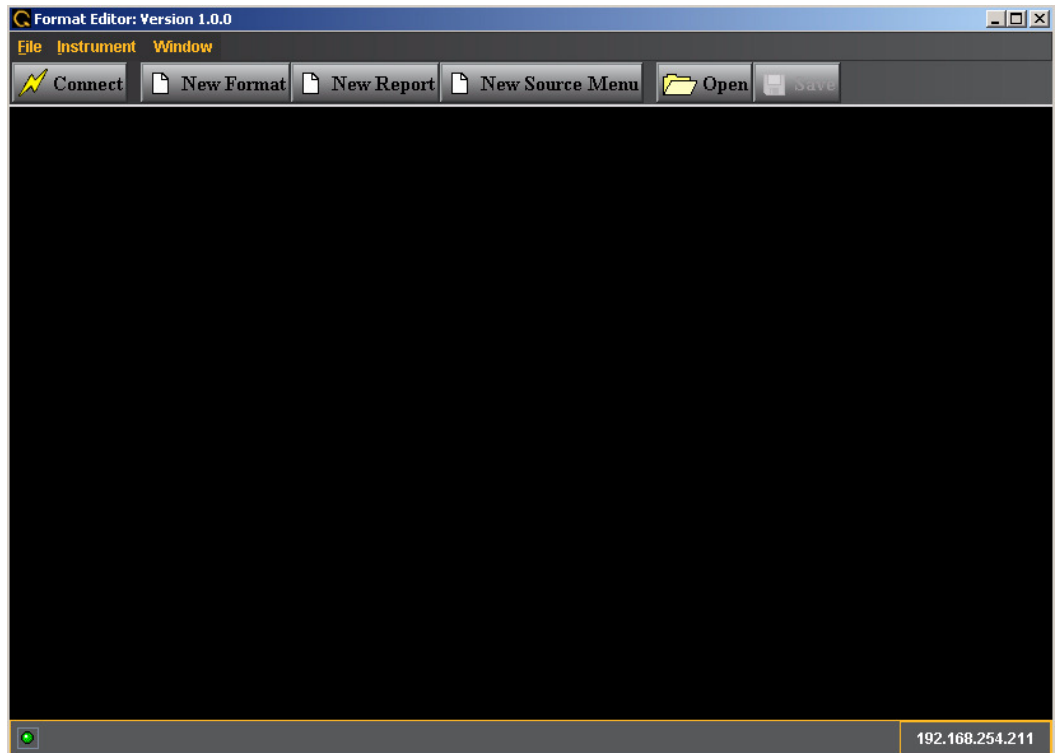

The following table describes the Format Editor menu buttons.

Button	Description
Connect	Clicking on this button enables you to establish a connection between the Format Editor and the 882E. A dialog pops up to enable you to enter the IP address of the 882E you wish to connect to. This is equivalent to selecting the Instrument Connect pull down menu.
New Format	Opens up the New Format at the Timing tab. Enables you to create new formats. This is equivalent to selecting the New Format from the File menu.
New Report	Opens up the Report Format window. This is equivalent to selecting New Report from the File menu. Enables you to view list of formats and their primary parameters.
New Source Menu	Opens up the Source Menu. This is equivalent to selecting New Source from the File menu.
Open	Enables you to browse to and open an xml format file on your PC. This is equivalent to selecting Open from the File menu.
Save	Enables you to save an xml format file on your PC. This is equivalent to selecting Save from the File menu.

Format Editor - New Format

This subsection defines the tabs and status panels available with the New Format screen shown below.

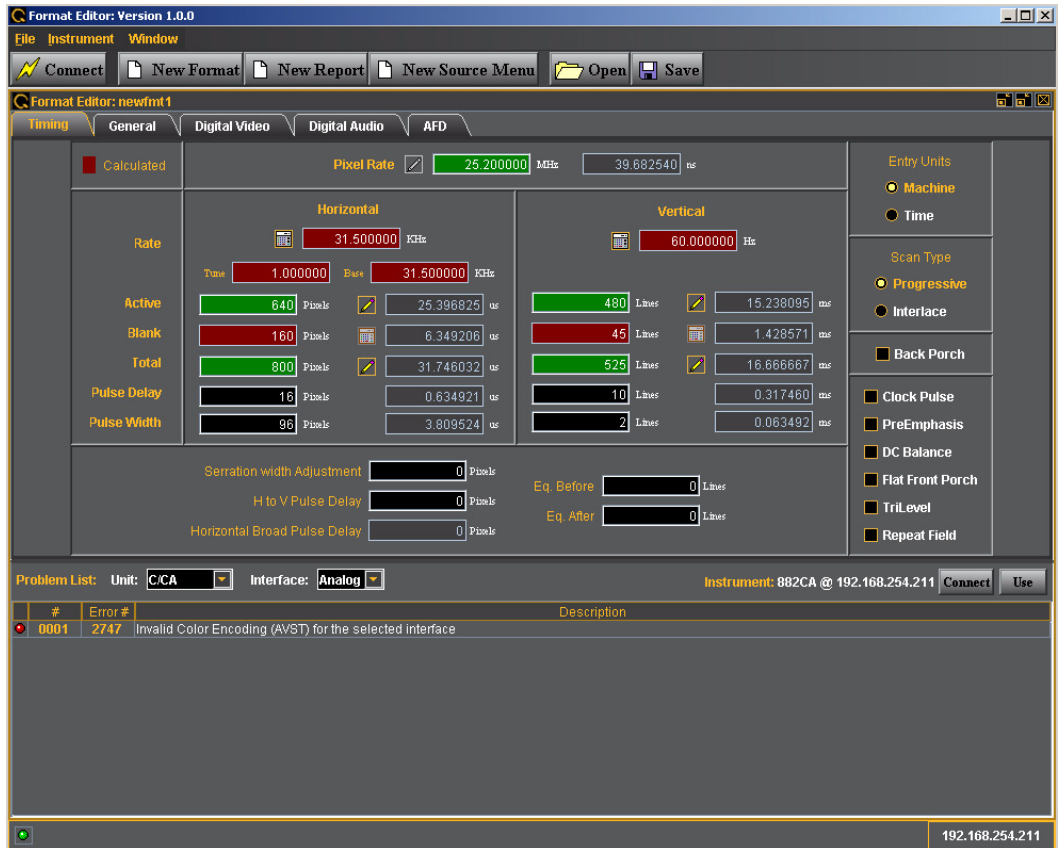

The table below describes the tabs available for the New Format window.

Tab	Description / Function
Timing	Selecting the Timing tab opens up an application screen that enables you to define the timing parameters for a custom format or modify the timing parameters of an existing format. (See “New Format - Timing Tab” on page 190 below for details on each of the parameters.)
General	Selecting the General tab opens up an application screen that enables you to define the sync, level, pixel depth, gamma and pedestal parameters for a custom format or modify these parameters of an existing format. (See “New Format - General Tab” on page 194 below for details on each of the parameters.)
Digital Video	Selecting the General tab opens up an application screen that enables you to define the digital video parameters for a custom format or modify these parameters of an existing format. (See “New Format - Digital Video Tab” on page 202 below for details on each of the parameters.)

Tab	Description / Function
Digital Audio	Selecting the General tab opens up an application screen that enables you to define the digital audio parameters for a custom format or modify these parameters of an existing format. (See “ New Format - Digital Audio Tab ” on page 204 below for details on each of the parameters.)
AFD	Selecting the General tab opens up an application screen that enables you to define the AFD parameters for a custom format or modify these parameters of an existing format. (See “ New Format - AFD Tab ” on page 207 below for details on each of the parameters.)

The table below describes the Problem List status panels for the New Format window.

Entity	Type	Description / Function
Unit	Pull-down menu	Enables you to select the type of 882 unit that you are viewing problems for. Options are: <ul style="list-style-type: none"> • C/CA - 882C or 882CA • D - 882D • E - 882E • EA/DP - 882E (HDMI), 882EA (HDMI), 882E (DisplayPort) •
Interface	Pull-down menu	Enables you to select the type of interface you are defining a format for. Options are: <ul style="list-style-type: none"> • Analog - Component analog (RGB or YPbPr) • CVBS - Composite Video Baseband Signal • S-Video - Y/C • DVI - DVI from the DVI output • HDMI-D - DVI from the HDMI output • HDMI-H - HDMI • SDI - SDI and HDSDI
Instrument (Connection Status)	Status text field	Shows the current connection status.

Error log

Red Dot Indicates that an error has occurred. In the future warnings will be supported which will be yellow.

(Number) An integer assigned to the error in the log list. This is a number assigned in sequence as the errors occur.

Error # The 882 error number for a particular error type. The error list can be found in “[Error code descriptions](#)”.

Description A text description of the error.

New Format - Timing Tab



The Timing window of the Format Editor Timing is shown below. This window is activated by pressing the Timing tab.

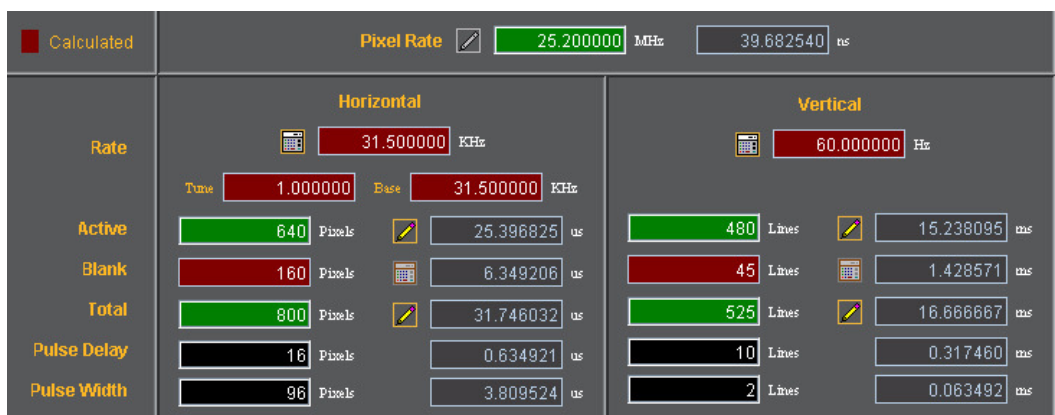

The main panel of the Timing tab is shown below.



The table that follows describes each of the fields in the main panel of the Timing tab.

Entity	Field	Description / Function
Pixel Rate		Sets the pixel rate in pixels (Machine) or microseconds (Time) of the format.
Horizontal		
	Rate	The horizontal line rate of the format. The HRAT is the fundamental frequency in the 882. Parameter: HRAT.
	Tune	The tuning value of the base frame rate (base/tune) for NTSC color broadcast compatibility. The tuning value is base/1.001.
	Base	The base frame rate.
	Active	The number of active pixels (machine) or microseconds (Time) of the horizontal video. Parameter: HRES.
	Blank	The number of active pixels (Machine) or microseconds (Time) of the horizontal video. This parameter is calculated.
	Total	The total number of active pixels (Machine) or microseconds (Time) of the horizontal video. The total is the sum of the Active and Blanking. Parameter: HTOT.
	Pulse Delay	The number of pixels (Machine) or microseconds (Time) in the blanking preceding the horizontal sync pulse. Parameter: HSPD.
	Pulse Width	The number of pixels (Machine) or microseconds (Time) of the horizontal sync pulse. Parameter: HSPW.
Vertical		
	Rate	The vertical frame rate of the format. Parameter: VRAT.
	Active	The number of active lines (machine) or milliseconds (Time) of the vertical video. Parameter: VRES
	Blank	The number of active lines (Machine) or milliseconds (Time) of the vertical video. This parameter is calculated.
	Total	The total number of active lines (Machine) or milliseconds (Time) of the vertical video. The total is the sum of the Active and Blanking. Parameter: VTOT.
	Pulse Delay	The number of lines (Machine) or milliseconds (Time) in the blanking preceding the vertical sync pulse. Parameter: VSPD.
	Pulse Width	The number of lines (Machine) or milliseconds (Time) of the vertical sync pulse. Parameter: VSPW.
 (green calculator)		Indicates that the value in the field is calculated by the Format Editor.
 (red calculator)		Indicates that the value in the field is calculated by the Format Editor, and that the new value has replaced the value previously in the field.

Entity	Field	Description / Function
		Indicates that the values in this field are settable in the current configuration.
	Red Field	Indicates that the fields are in the read only mode. These fields will show a change in value when the value in a field affecting these fields is modified.
	Green Field	Indicates that the fields are in the read/write mode. When you make a change and hit the enter key new values will be calculated.
	Black Field	Indicates that the fields can be modified directly and are calculated when other related fields are modified.
	Gray Field	Indicates that the fields are disabled because the Entry Units are selected such that the fields are not used. However these fields will show a change when the value in a field affecting these fields is modified.

New Format - Timing Tab (Bottom Panel)

The bottom panel of the Timing tab in the Format Editor is shown below.

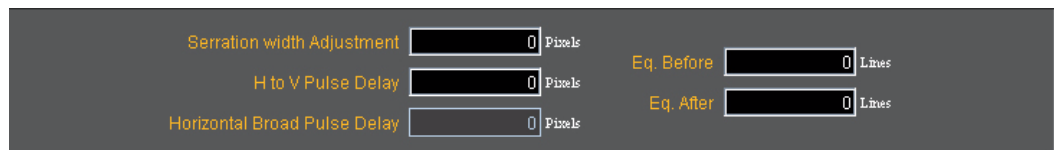

The table that follows describes each of the fields in the panel.

Field	Description
Serration with Adjustment	Sets the length of the serration period on composite video to a given number of pixels from the format's nominal default value as required by some military STANAG video formats. Valid range is in pixels with integer values from 0 to less than HSPW in pixels. Parameter: HVSA
H to V Delay	Displays the current value for the pixel delay between horizontal and vertical sync pulses. Parameter: HVPD?
Horizontal Broad Pulse Delay	
Equalization Before	Establishes the width of the equalization interval before the vertical sync pulse in each field whenever a serrated and equalized sync type is selected via either ACST or DSCT command and the SSST command. Valid values are 0 and number of lines after vertical sync before video. Parameter: EQUB
Equalization After	Establishes the width of the equalization interval after the vertical sync pulse in each field whenever a serrated and equalized sync type is selected via either ACST or DSCT command and the SSST command. Valid values are 0 and number of lines after vertical sync before video. Parameter: EQUA.

New Format - Timing Tab (Right Side Panel)

The right side panel of the Timing tab in the Format Editor is shown below. The table that follows describes each of the fields in the panel.

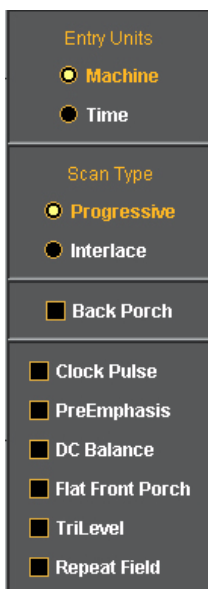

New Format - Timing (Right Side Panel)

Entity	Parameter	Description / Function
Entry Field	Machine	Activates the fields in the timing tab window such that the timing parameter values are expressed and settable in terms of pixels and lines.
	Time	Activates the fields in the timing tab window such that the timing parameter values are expressed and settable in terms of time increments such as milliseconds and microseconds.
Scan Type	Progressive	Sets the format scan type to Progressive. Parameter: SCAN = 2
	Interlace	Sets the format scan type to Interlaced. Parameter: SCAN = 1
check boxes	Back Porch	Toggles the Pulse Delay field so that the value is provided for the back porch rather than the front porch.
	Clock Pulse	Enables and disables the pixel clock pulse output on generators that have a pixel clock output available. The pixel clock output appears on the special sync BNC connector. Parameter: PCPG.

Entity	Parameter	Description / Function
	PreEmphasis	Enables and disables adding pre-emphasis to the Open LVDI digital outputs on generators that support LVDI outputs.
	DC Balance	Not used
	Flat Front Porch	Determines if composite sync will have all equalization pulses removed in the vertical sync front porch (delay) period as required by certain military HOB0 and Maverik video formats. Parameter: EQUF.
	Tri-Level Sync	Enables or disables Tri-Level sync. Parameter: TSPG
	Repeat Field	Determines if identical video information is output for each field of an interlaced (SCAN = 2) format. Parameter: RFLD.

New Format - General Tab

The Format Editor General tab is shown below. The table that follows describes each of the fields in the tab.

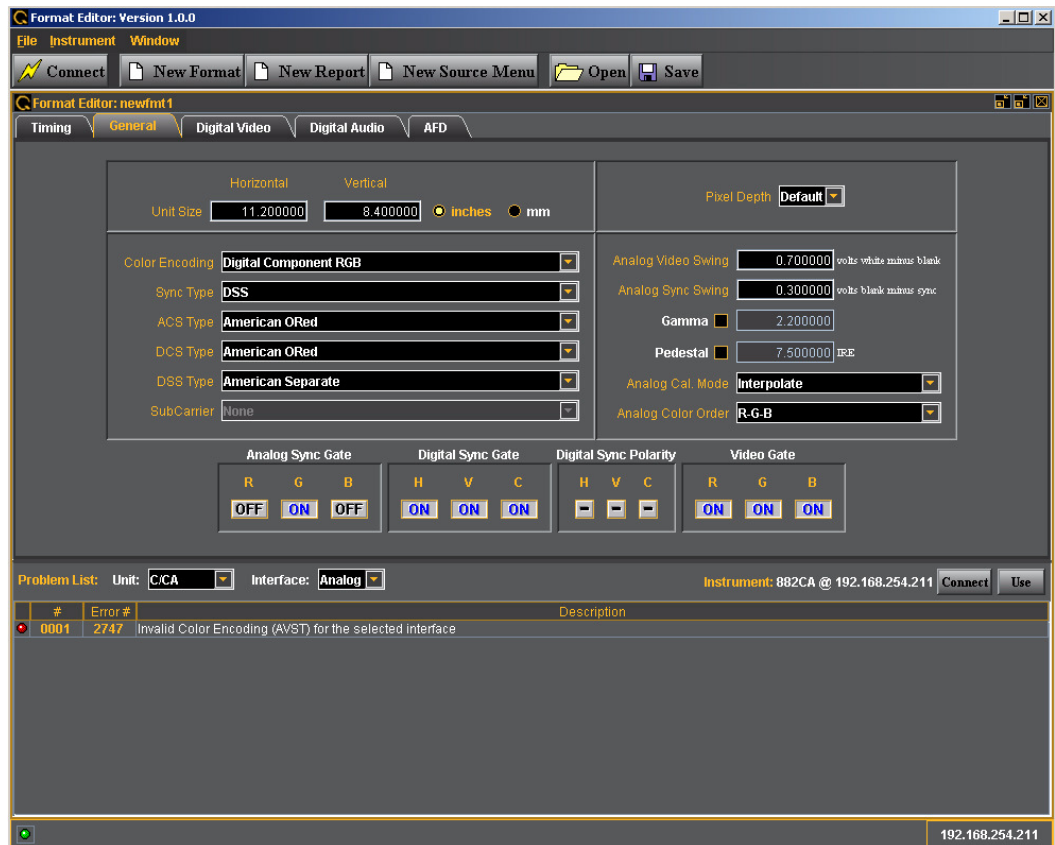

New Format - General Tab (Top Left Panel)

The top left panel of the General tab in the Format Editor is shown below.

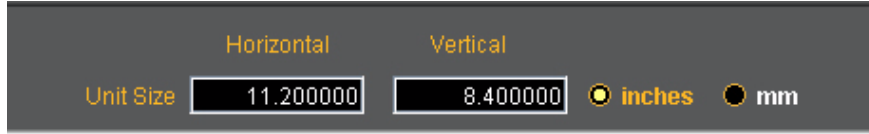

The table that follows describes each of the fields in the top left panel of the General tab.

Field / Entity	Type	Description / Function
Horizontal	Entry field	The horizontal aperture of the display under test.
Vertical	Entry field	The vertical aperture of the display under test.
Unit Size	Radio Buttons:	
	inches	Selects the unit size of the Horizontal and Vertical Size entities to be expressed in inches.
	mm	Selects the unit size of the Horizontal and Vertical Size entities to be expressed in millimeters.

New Format - General Tab (Top Right Panel)

The top right panel of the General tab in the Format Editor is shown below.

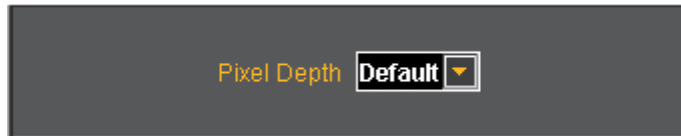

The table that follows describes each of the fields in the top right panel of the General tab.

Field / Entity	Type	Description / Function
Pixel Depth	Pull-down menu	Establishes the number of data bits that represent each active pixel in video memory (frame buffer). Parameter: PELD. There are three settings: Default - uses the generator default 8 - 8 bits-per-pixel (256 colors) 24 - 24 bits-per-pixel (16,777,216 colors)

New Format - General Tab (Center Panel)

The center panel of the General tab in the Format Editor is shown below.

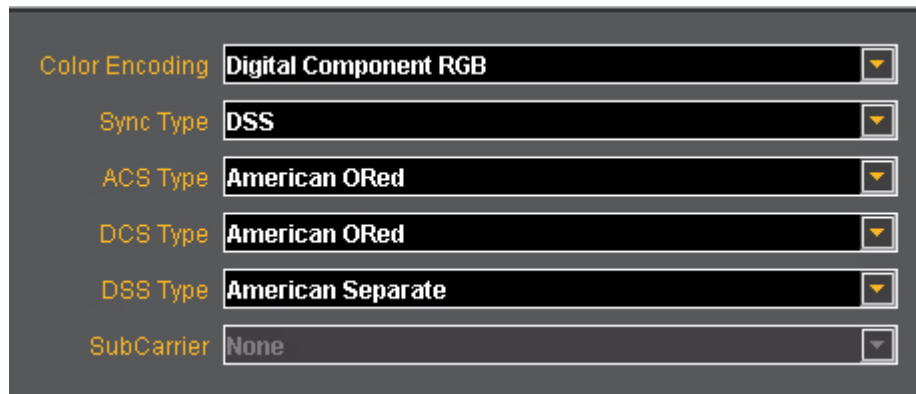

The image shows a dark gray panel with six dropdown menus. Each menu has a label on the left and a value in the center, with a small downward arrow on the right. The labels are in a light orange color, and the values are in white.

Color Encoding	Digital Component RGB
Sync Type	DSS
ACS Type	American ORed
DCS Type	American ORed
DSS Type	American Separate
SubCarrier	None

The table below describes the pull-down menus in the center panel of the General tab.

Field / Entity	Description / Function
Color Encoding	<p>Sets the colorimetry of the format. The parameter is AVST or DVST. The following are the selections:</p> <ul style="list-style-type: none"> • Default • Analog Grayscale YYY • Analog Component RGB • Analog Composite with Color Kill • Analog Composite with Subcarrier • Analog Component YPbPr SDTV • Analog Component YPbPr HDTV Legacy • Analog Component YPbPr HDTV Modern • Analog Component YPbPr Betacam • Analog Component Monochrome • Digital Direct VI MDA • Digital Direct RGB • Digital Direct RGBI CGA • Digital Direct RrGgBb EGA • Digital Component YYY • Digital Component RGB • Digital Component YCbCr SDTV (ITU-R BT.601-5) • Digital Component YCbCr HDTV Legacy (SMPTE 240M) • Digital Component YCbCr HDTV Modern (ITU-R BT.709-5) • Digital BT.601 xvYCC • Digital BT.709 xvYCC
Sync Type	<p>Sets the sync type of the format. The parameter is SSST. The following are the selections:</p> <ul style="list-style-type: none"> • (0) None • (1) DSS - Digital Separate Sync • (2) DCS - Digital Composite Sync • (3) ACS - Analog Composite Sync • (4) ACS, DSS - Analog Composite Sync, Digital Separate Sync • (5) ACS, DCS - Analog Composite Sync, Digital Composite Sync • (6) ACS, DCS, DSS - Analog Composite Sync, Digital Composite Sync and Digital Separate Sync • (7) DPMS OFF • (8) DPMS Suspend • (9) DPMS Standby • (10) DPMS ON

Field / Entity	Description / Function
ACS Type	<p>Sets the analog composite sync type of the format. The parameter is ASCT. The following are the selections:</p> <ul style="list-style-type: none"> • None • American ORed • American Single Serrated • American Double Serrated (ref SMPTE 170M NTSC) • Australian AS 493.1-200X CS Serrated • European ORed • European Double Serrated (ref ITU-R BT.470-6 PAL) • SMPTE 296M-EIA/CEA • HDTV Double Serrated (ref SMPTE 296M) • SMPTE 295M-EIA/CA • HDTV Double Serrated (ref SMPTE 295M) • SMPTE 274M-EIA/CA • HDTV Double Serrated (ref SMPTE 240M, 260M, 274M)
DCS Type	<p>Sets the digital composite sync type of the format. The parameter is DSCT. The following are the selections:</p> <ul style="list-style-type: none"> • None • American ORed • American Single Serrated • American Double Serrated (ref SMPTE 170M NTSC) • Australian AS 493.1-200X CS Serrated • European ORed • European Double Serrated (ref ITU-R BT.470-6 PAL)

Field / Entity	Description / Function
DSS Type	<p>Sets the digital composite sync type of the format. The parameter is DSST. The following are the selections:</p> <ul style="list-style-type: none"> • None • American Separate • European Separate • American Separate HDTV • European Separate HDTV • Japanese Separate HDTV • Australian AS 493.1-200X HS & VS • IEC 62315-1 Australian AS 493.1-200X HS & VS
SubCarrier	<p>Sets the composite video subcarrier type. Only valid when the color encoding parameter (AVST) is set to Analog Composite with Subcarrier. The parameter is AVSC. The following are the selections:</p> <ul style="list-style-type: none"> • None • NTSC M • NTSC 443 • PAL BDGHI • PAL NC • PAL N • PAL M • PAL 60

New Format - General Tab (Right Panel)

The right panel of the General tab in the Format Editor is shown below.

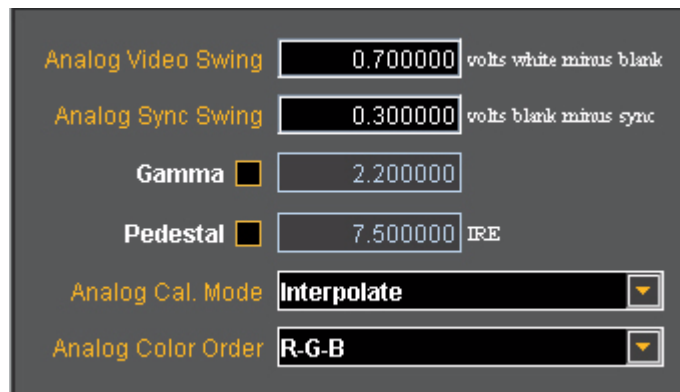

The table below describes the entities and fields of the right-side panel of the General tab.

Field / Entity	Entity Type	Description / Function
Analog Video Swing	Entry field	Sets the analog video swing.
Analog Sync Swing	Entry field	Sets the analog sync swing.

Field / Entity	Entity Type	Description / Function
Gamma	Check box	Enables or disables Gamma. Used with the entry field below. Parameter: GAMC.
	Entry field	Enables you to set the Gamma once the Gamma check box above is enabled (checked). The allowable ranges of values is 0.1 to 10.0. Parameter: GAMA.
Pedestal	Check box	Enables or disables the Pedestal. Used with the entry field below. Pedestal is only supported on NTSC format types. Parameter: AVPG.
	Entry field	Enables you to set the Pedestal once the Pedestal check box above is enabled (checked). The allowable ranges of values is 0 IRE to 100 IRE. Parameter: AVPS.
Analog Cal. Mode	Pull-down select	Sets the analog calibration mode. Determines how the generator tests and calibrates its analog video outputs Parameter: AVCM. The following are the selections: <ul style="list-style-type: none"> • Interpolate • Measure Interpolate • Measure Set Absolute • Test Levels
Analog Color Order	Pull-down select	Sets the mapping of the analog video colors to the video output connections. Parameter: AVCO. The following are the selections: <ul style="list-style-type: none"> • RGB - R to R, G to G, B to B (default) • RBG - R to R, B to G, G to B • GRB - G to R, R to G, B to B • GBR - G to R, B to G, G to B • BRG - B to R, R to G, G to B • BGR - B to R, G to G, R to B

New Format - General Tab (Bottom Panel)

The bottom panel of the General tab in the Format Editor is shown below.

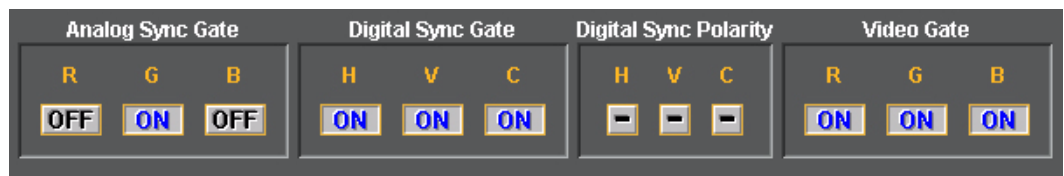

The table below describes the gating functions of the right-side panel of the General tab.

Field / Entity	Entity Type	Description / Function
Analog Sync Gate	Select buttons	<p>Enables you to put the analog composite sync on one of the components when analog composite sync is selected as the sync type using the SSST command. Multiple selections can be made.</p> <p>R Puts the analog composite sync on the Red component. Parameter: ASSG.</p> <p>G Puts the analog composite sync on the Green component. Parameter: ASSG.</p> <p>B Puts the analog composite sync on the Blue component. Parameter: ASSG.</p>
Digital Sync Gate	Select buttons	<p>H Enables and disables the digital horizontal sync output. To use digital horizontal sync, the digital separate H and V sync must be selected with the SSST command. Parameter: HSPG.</p> <p>V Enables and disables the digital vertical sync output. To use digital vertical sync, the digital separate H and V sync must be selected with the SSST command. Parameter: VSPG.</p> <p>C Enables and disables the digital vertical sync output. To use digital composite sync, the digital composite sync must be selected with the SSST command. Parameter: CSPG.</p>
Digital Sync Polarity	Select buttons	<p>H Determines whether the digital horizontal sync pulse polarity is positive going or negative going. To set the digital horizontal sync polarity, digital horizontal sync must be gated on with the HSPG command. Parameter: HSPP.</p> <p>V Determines whether the digital vertical sync pulse polarity is positive going or negative going. To set the digital vertical sync polarity, digital vertical sync must be gated on with the VSPG command. Parameter: VSPP.</p> <p>C Determines whether the digital composite sync pulse polarity is positive going or negative going. To set the digital composite sync polarity, digital composite sync must be gated on with the CSPG command. Parameter: CSPP.</p>
Video Gate	Select buttons	<p>Enables you to gate ON or OFF any of the video components. More than one can be selected.</p> <p>R Gates ON or OFF the Red component/ G Gates ON or OFF the Green component/ B Gates ON or OFF the Blue component/</p>

New Format - Digital Video Tab

The Format Editor Digital Video tab is shown below.

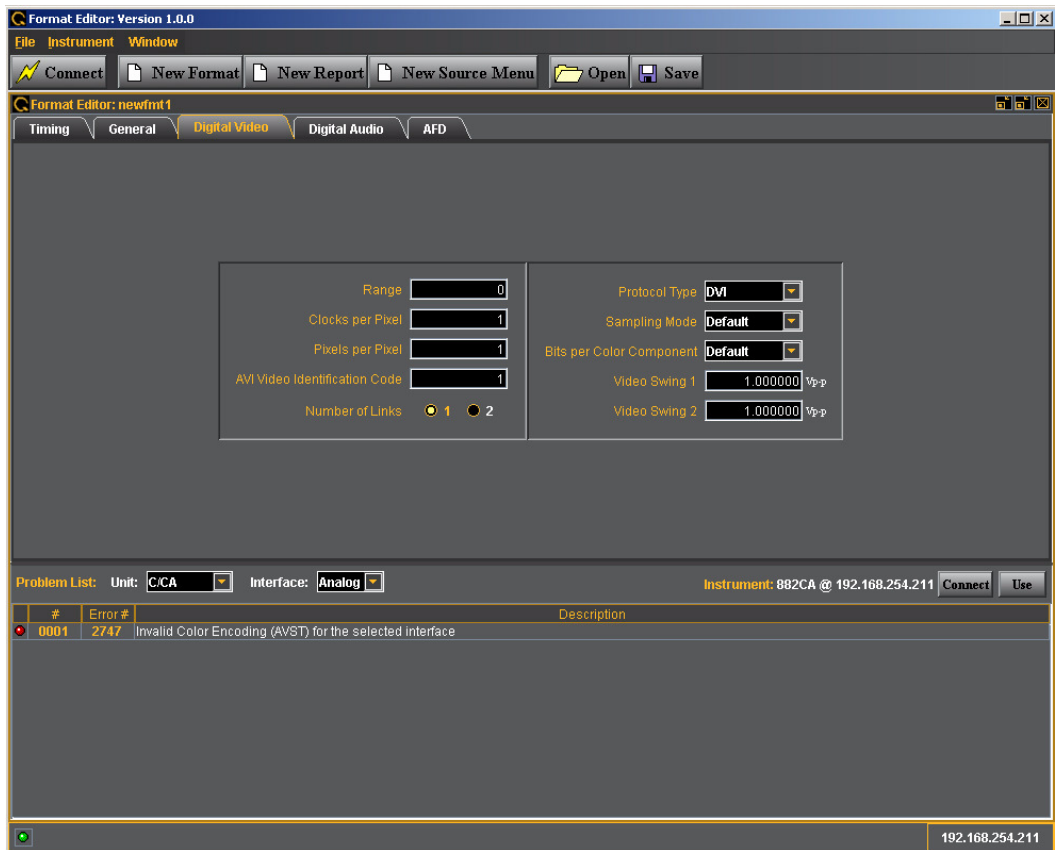

The table that follows describes each of the fields in the Digital Video tab.

Entity / Field	Type	Description / Function
Range	Entry field	
Clocks per Pixel	Entry field	Specifies the number of clocks per pixel (double clocking factor for whole line. This parameter is used to boost the clock rate to the minimum supported by TMDS interface. Allowable values are: <ul style="list-style-type: none"> • 1 - one clock per pixel • 2 - two clocks per pixel Parameter: NCPP.
Pixels per Pixel	Entry field	Specifies the number of pixels per pixel. This parameter specifies the pixel repetition factor for the active portion of the line. Allowable values are: <ul style="list-style-type: none"> • 0 - disables repetition mode • 1 to 10 - enables pixel repetition (inserts extra left and right pixel repetition bars) Parameter: NPPP.

Entity / Field	Type	Description / Function
AVI Video Identification Code	Entry field	The digital video code corresponding to the EIA/CEA-861 standard. Parameter: DVIC.
Number of Links	Radio button	<p>1 Sets the number of links to 1 by the DVI output.</p> <p>2 Sets the number of links to 2 for the DVI output</p> <p>Parameter: NLNK</p>
Protocol Type	Pull-down select	<p>Specifies which digital output is active through the HDMI interface. Allowable values are:</p> <ul style="list-style-type: none"> DVI - Enables DVI mode out the DVI output or the HDMI output. HDMI - Enables HDMI mode out the HDMI output. <p>Parameter: XVSI</p>
Sampling Mode	Pull-down select	<p>Specifies the digital sampling mode. Allowable values are:</p> <ul style="list-style-type: none"> Default - RGB 4:4:4. 4:2:2 - Color difference components are sampled at half the pixel rate. Luminance is sampled at the full pixel rate. Requires that the YCbCr color mode be selected with the DVST command. 4:4:4 - Color difference components and luminance component is sampled at the full pixel rate. Requires that the YCbCr color mode be selected with the DVST command. <p>Parameter: DVSM</p>
Bits per Color Component	Pull-down select	<p>Specifies the number of bits per component. Allowable values are:</p> <ul style="list-style-type: none"> Default - Use the default setting in the generator. 6 - Six bits per component. 8 - Eight bits per component. 10 - Ten bits per component. 12 - Twelve bits per component. <p>Parameter: NBPC</p>
Video Swing 1	Entry field	<p>Sets the digital video voltage swing for the HDMI output 1. The range of values is: 0.150 to 1.560</p> <p>Parameter is: DVSS</p>
Video Swing 2	Entry field	<p>Sets the digital video voltage swing for the HDMI output 2. The range of values is: 0.150 to 1.560</p> <p>Parameter is: DVSS</p>

New Format - Digital Audio Tab

The Format Editor Digital Audio tab is shown below. The table that follows describes each of the fields in the tab.

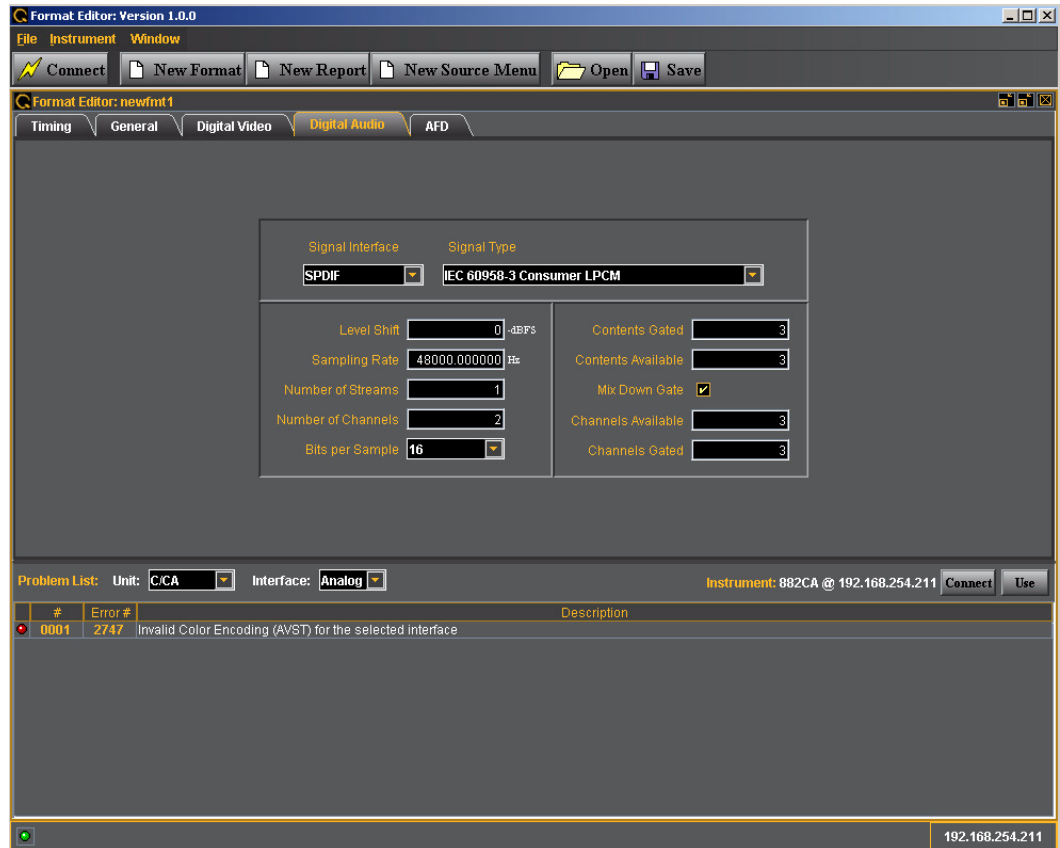

The table below describes each of the fields in the Digital Audio tab.

Field	Type	Description / Function
Signal Interface	Pull-down select	<p>Sets the digital audio signal interface. The valid values are:</p> <ul style="list-style-type: none"> • None - Use HDMI. • SPDIF. • AES3 (not used). • AESid (not used). • TOSlink optical (not used). • MiniPlug (not used). <p>Parameter is: DASI.</p>
Signal Type	Pull-down select	<p>Sets the digital audio signal type. The valid values are:</p> <ul style="list-style-type: none"> • None • IEC 60958-3 Consumer LPCM. • IEC 60958-4 Professional LPCM. • IEC 61937 w/AC-3 (Dolby Digital). • MP2 (Video CD) (not used). • MP3 (MPEG1 Layer 3) (not used). • MPEG2 5.1 channels Advanced Audio Coding (AAC) • MPEG2 7.1 channel CBR or VBR • IEC 61937 w/DTS • ATRAC <p>Parameter is: DAST.</p>
Level Shift	Entry field	<p>Sets the digital audio level shift value. The valid values are: 0 - 15 dBFS.</p> <p>Parameter is: DALS.</p>
Sampling Rate	Entry field	<p>Sets the digital audio sampling rate. The valid values are:</p> <ul style="list-style-type: none"> • 32.0kHz • 44.1kHz • 48.0kHz • 88.2kHz • 96.0kHz • 176.4kHz • 192.0kHz <p>Parameter is: ARAT.</p>
Number of Streams	Entry field	<p>Sets the digital audio streams. The valid value is: 1.</p> <p>Parameter is: NDAS.</p>
Number of Channels	Entry field	<p>Sets the digital audio sampling rate. The valid values are: 2 through 8</p> <p>Parameter is: NDAC.</p>

Field	Type	Description / Function
Bits per Sample	Pull-down select	<p>Sets the digital audio sampling rate. The valid values are:</p> <ul style="list-style-type: none"> • 16 • 20 • 24 <p>Parameter is: NBPA.</p>
Contents Gated	Entry field	<p>Sets the digital audio content gate. The valid values are: 0 through 4095. Refer to EIA/CEA-861-x.</p> <p>Parameter is: DAXG.</p>
Contents Available	Entry field	<p>Sets the digital audio content available. The valid values are: 0 through 4095. Refer to EIA/CEA-861-x.</p> <p>Parameter is: DAXA.</p>
Mix Down Gate	Check box	<p>Sets the digital audio down-mix gate. The valid values are: enabled or disabled.</p> <p>Parameter is: DADG.</p>
Channels Available	Entry field	<p>Sets the digital audio channels available. The valid values are: 0 through 255. Refer to EIA/CEA-861-x.</p> <p>Parameter is: DACA.</p>
Channels Gated	Entry field	<p>Sets the digital audio channel gate. The valid values are: 0 through 255. Refer to EIA/CEA-861-x.</p> <p>Parameter is: DACG.</p>

New Format - AFD Tab

The Format Editor AFD tab is shown below. The table that follows describes each of the fields in the tab.

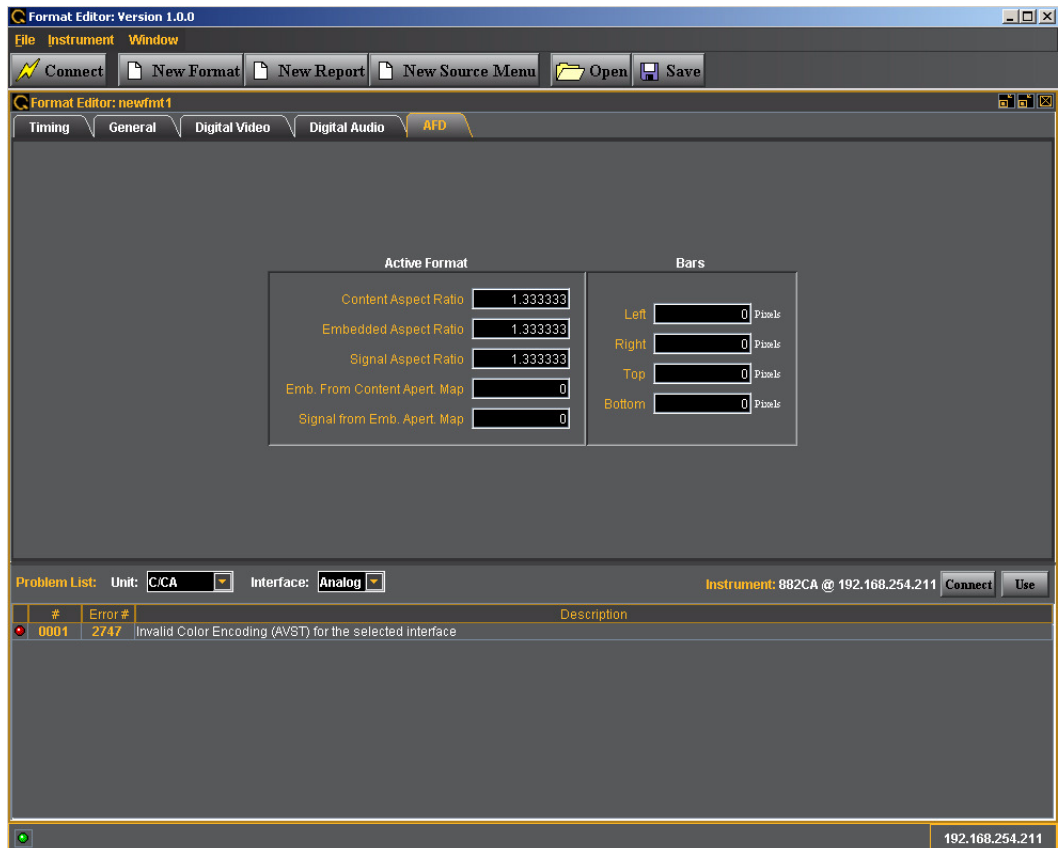

The table that follows describes each of the text entry fields in the AFD tab.

Heading	Field	Description / Function
Active Format		
Content Aspect Ratio		Sets the aspect ratio of the source image content. The valid parameter range is: 0.75 to 2.39. Parameter: CXAR.
Embedded Aspect Ratio		Sets the aspect ratio of the extended image content. The valid parameter range is: 0.75 to 2.39. Parameter: EXAR.
Signal Aspect Ratio		Sets the aspect ratio of the video signal image content. The valid parameter range is: 0.75 to 2.39. Parameter: SXAR.

Heading	Field	Description / Function
	Extended From Content Apert. Map	Enables you to set the mapping type for mapping CXAR-shaped image content into the extended EXAR-shaped aperture. Parameter: EXCX
	Signal from Extended Apert. Map	Enables you to set the mapping type for mapping EXAR-shaped image content into the SXAR-shaped signal interface. Parameter: SXEX
Bars	Left	Sets the left side letterbox bars in pixels.
	Right	Sets the right side letterbox bars in pixels.
	Top	Sets the top letterbox bars in pixels.
	Bottom	Sets the bottom letterbox bars in pixels.

Format Editor - New Report

This subsection defines the New Report screen. The contents of the New Report tab is shown below.

The screenshot shows the 'Format Editor: Version 1.0.0' application window. The 'New Report' tab is active, displaying a table of video format specifications. The table columns include Name, Digital Video Identification Code, Horizontal Total, Horizontal Active, Horizontal Sync Pulse Polarity, Horizontal Rate (KHz), Vertical Total, Vertical Active, Vertical Sync Pulse Polarity, Vertical Rate, and Scan Type. The table lists various formats such as 1035i29.xml, 1035i30.xml, 1080i25.xml, 1080i29.xml, 1080i30.xml, 1080i50.xml, 1080i59.xml, 1080i60.xml, 1080p100.xml, 1080p119.xml, 1080p120.xml, 1080p23.xml, 1080p24.xml, 1080p25.xml, 1080p29.xml, 1080p30.xml, 1080p50.xml, 1080p59.xml, 1080p60.xml, 1080s23.xml, 1080s24.xml, 1080i25_.xml, 1152LA.xml, 1152LH.xml, and 1152LH_.xml. The status bar at the bottom indicates 'Table OK completed' and the instrument address '192.168.254.211'.

Name	Digital Video Identification Code	Horizontal Total	Horizontal Active	Horizontal Sync Pulse Polarity	Horizontal Rate (KHz)	Vertical Total	Vertical Active	Vertical Sync Pulse Polarity	Vertical Rate	Scan Type
1035i29.xml	0	2200	1920	+	33.71630	1125	1035	+	59.9401	Interlace
1035i30.xml	0	2200	1920	+	33.75000	1125	1035	+	60.0	Interlace
1080i25.xml	20	2640	1920	+	28.12500	1125	1080	+	50.0	Interlace
1080i29.xml	5	2200	1920	+	33.78380	1125	1080	+	60.06	Interlace
1080i30.xml	5	2200	1920	+	33.75000	1125	1080	+	60.0	Interlace
1080i50.xml	40	2640	1920	+	56.25000	1125	1080	+	100.0	Interlace
1080i59.xml	46	2200	1920	+	67.43260	1125	1080	+	119.8801	Interlace
1080i60.xml	46	2200	1920	+	67.50000	1125	1080	+	120.0	Interlace
1080p100.xml	64	2640	1920	+	112.50000	1125	1080	+	100.0	Progressive
1080p119.xml	63	2200	1920	+	134.86510	1125	1080	+	119.8801	Progressive
1080p120.xml	63	2200	1920	+	135.00000	1125	1080	+	120.0	Progressive
1080p23.xml	32	2750	1920	+	26.97300	1125	1080	+	23.976	Progressive
1080p24.xml	32	2750	1920	+	27.00000	1125	1080	+	24.0	Progressive
1080p25.xml	33	2640	1920	+	28.12500	1125	1080	+	25.0	Progressive
1080p29.xml	34	2200	1920	+	33.71630	1125	1080	+	29.97	Progressive
1080p30.xml	34	2200	1920	+	33.75000	1125	1080	+	30.0	Progressive
1080p50.xml	31	2640	1920	+	56.25000	1125	1080	+	50.0	Progressive
1080p59.xml	16	2200	1920	+	67.43260	1125	1080	+	59.9401	Progressive
1080p60.xml	16	2200	1920	+	67.50000	1125	1080	+	60.0	Progressive
1080s23.xml	0	2750	1920	+	26.97300	1125	1080	+	47.952	Interlace
1080s24.xml	0	2750	1920	+	27.00000	1125	1080	+	48.0	Interlace
1080i25_.xml	39	2304	1920	+	31.25000	1250	1080	-	50.0	Interlace
1152LA.xml	0	1152	960	+	31.25000	1250	1152	+	50.0	Interlace
1152LH.xml	0	1188	960	+	31.25000	1250	1152	+	50.0	Interlace
1152LH_.xml	0	2304	1920	+	31.25000	1250	1152	-	50.0	Interlace
1152LH_.xml	0	2376	1920	+	31.25000	1250	1152	-	50.0	Interlace

Source Path: \\ffs0\Library\Formats

Table OK completed

192.168.254.211

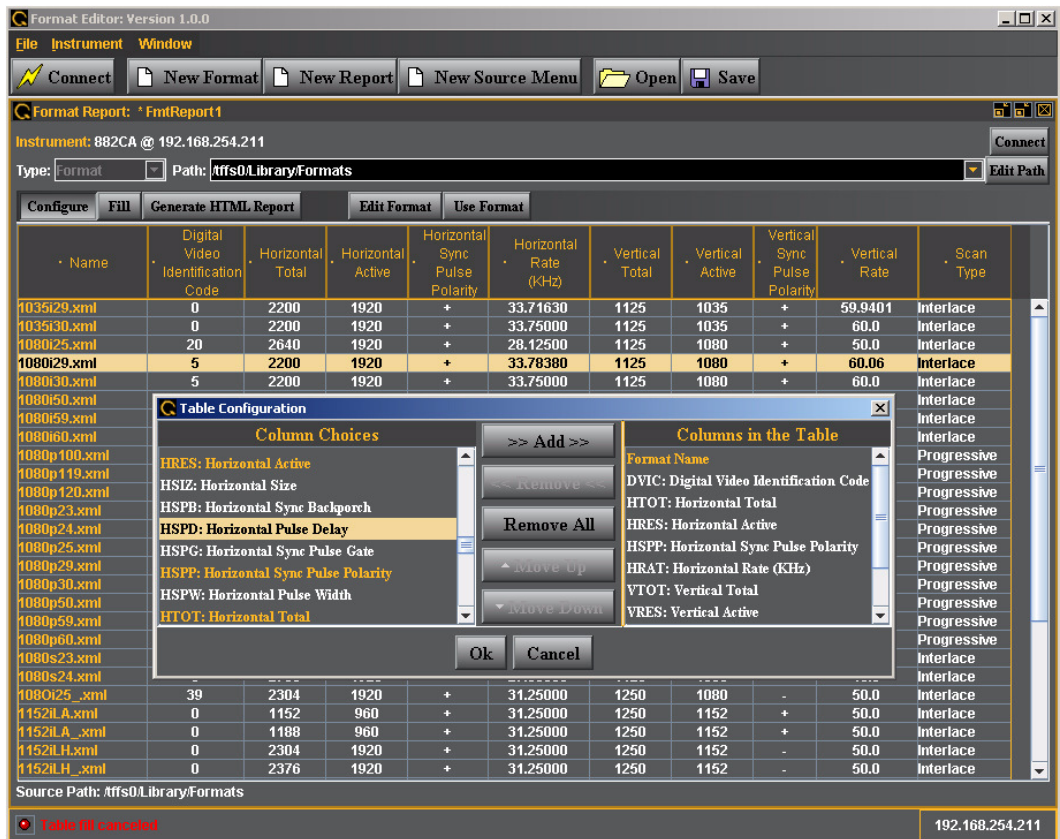

The table below describes the top selection panels for the New Report activation button

Entity	Type	Description / Function
Instrument (Connection Status)	Status text field	Shows the current connection status.
Connect	Activation Button	Enables you to connect to an 882 generator. When clicked a dialog box will pop up enabling you to specify an IP address to connect to.
Type	Pull-down menu	Always set to Format.
Path	Entry Field	The path to the directory where the list of formats used to configure a format list.
Edit Path	Activation Button	Enables you to change the path to a list of formats.

The table below describes the activation buttons available for the New Report screen.

Button	Description / Function
Configure	Clicking on the Configure button will open up a dialog box that enables you to configure which format parameters appear in the report and in what order.
Fill / Cancel	Clicking on the Fill activation button will cause the Format Editor application to begin loading the formats from the list that the Path is set to. The completion status is shown below the list. The Cancel button on the lower right enables you to halt the filling (reading) of the formats from the list in the directory that the path parameter is set to.

Button	Description / Function
Generate HTML Report	Clicking on this button will cause the Format Editor application to generate an HTML report of the list of formats. A dialog box pops up to allow you to specify a location and name on your PC.
Edit Format	This activation button is only enabled when you select a format from the list. Clicking on this button will open up the Format Editor window at the Timing tab.
Use Format	This activation button is only enabled when you select a format from the list. Clicking on this button activate this format in the connected 882 generator.

The table below describes the report fields available for the New Report screen.

Report Parameter	Parameter Description
Name	The format name.
Digital Video Identification Code	Writes the specified Video Identification Code (VIC) into the AVI InfoFrame.
Horizontal Total	The total number of active pixels (Machine) or microseconds (Time) of the horizontal video. The total is the sum of the Active and Blanking. Parameter: HTOT.
Horizontal Active	The number of active pixels (machine) or microseconds (Time) of the horizontal video. Parameter: HRES.
Horizontal Sync Pulse Polarity	Indicates whether the digital horizontal sync pulse polarity is positive going or negative going. Parameter: HSPP.
Horizontal Rate (kHz)	The horizontal line rate of the format. The HRAT is the fundamental frequency in the 882. Parameter: HRAT.
Vertical Total	The total number of active lines (Machine) or milliseconds (Time) of the vertical video. The total is the sum of the Active and Blanking. Parameter: VTOT.
Vertical Active	The number of active lines (machine) or milliseconds (Time) of the vertical video. Parameter: VRES.
Vertical Sync Pulse Polarity	Indicates whether the vertical sync pulse polarity is positive or negative going. Parameter: VSPP.
Vertical Rate	The vertical frame rate of the format. Parameter: VRAT.
Sync Type	Indicates the sync type of the format. The parameter is SSST.

The screen below shows the Format Table Configuration Screen. This screen enables you to configure the fields for the format report.

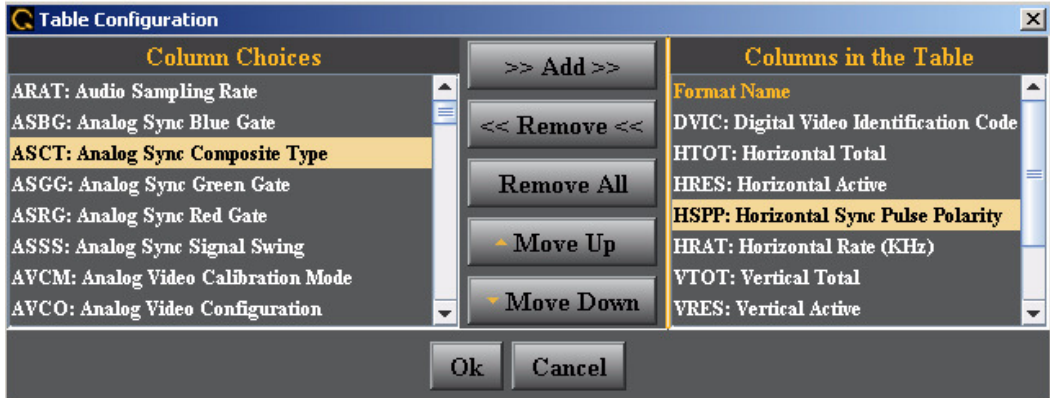

The table below describes the fields and buttons for the Table Configuration Screen.

Entity	Description / Function	
Column Choices	Configuration Field	Provides a list of format parameters to select and move to the report.
Column in the Table	Configuration Field	Shows the current list of format parameters that will appear in the report. The format parameters will appear in the order (top to bottom / left to right) in the report.
Add	Activation Button	Enables you to move format parameters from the Column Choices to the Columns in the Table (that will appear in the reports).
Remove	Activation Button	Enables you to remove format parameters from the Columns that will appear in the table.
Remove All	Activation Button	Enables you to remove all the format parameters currently shown in the Column in the Table field.
Move Up	Activation Button	Enables you to change the order (move up) the selected format parameters in the Columns in Table that will appear in the format report. The top most parameters will appear in the left most side of the report.
Move Down	Activation Button	Enables you to change the order (move down) the selected format parameters in the Columns in Table that will appear in the format report. The top most parameters will appear in the left most side of the report.

Format Editor - New Source Menu

This subsection defines the New Source Menu dialog box. The New Source Menu dialog box is shown below:

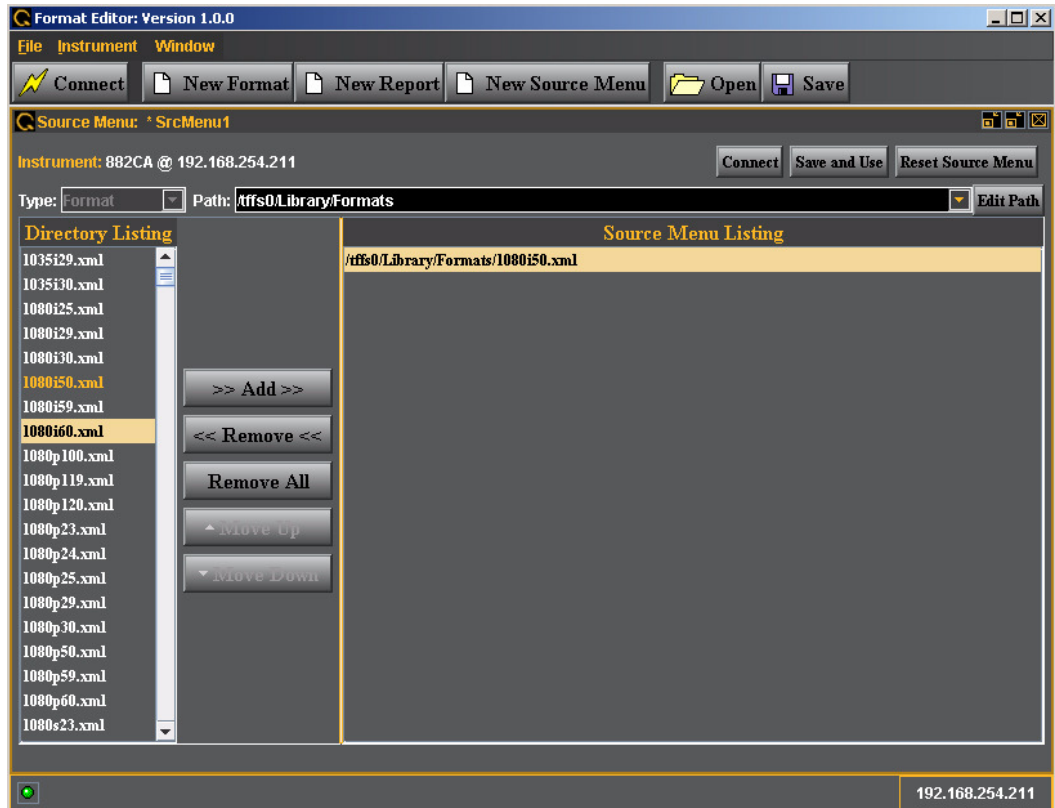

The table below describes the top panels fields, activation buttons and pull down menus.

Entity	Type	Description / Function
Instrument (Connection Status)	Status text field	Shows the current connection status.
Connect	Activation Button	Enables you to connect to an 882 generator. When clicked a dialog box will pop up enabling you to specify an IP address to connect to.
Save and Use	Activation Button	Enables you to save the format source list to the generator you are connected to and then apply this list to the current generator configuration.
Reset Source Menu	Activation Button	
Type	Pull-down menu	Always set to Format.
Path	Entry Field	The path to the directory where the list of formats used to configure a source list.
Edit Path	Activation Button	Enables you to change the path to a list of formats.

The table below describes the main panels fields, of the New Source Menu.

Entity	Type	Description / Function
Directory Listing	Configuration Field	Provides a list of formats to select and move to a particular (set by the Path entry field) directory on the 882 generator.
Source Menu Listing	Configuration Field	Shows the current list of formats that will appear in a particular directory (set by the Path entry field) on the 882 generator.
Add	Activation Button	Enables you to move formats from the Directory Listings to the Source Menu Listing fields (formats that will appear a particular format directory i.e. set by the Path entry field).
Remove	Activation Button	Enables you to remove formats from the Source Menu Listing fields so that they will not appear in a particular format directory (set by the Path entry field).
Remove All	Activation Button	Enables you to remove all the formats currently shown in the Source Menu Listing field.
Move Up	Activation Button	Enables you to change the order (move up) the selected formats in the Source Menu Listing field that will appear in a particular format directory (set by the Path entry field). The top most formats will appear first in the list.
Move Down	Activation Button	Enables you to change the order (move down) the selected formats in the Source Menu Listing field that will appear in a particular format directory (set by the Path entry field). The top most formats will appear first in the list.

Format Editor - Open

This subsection defines the Open [File] dialog box. The Open dialog box is shown below. This enables you to open an existing format file either from your PC (**Local** tab) or from the 882 instrument (**Remote** tab).

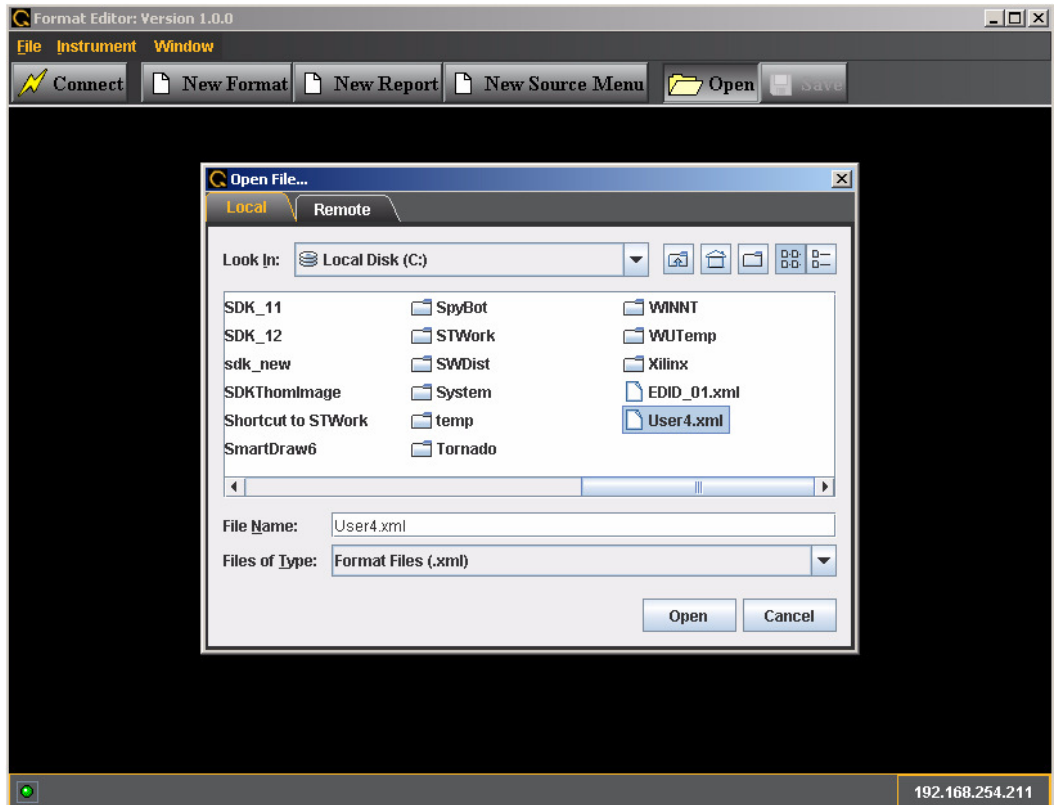

Format Editor - Save

This subsection defines the Save [File] dialog box. The Save dialog box is shown below. You use the Save function to store a format that you have defined. You can either save it to your PC (**Local** tab) or the 882 instrument (**Remote** tab).

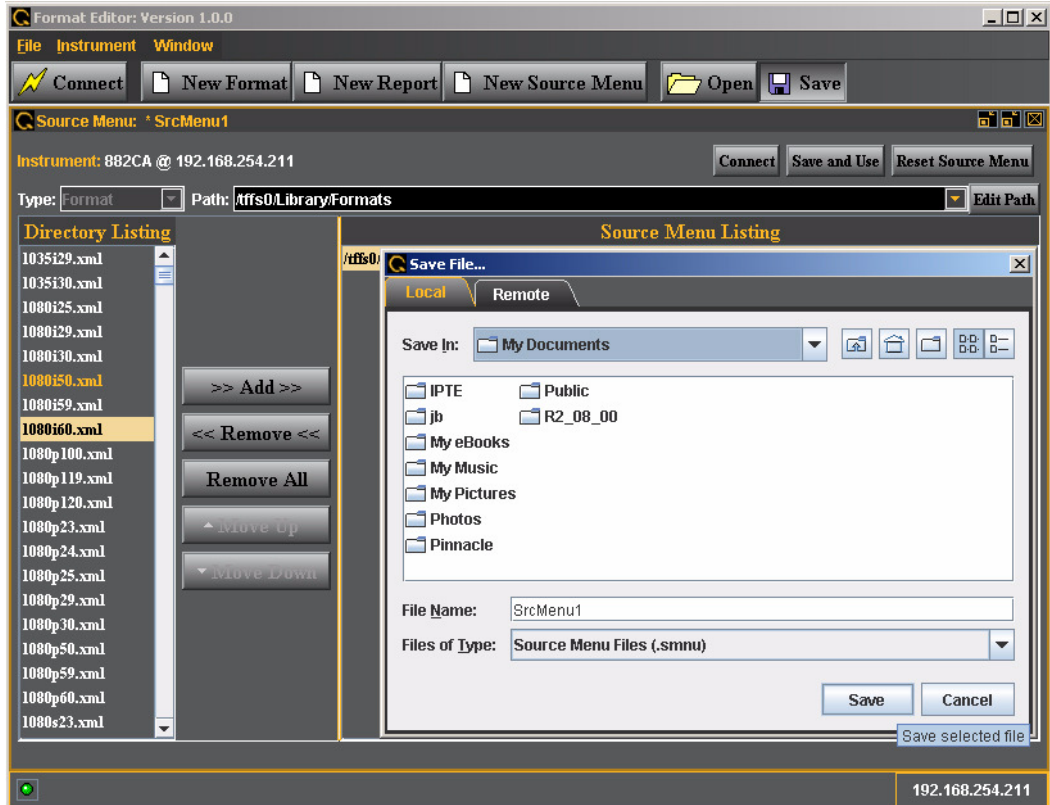

Creating a new format using the Format Editor

The procedure below describes how to create a new format using the Format Editor.

To create a new format using the Format Editor:

1. Open a Web browser (such as Internet Explorer) and type the generator's IP address in the address entry field. For example, enter the following: `http://206.135.215.189/`

The generator home page appears in the browser.



Java is a trademark of Sun Microsystems, Inc.

Note: You can add the page to your list of favorite pages in your Web browser to avoid retyping the IP address each time you want to access the page.

2. Select **Format Editor**. The Format Editor appears.

- Click **New Format**. The Timing tab of the format definition page appears as shown below.

The screenshot shows the 'Format Editor: Version 1.0.0' application window. The 'Timing' tab is active, displaying various parameters for a video format. The 'Pixel Rate' is set to 25,200,000 Mbits. The 'Horizontal' section shows a Rate of 31,500,000 KHz, with Active (640 Pixels), Blank (160 Pixels), and Total (800 Pixels) values. The 'Vertical' section shows a Rate of 60,000,000 Hz, with Active (480 Lines) and Blank (45 Lines) values. A 'Problem List' at the bottom indicates an error: 'Invalid Color Encoding (AVST) for the selected interface'. The interface also includes a 'Scan Type' section with 'Progressive' selected and a 'Repeat Field' checkbox.

Parameter	Value	Unit
Pixel Rate	25,200,000	Mbits
Horizontal Rate	31,500,000	KHz
Horizontal Active	640	Pixels
Horizontal Blank	160	Pixels
Horizontal Total	800	Pixels
Horizontal Pulse Delay	16	Pixels
Horizontal Pulse Width	96	Pixels
Vertical Rate	60,000,000	Hz
Vertical Active	480	Lines
Vertical Blank	45	Lines
Vertical Pulse Delay	10	Lines
Vertical Pulse Width	2	Lines

4. Open an existing file to work from by clicking on the **Open** activation button near the top of the window.

The open file dialog box appears as shown below.

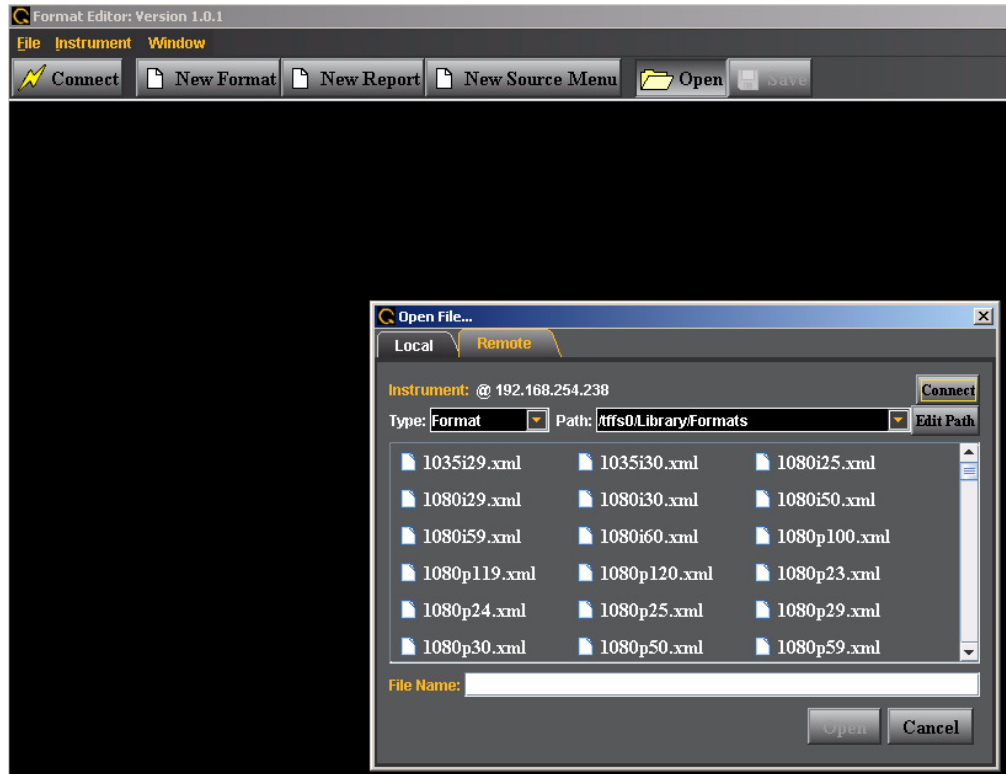

You can either load a file from your PC or from the 882 test instrument by selecting the appropriate tab: 1) **Local** (host PC) or 2) **Remote** (882).

If you are loading a format from the 882 instrument, you will need to make sure that the path is pointing to the directory where the format you wish to use as a base format is stored at. If it is not you will have to edit the path by clicking on the **Edit Path** activation button on the right side of the **Path** field.

5. Navigate and select a format file to use as a starting point for defining your new format or to make simple modifications on an existing format.
6. The format parameters of the selected format will appear in the new format **Timing** window as shown below.
7. Modify the parameters as required for the new format. You can reference the parameter definitions in the subsections above "[Format Editor Overview](#)" on page 184. The following guidelines will help you modify the format parameters.
 - There are parameter values that you may want to change on multiple tabs: 1) Timing "[New Format - Timing Tab](#)" on page 190, 2) General "[New Format - General](#)

Tab” on page 194, 3) Digital Video “New Format - Digital Video Tab” on page 202, 4) Digital Audio “New Format - Digital Audio Tab” on page 204.

- When selecting a parameter to modify on the **Timing** tab, ensure that the value is editable. To be editable, the field either needs to have a pencil icon next to it or a black field background. Gray fields are disabled for editing. Fields in red (with the calculator icon) cannot be modified. However you can change whether a field can be modified by clicking on the calculator icon which will cause it to change to a pencil icon allowing you to change its value.
- Upon modifying a format value hit the enter key to invoke the change. The Format Editor applies the new value to the timing algorithm and updates any values dependent on the value you entered (or changed).

For example, to change the horizontal resolution to 660, enter the value in the **Active** field under Pixels in the Horizontal area.

You will notice that the Format Editor has calculated and written values to the **Blank** and **Period** fields as indicated by the red calculator () symbol. Although the Period value has not changed, the Format Editor still indicates it is a calculated value by displaying the red calculator.

- To apply the format settings on the generator, click the **Use** activation button on the lower right side.

8. Save new format.

- a. Click the **Save** activation button or the select **Save** from the **File** pulldown menu to save the format. The save dialog box appears as shown below.
- a. Enter new format name in **File Path** field.

You can either save it to your PC (**Local** tab) or the 882 instrument (**Remote** tab).

Note: It is recommended that you save custom formats in a directory on the PCard because of file storage limitations in the flash memory.

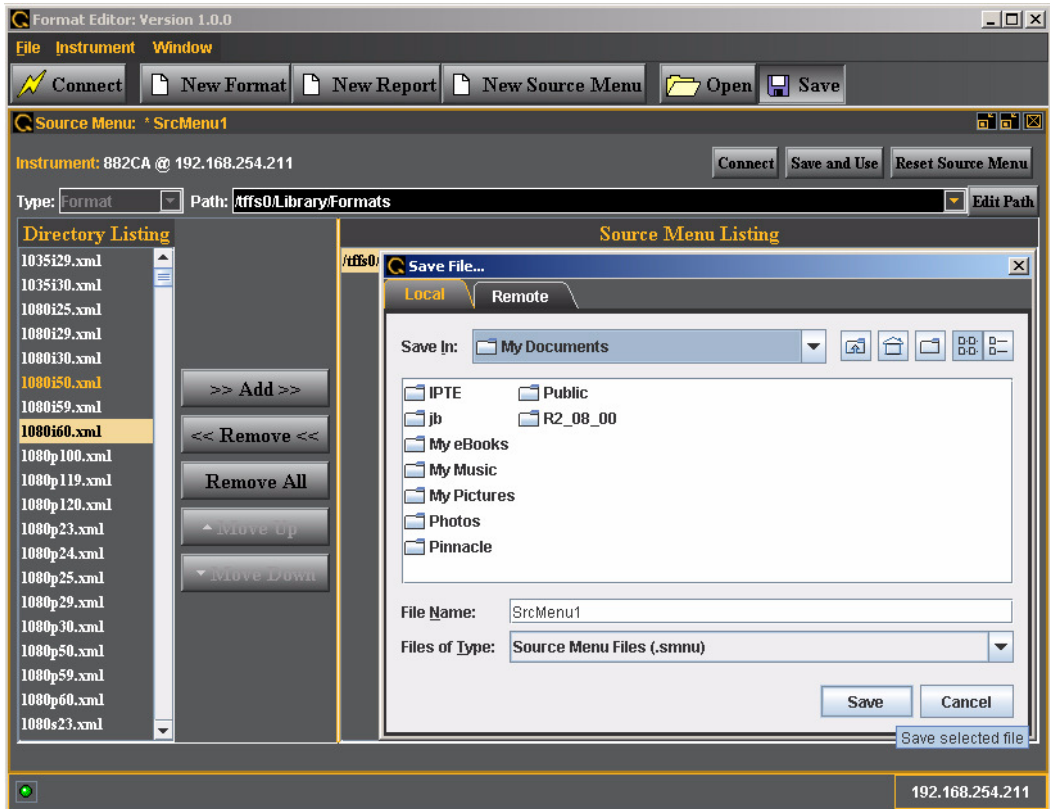

Creating custom formats using the command line interface

There are two methods for creating formats through the command line interface. The first method is to use the FMTN command to set all format parameters in the format buffer to their default values, and then modify each value. The second method is to select an existing format to use as a template for the new format, and then modify only the values needed to create the new format. When using this method, you can save the new format under a new name or the existing name.

Independent of the method you choose, you can enter each command interactively or create a text file containing all the commands you want to issue, and then download the text file to the generator. See “[Configuring the 882's serial port](#)” on page 30 for more information about sending commands to a generator.

The FMTN command is used in creating a new format. This command sets all of the format parameters to known, default values. For a list of the parameters and their default values, see “[FMTN](#)” on page 618. Use the following procedure to create a new format using interactive commands.

To create a new format using the command line interface:

1. Establish a session with the generator using HyperTerminal over a serial connection or Telnet over an Ethernet LAN. For instructions, see “[Establishing a terminal session with the 882](#)” on page 30 and “[Establishing a Telnet session with the 882](#)” on page 33.
2. Set the format path to the medium where you want the new format stored using the following command:

```
FMTF /tffs0/Library/Formats // sets format path to flashmem directory
```

3. Enter the following commands to initialize all parameters to default values and begin a format editing session:

```
FMTN // initializes all parameters to default values
FMTB // begins a format editing session
```

4. Enter the format parameter commands in sequence to set the values for the new format.

```
HRES 654 // sets the horizontal resolution to 654 pixels
.
. // other format parameters
.
HTOT 720 // sets the horizontal total to 720 pixels
```

Note: You do not need to enter a parameter value if it matches the FMTN default setting. You can query a parameter to determine its current value.

5. End the editing session and save the new format using the following commands:

```
FMTE // ends a format editing session
FMFA new_fmt_name // saves format as new specified name
```

Format catalogs

Scrolling through all of the available formats on the Source list can be time consuming. This is particularly true if you regularly use only a few formats that may be scattered throughout the list. You can set up the generator to show only the formats you want, in the order you want, when you browse through the Source list.

The generator's format library is comprised of a set of format catalogs. A format catalog is an XML file that lists related format names. When a catalog is enabled, the format names in the catalog appear on the Source list.

The generator is configured with a default set of catalogs in the Source library. Each catalog represents a set of formats categorized per testing application. You can configure the generator to show only the formats contained in the catalogs you use regularly. Furthermore, you can create your own catalogs and enable them.

With 2.5.x an enhancement has been made to the format catalog function. You can now configure the generator such that your custom formats appear in the Source list along with the 882's default formats. Use the following procedures to create and enable format catalogs.

Using format catalogs

Use the following procedures to enable and disable format catalogs.

To enable catalogs in the Source library using the front panel:

1. Press the **Source** key. The list of formats appears on the generator's display.
2. Press the **Options** key repeatedly until the Library folder appears on the generator's display as shown below:

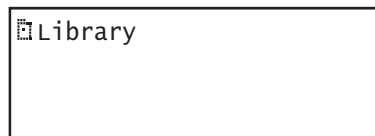

3. Choose the **Library** item by pressing the adjacent soft key. The format library appears as shown below. Each item in the format library is a format catalog.

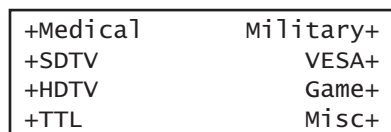

4. Press the soft key adjacent to a catalog to enable or disable it. A + sign next to the item indicates the item is enabled; a - sign indicates it is disabled.

For example, to see only the VESA formats when you press the **Source** key, disable all catalogs except DMT and CVT.

5. Press the **Source** key to see the formats in the selected catalogs.

Creating format catalogs

Use the following procedures to create format catalogs.

To create a new format catalog:

Note: *Format catalogs are created using the command line interface. Although the catalog itself is a file, you will use the Directory (DIR) commands to create the file.*

1. Determine the formats you want to include in your catalog. For example, to create a catalog for testing computer CRTs, you might include the following formats:

```
DMT0660      DMT0659
DMT00675     DMT0685
DMT0856      DMT0860
```

2. Establish a session with the generator using HyperTerminal over a serial connection or Telnet over an Ethernet LAN. For instructions, see “[Establishing a terminal session with the 882](#)” on page 30 and “[Establishing a Telnet session with the 882](#)” on page 33.
3. Verify or set directory path is set to the FormatLib directory using the following command:

```
DIRP?          // to view the current path
or...
DIRP /tffs0/Library/FormatLib // to set the path
```

4. Create the catalog by entering the following commands:

```
DIRN Vesal     // creates a catalog named Vesal
DIRT Source    // identifies new catalog as a source catalog
DIRB           // begins a directory editing session
NAMI 1 /tffs0/Library/Formats/DMT0660 // adds DMT0660 to catalog
.
.              // add other formats
.
NAMI 6 /tffs0/Library/Formats/DMT0860 // adds DMT0860 to catalog
DIRE           // ends the directory editing session
DIRA Vesal     // saves the catalog
DIRL Vesal     // loads the catalog
DIRU           // applies the catalog
```

When you press the **Source** key, the formats in the catalog you created appear in the Source list.

Note: If other catalogs are also selected, the Source list will include the formats in those catalogs as well.

Note: If you power cycle the generator you will have to reinstate the format catalogs by loading with DIRM and using it with DIRU.

To create a format catalog with both custom formats and default formats:

1. Create your custom formats using either the command line “[Creating custom formats using the command line interface](#)” on page 222 or the Format Editor “[Creating custom formats using the Format Editor](#)” on page 186.
2. Set the format path either through the Format Editor or the command line with the FMTMP command “[Setting the 882’s path](#)” on page 17 and shown below:

```
FMTMP /tffs0/library/userdata
```

3. Save the custom format in the directory pointed by the current format path.
4. Enable the User Source library.
 - a. Press the Source key
 - b. Press the Options key repeatedly until the Library listing is shown and select Library.
 - c. Enable the User catalog by pressing the adjacent softkey such that it has a plus (+) sign next to it.

The custom formats that you saved in the Userdata directory will now appear in the Source list with other default formats that have been enabled.

To remove a format from a format catalog:

1. Establish a session with the generator using HyperTerminal over a serial connection or Telnet over an Ethernet LAN. For instructions, see “[Establishing a terminal session with the 882](#)” on page 30 and “[Establishing a Telnet session with the 882](#)” on page 33.
2. Remove a format from a format catalog by entering the following commands:

```
DIRL Vesal          // loads the catalog
DIRT Source
DIRB                // begins a directory editing session
NAMK /tffs0/Library/Formats/DMT0660 // deletes DMT0660
Or...
NAMY 1              // deletes first format in catalog
DIRE                // ends the directory editing session
DIRS                // saves the catalog
DIRU                // applies the catalog
```

Deleting format catalogs

You can delete format catalogs either through the command line or through the FTP Browser. Procedures for both methods are provided below.

To delete a format catalog through the command line:

1. Establish a session with the generator using HyperTerminal over a serial connection or Telnet over an Ethernet LAN. For instructions, see “[Establishing a terminal session with the 882](#)” on page 30 and “[Establishing a Telnet session with the 882](#)” on page 33.

2. Delete a format catalog by entering the following command:

```
DIRK /tffs0/Library/FormatLib/Vesal.xml // deletes catalog named Vesal
```

3. Power cycle the generator.

To delete a format catalog through the Generator FTP Browser:

1. Access the source generator’s Virtual Front Panel. See “[Front panel interface](#)” on page 9.

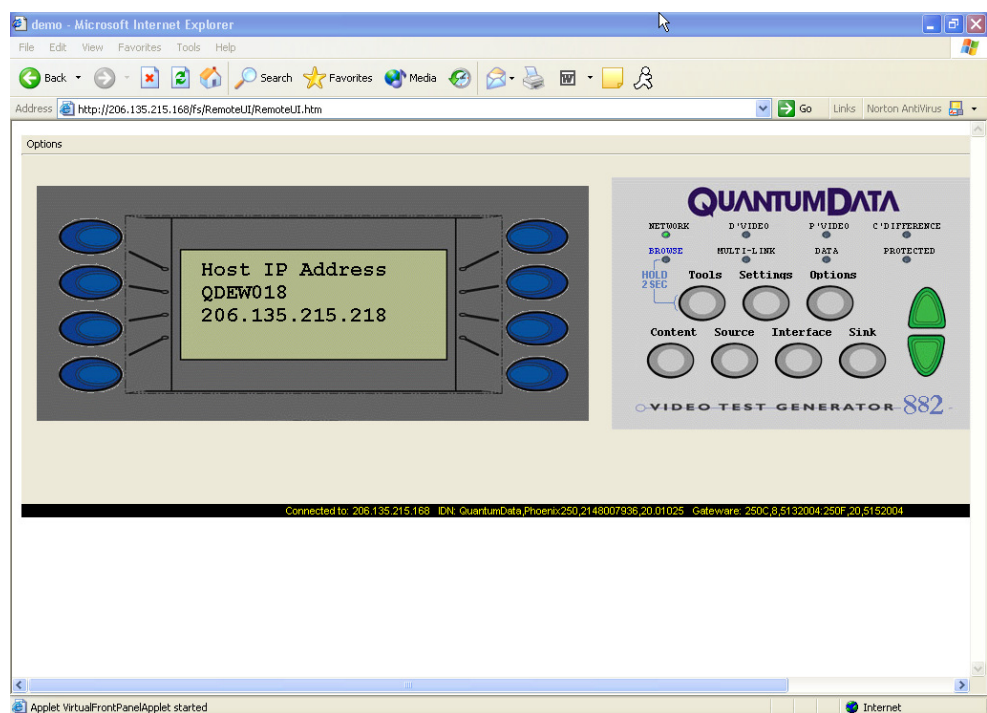

2. From the **Options** menu (upper left corner of the Virtual Front Panel), choose the **FTP Browser** menu item. The Generator FTP Browser appears.
3. In the **Instrument Files** area, click the down arrow and select the **tffs0**. This is the generator’s flash memory.
4. Double click the **Library** folder, and then double-click the **FormatLib** folder to open it.

5. Select the catalog you want to delete.

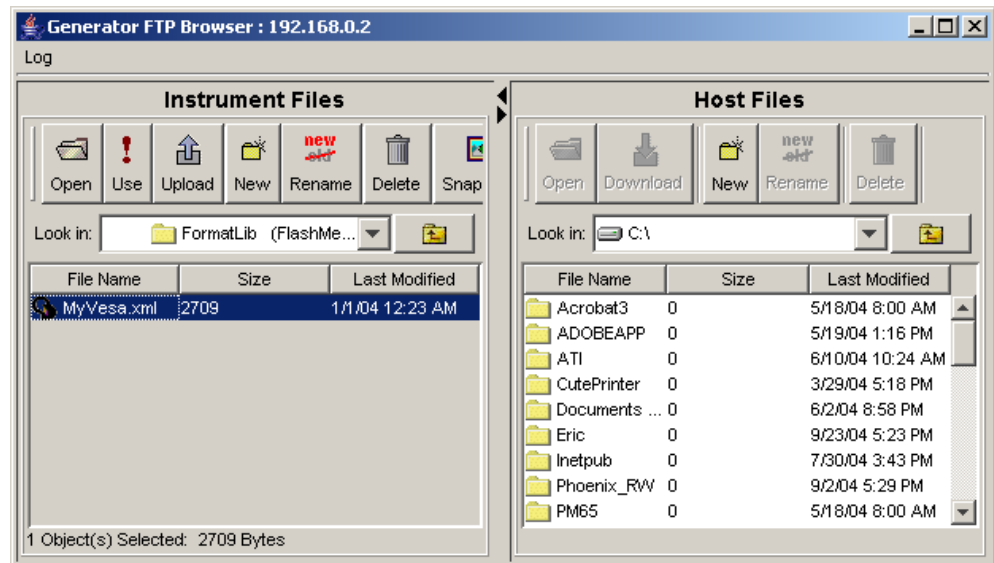

6. Click the **Delete** button to delete the catalog.

7 Working with Images

Topics in this chapter:

- [Overview](#)
- [Viewing the Content list of images](#)
- [Creating custom images](#)
- [Rendering bitmap images](#)
- [Creating image catalogs](#)

Overview

The 882 generator includes a library of 250 test images. The images in the library are compiled in the application and stored as .img files; you cannot modify them.

In addition to the library images there are other types of images that you can create and store on the generator media. You can create your own images either by writing your own code using the generator's Software Development Kit (SDK) or by entering image primitive commands using the command line interface. Furthermore, you can render JPEG images stored on the generator media or a file server PC.

Using the SDK, you can create complex, custom images through the C/C++ API. When you create images through the API, they reside on the generator as object files. You can then render them by selecting the image through the front panel or through the command line interface. When you select one of these images, it gets linked, compiled, and stored in the generator's cache. Please refer to the SDK manual for details on creating custom images using the API.

You can create static images through the command line interface using the image primitive commands, such as RECT (draw rectangle), OVAL (draw oval), Line (draw line), and so on. You can select the grayscale and color tables used in the image and save the images in flash memory. Drawing commands are processed by the generator and stored as XML files. These XML files can be modified if necessary.

JPEG and bitmap images can be stored on any of the generator media and rendered just like any other image type through the **Contents** key.

This chapter provides procedures for viewing lists of images, creating images using the drawing primitive commands, rendering bitmap and jpg images, and creating image catalogs.

Viewing the Content list of images

You can view the list of images available in the generator through the front panel or the command line interface. Use the following procedure to view the image list using the front panel.

Note: The list of images that appears on the generator's display is determined by the image path. In addition, the list may be filtered based on the image catalogs that are enabled. For more information about setting the path, see "[Setting the 882's path](#)" on page 17. For more information about image catalogs, see "[Creating image catalogs](#)" on page 241.

To view the images in the Content list using the front panel:

Press the **Content** key. A list of images appears on the generator's display as shown below. You can scroll through the list using the + and - keys.

Acer1	Acer2
Acer3	Acer4
Acer5	Acer6
Acer7	Acer8

Viewing and modifying image options

Procedures for viewing and modifying the image options through the front panel are provided below.

To view and modify a format's options using the front panel:

1. Press the **Contents** key and choose an image by pressing the adjacent soft key.
 - a. Press the **Options** key. The image options appear on the generator's display as shown below.

-Alternate	Red+
-NoGamma	Green+
-Noise	Blue+

2. Enable or disable the desired option by pressing the adjacent soft key.

Viewing image versions

Many images have secondary or alternate version and some images have many versions. Use the procedures below to view the alternate and multiple image versions.

To view an alternate version for an image in the Content list:

1. Select an image by pressing the **Content** key.
2. Enable and view the alternate image version as follows:
 - a. Press the **Options** key. The following menu appears on the generator's display for images with a single, alternate image:

-Alternate	
	Red+
-NoGamma	Green+
-Noise	Blue+

- b. Choose the **Alternate** item by pressing the adjacent soft key until a + appears next to the item.

+Alternate	
	Red+
-NoGamma	Green+
-Noise	Blue+

3. Toggle back and forth between the images by pressing the soft key adjacent to Alternate.

To view multiple image versions in the Content list:

1. Select an image by pressing the **Content** key.
2. Enable and view image versions as follows:
 - a. Press the **Options** key. The following menu appears on the generator's display:

-More	
	Red+
-NoGamma	Green+
-Noise	Blue+

- b. Choose the **More** item by pressing the adjacent soft key until a + and Rendition appears next to the item.

+More	Rendition: 000
	Red+
-NoGamma	Green+
-Noise	Blue+

- c. Press the + and - keys to advance through the image versions.

Alternatively, to enable and view image versions using the command line interface, enter the following commands:

```
ISUB 1 // Enables sub images
IVER 1 // Specifies the first image version
IMGU // Activates the image version
```

3. When you are finished, disable image versions by pressing the **Options** key and choosing **More** until a - appears next to it.

Alternatively, to disable image versions using the command line interface, enter the following command:

```
ISUB 0 // Disables sub images
```

Creating custom images

This section describes how to create images using drawing primitive commands and add them to the generator's Content list. The recommended method for sending drawing primitive commands to the generator is to create a text file containing the commands for creating the image, and then transferring the text file to the generator. For more information about using command files, see [“Sending command files \(serial interface only\)”](#) on page 34.

To create a custom image with a text file:

1. Using a text editor, open a text file on your computer and enter the following commands.

```
OUTG 0 // gates all video and sync outputs off
IMGN new_image // creates a new image
IMGB // begins an image editing session
XRES 640 // sets the horizontal resolution to 640
YRES 480 // sets the vertical resolution to 480
.
. // image drawing primitives
.
IMGE // ends an image editing session
IMGA path/new_image // saves image as new_image in specified path
OUTG 1 // gates all video and sync outputs on
IMGU // draws the image
ALLU // applies buffer to the generator hardware
```

2. Save the text file with a *.txt extension.
3. Set the image path to the image folder where you want to store your image.

```
IMGP /tffs0/Library/Images // sets image path to folder in flashmem
```
4. Establish a terminal session with the generator. See [“Establishing a terminal session with the 882”](#) on page 30.
5. At the R:> prompt, transfer the text file to the generator. For example, to transfer a file using HyperTerminal, do the following:
 - a. On the **Transfer** menu, click **Send Text File**. The **Send Text File** dialog box appears.
 - b. Select the text file you want to send, and then click **Open**. HyperTerminal displays the commands as they are sent.
 - c. Press **Enter** once to ensure that the last command is sent.

The generator processes the commands and creates an image XML file in the Images folder you specified above.

Command file example

The following sample command file creates the image shown in the graphic below.

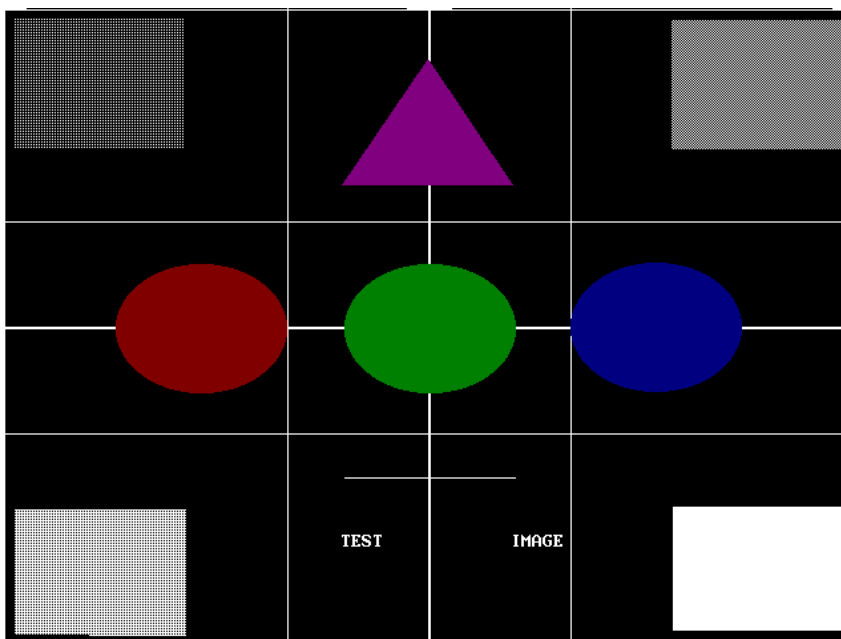

Commands used to draw image above:

```
IMGN
IMGB // begins an editing session
XRES 640 // sets the horizontal resolution
YRES 480 // sets the vertical resolution
RECT White 129 97 7 8 GrayPat25
GRID White 3 3
LIMI White
CROS White
TRIA Magenta50 319 38 254 133 383 133 GrayPat100
OVAL Green50 129 97 256 192 GrayPat100
RECT White 129 97 8 376 GrayPat75
RECT White 129 97 502 9 GrayPat50
RECT White 129 97 503 374 GrayPat100
OVAL Blue50 129 97 426 191 GrayPat100
OVAL Red50 129 97 84 192 GrayPat100
LINE White 256 352 384 352
TEXT White 253 393 sys16 "TEST IMAGE"
IMGE // ends an editing session
IMGA /tffs0/Library/Images/MyImage.xml // saves image as MyImage
```

Note: It is recommended that you save custom images in a directory on the PCcard because of file storage limitations in the Flashmem.

Editing images

When you create an image using the command line interface, the generator produces an image XML file. This XML file can be edited with any standard text editor. The XML file created from the above command file is shown below.

```
<?xml version="1.0" encoding="UTF-8" ?>
<DATAOBJ>
  <HEADER TYPE="IMG" VERSION="1.0" ></HEADER>
  <DATA>
    <PRIM>RECT White 129 97 7 8 graypat25</PRIM>
    <PRIM>GRID White 3 3</PRIM>
    <PRIM>LIMI White</PRIM>
    <PRIM>CROS White</PRIM>
    <PRIM>TRIA Magenta50 319 38 254 133 383 133 graypat100</PRIM>
    <PRIM>OVAL Green50 129 97 256 192 graypat100</PRIM>
    <PRIM>RECT White 129 97 8 376 graypat75</PRIM>
    <PRIM>RECT White 129 97 502 9 graypat50</PRIM>
    <PRIM>RECT White 129 97 503 374 graypat100</PRIM>
    <PRIM>OVAL Blue50 129 97 426 191 graypat100</PRIM>
    <PRIM>OVAL Red50 129 97 84 192 graypat100</PRIM>
    <PRIM>LINE White 256 352 384 352</PRIM>
    <PRIM>TEXT White 253 393 Sys16 "TEST IMAGE"</PRIM>
  </DATA>
</DATAOBJ>
```

Rendering bitmap images

Bitmap images residing in the generator's flash memory, on the PC card, or on the file server can be rendered on a display by selecting the image through the front panel or the command line interface. This section describes how to store and render bitmap images.

To render a bitmap image using the front panel:

1. Copy the bitmap image to the Image folder on either the file server or the generator's flash memory or PC card. See ["Copying files from a PC to a 882"](#) on page 23.

Note: *You can transfer either a single bitmap or an entire folder of bitmaps. It is recommended that you save bitmaps in a directory on the PCcard because of file storage limitations in the Flashmem.*

2. Set the generator's image path to the image folder on the desired medium. See ["Setting the 882's path"](#) on page 17.
3. If necessary, place the generator in Basic mode by pressing and holding the **Tools** key.
4. Press the **Content** key. A list of images appears on the generator's display.
5. Press the soft key adjacent to the desired image to render the bitmap on the display.

To render a bitmap image using the command line interface:

1. Copy the bitmap image to the Image folder on either the file server or the generator's flash memory or PC card. See ["Copying files from a PC to a 882"](#) on page 23.

Note: *You can transfer either a single bitmap or an entire folder of bitmaps.*

2. Establish a terminal session with the generator. See ["Establishing a terminal session with the 882"](#) on page 30.
3. Set the generator's image path to the image folder on the desired medium. In the command syntax, specify the medium as follows:
 - Flash memory: tffs0
 - PC card: card0
 - File server: server_name (case sensitive without a forward slash in front, and with a colon after the name)

Enter the following command for flash memory and PC card:

```
IMGP /medium/Library/Images
```

Enter the following command for file server:

```
IMGP server_name:
```

4. Enter the following commands to select and render the image from flash memory or PC card:

```
IMGL image_name // Select the test image  
IMGU           // Draw the selected test image
```

Setting image component values

You can increment the color component values or can decrement the color component values for all pixels of any image through the front panel or the command line. This feature enables you to increment or decrement the values in increments (or decrements) of 1, 10 or 100 throughout a range of 0 to 255 through the front panel or by any increment 1 or greater through the command line. The LEVP feature increments or decrements all color component values (R,G,B) for each action by the user either through the command line or through the front panel.

You can also increment the R, G, B color component values individually through the command line in increments of 1 or greater using the `LEVP:R` command. And you can use the `LEVP:R` and `LEVP` commands together.

Note: *These commands are best used with component color formats (RGB color scheme). The color mode is set by the AVST or DVST command. AVST 2 is analog RGB color mode; DVST 10 is digital RGB color mode. If you have a format and configuration with color difference (YPbPr or YCbCr) you see a reduction or increase of the chrominance difference values but the Y component values will remain. Therefore as your reduce the color component values for red, green and blue you will see a pronounced green image.*

This subsection describes these procedures.

To increment or decrement all color component values for an image:

1. Select an image by pressing the **Content** key.
2. Press the **Options** key repeatedly to access the component increment menu. The following menu appears on the generator's display:

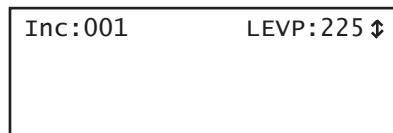

3. Set the increment value to either 001, 010 or 100 by pressing the soft key adjacent to the **Inc:001** item on the menu.
4. Increment or decrement the image color component values by pressing the + and - keys.

To increment or decrement all color component values for an image through the command line:

1. Select any image you want to modify by pressing the **Content** key.

Alternatively you can enter the following command:

```
IMGL SMPTEBar // Loads the SMPTEbar test image
IMGU // Renders the test image that is loaded
```

2. Enter the following commands to set the color component values:

```
LEVP:R 52          // Sets all color component (R,G,B) at 52% full
color
```

To increment or decrement each color component value individually for an image:

1. Select any image you want to modify by pressing the **Content** key.

Alternatively you can enter the following command:

```
IMGL SMPTEBar    // Loads the SMPTEbar test image
IMGU             // Renders the test image that is loaded
```

2. Enter the following commands to select and render the image:

```
LEVP:R 33        // Sets the red component at 33% of maximum color
LEVP:G 50        // Sets the green component at 50% of maximum color
LEVP:B 66        // Sets the blue component at 66% of maximum color
```

Creating image catalogs

An image catalog is an XML file that lists image names. When a catalog is enabled, the image names in the catalog appear in the Content list. You can create image catalogs and use them to control which image names appear when you press the Content key. If your test environment requires only a subset of the built-in images (for example, only images for testing TV CRTs), you can create an image catalog containing only those image names. You can arrange the image names in the order you want them to appear in the Content list, and you can create multiple catalogs and use them simultaneously. You can create an image catalog with images from the default library or custom images created either with the SDK or through the command line.

Creating image catalogs is a two-step process. The first step is to create the catalog. The second step is to add the catalog to the Content library. Once in the Content library, you can enable one or more catalogs to control which images appear when you press the Content key.

Creating an image catalog

The process for creating image catalogs is somewhat different than creating format catalogs. The generator is not configured with an image catalog library as there is for formats. Therefore you first have to create an image library (ImageLib) to put the image catalogs in. Also the images are stored in cache and because of this there is some administration overhead involved in re-establishing the default content list of images that is not required for the source list of formats.

Image catalogs are created using the command line interface. Although the catalog itself is a file, you will use the Directory (DIR) commands to create the file. Follow the procedures below to create an image catalog and add it to the Content library.

To create an image catalog using the Generator FTP Browser:

1. Access the generator's Virtual Front Panel. See "[Working with the Virtual Front Panel](#)" on page 20.

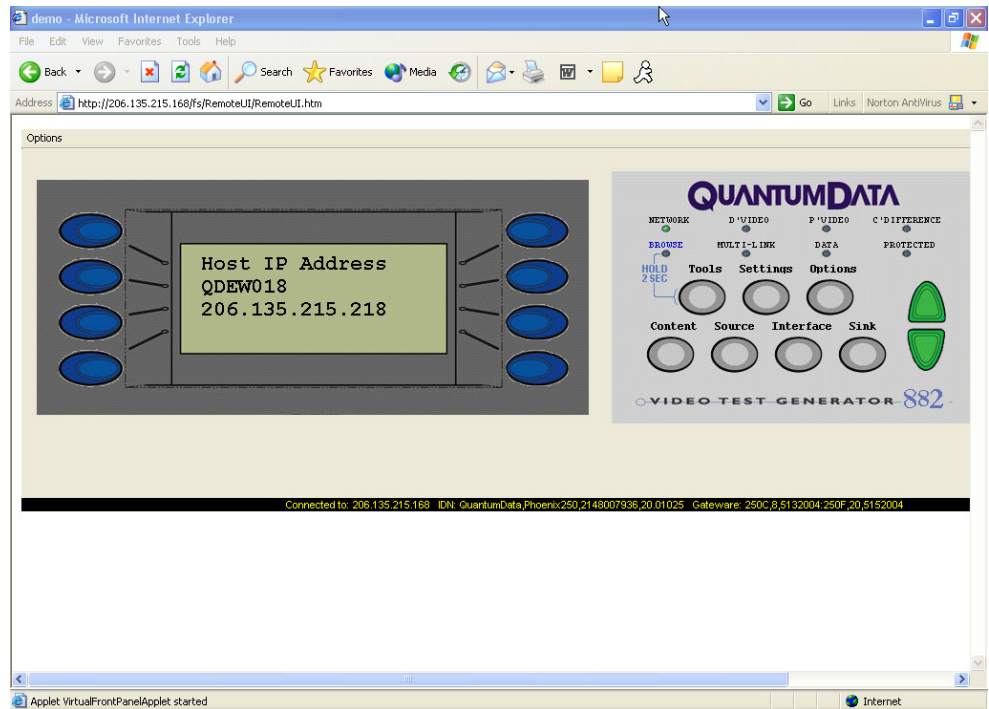

2. From the **Options** menu (upper left corner of the Virtual Front Panel), choose the **FTP Browser** menu item. The Generator FTP Browser appears.
3. In the **Instrument Files** area, click the down arrow by the **Look in** box and select **tffs0**. This is the generator's flash memory.

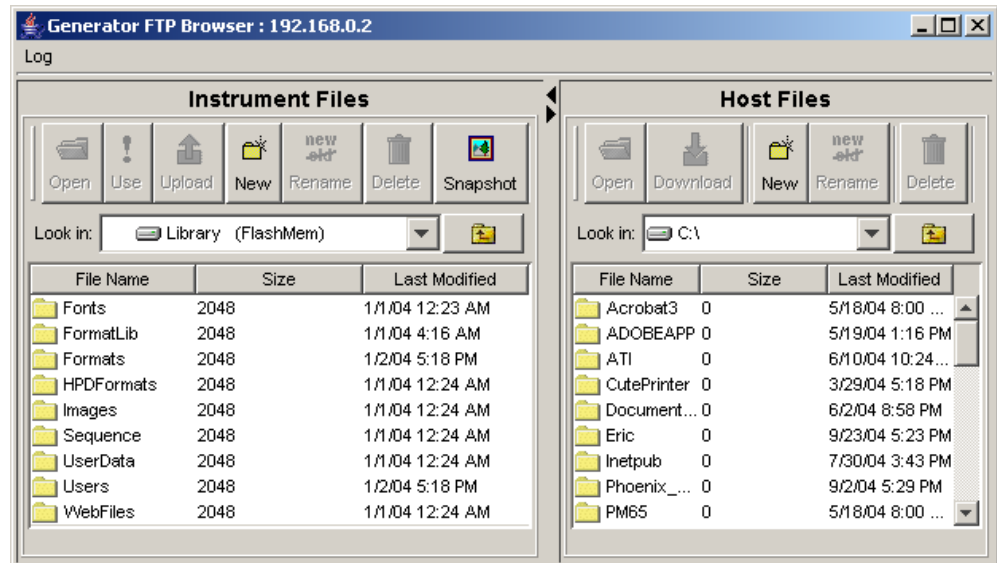

4. Create a folder named ImageLib as follows:
 - a. Click the **New** button. The Enter a New Folder Name dialog box appears.

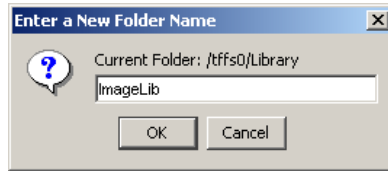

- b. Enter **ImageLib** in the box, and then click **OK**. The ImageLib folder appears in the list of files and folders.

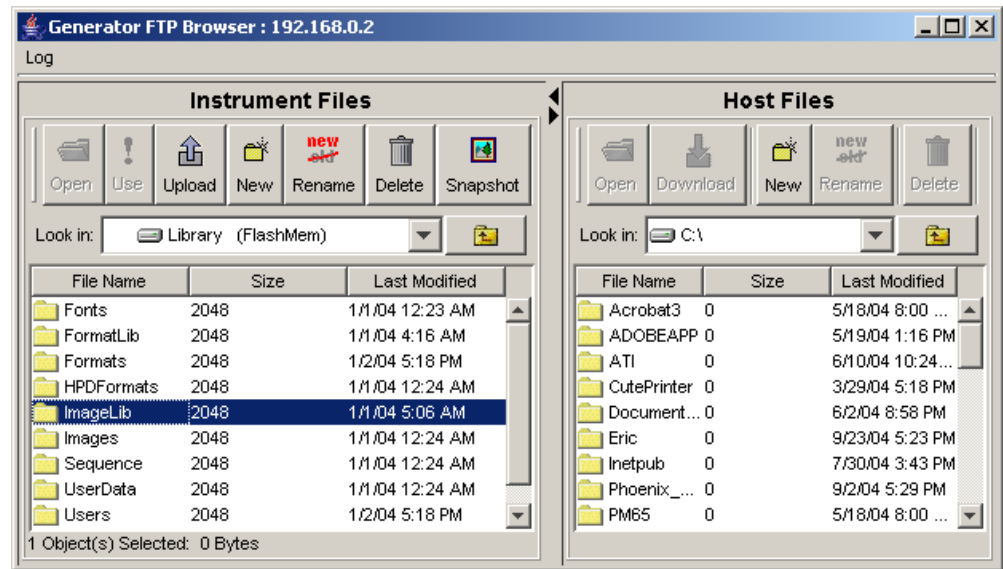

To create an image catalog using the command line interface:

1. Determine the images you want to include in your catalog. For example, you may want to create a catalog that includes the following images for testing CRT televisions:

```
SMPTE133    SMPTEBar
TVBar100    PulseBar
Regulate    Geom_1
```

Or, you may want to create a catalog that includes custom images created using the SDK or the command line.

```
Ramp        Flat
barpulse    myimage
SMPTE133    Grays32
```

2. Establish a session with the generator using either HyperTerminal over a serial connection or Telnet over an Ethernet LAN see [“Establishing a terminal session with the 882”](#) on page 30 or [“Establishing a Telnet session with the 882”](#) on page 33.
3. Create the catalog by entering the commands shown below. This example creates a catalog called TVimages.xml.

```

DIRN TVImages      // creates a catalog named TVImages
DIRT Content      // identifies the catalog as a Content catalog
DIRB              // begins a directory editing session
NAMI 1 /Cache0/Images/SMPTE133      // add SMPTE133 to catalog
.
.
.
.
.
.
NAMI 6 /Cache0/Images/Geom_1        // add Geom_1 to catalog
DIRE              // ends the directory editing session
DIRA /tffs0/Library/ImageLib/TVImages // saves the catalog
DIRL /tffs0/Library/ImageLib/TVImages // loads the TVImages catalog
DIRU              // applies the TVImages catalog

```

This example creates a catalog called FPDImage.xml.

```

DIRN FPDImage      // creates a catalog named FPDImage
DIRT Content      // identifies new catalog as a content catalog
DIRB              // begins a directory editing session
NAMI 1 /Cache0/Images/Ramp          // add Ramp to the catalog
NAMI 2 /Cache0/Images/Flat
NAMI 3 /tffs0/Library/userdata/myimage // adds a custom image created
                                         through the command line
NAMI 4 /tffs0/Library/Images/barpulse.o // adds a custom image created
                                         through the SDK

NAMI 4 /Cache0/Images/SMPTE133
NAMI 6 /Cache0/Images/Grays32      // add Grays32 to catalog
DIRE              // ends the directory editing session
DIRA /tffs0/Library/ImageLib/FPDImages // saves the catalog
DIRL /tffs0/Library/ImageLib/FPDImages // loads the FPDImages catalog
DIRU              // applies FPDImages catalog

```

To restore the default image library:

1. Power cycle the generator.

Or, you can restore the default Source list of images by entering the commands below.

```

DIRN              // creates a blank catalog
DIRB              // begins a directory editing session
DIRT Contentlib  // identifies new catalog as a contentlib catalog
DIRE              // ends the directory editing session
DIRU              // applies the empty catalog

```

To restore the custom image library:

1. You can restore your custom Source list of images by entering the commands below.

```

DIRL /tffs0/Library/ImageLib/FPDImages // loads the FPDImages catalog
DIRU              // applies FPDImages catalog

```

To enable catalogs in the Content list using the front panel:

1. Press the **Content** key. The list of images appears on the generator's display.

2. Press the **Options** key repeatedly until the Library folder appears on the generator's display as shown below:



3. Choose the **Library** item by pressing the adjacent soft key. The image library appears as shown below. Each item in the image library is an image catalog.



4. Press the soft key adjacent to a catalog to enable or disable it. A + sign next to the item indicates the item is enabled; a - sign indicates it is disabled.
5. Press the **Content** key to see the images in the selected catalogs.

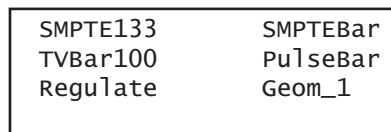

To remove an image from a catalog:

1. Establish a session with the generator using either HyperTerminal over a serial connection or Telnet over an Ethernet LAN. see [“Establishing a terminal session with the 882”](#) on page 30 or [“Establishing a Telnet session with the 882”](#) on page 33.
2. To remove an image from a catalog, enter the following commands:

```
DIRL /tffs0/Library/ImageLib/TVImages // loads the TVImages catalog
DIRT ContentLib // identifies directory as a content directory
DIRB // begins a directory editing session
NAMK /cache0/Library/Images/TVImages/SMPTE133.img
Or...
NAMY 1 // deletes SMPTE133 (index 1)
DIRE // ends the directory editing session
DIRS // saves the catalog
```

Deleting an image catalog

You can delete an image catalogs either through the command line or through the Generator FTP Browser. Procedures for both methods are provided below.

To delete a image catalog using the Generator FTP Browser:

1. Access the source generator's Virtual Front Panel. See "[Working with the Virtual Front Panel](#)" on page 20.

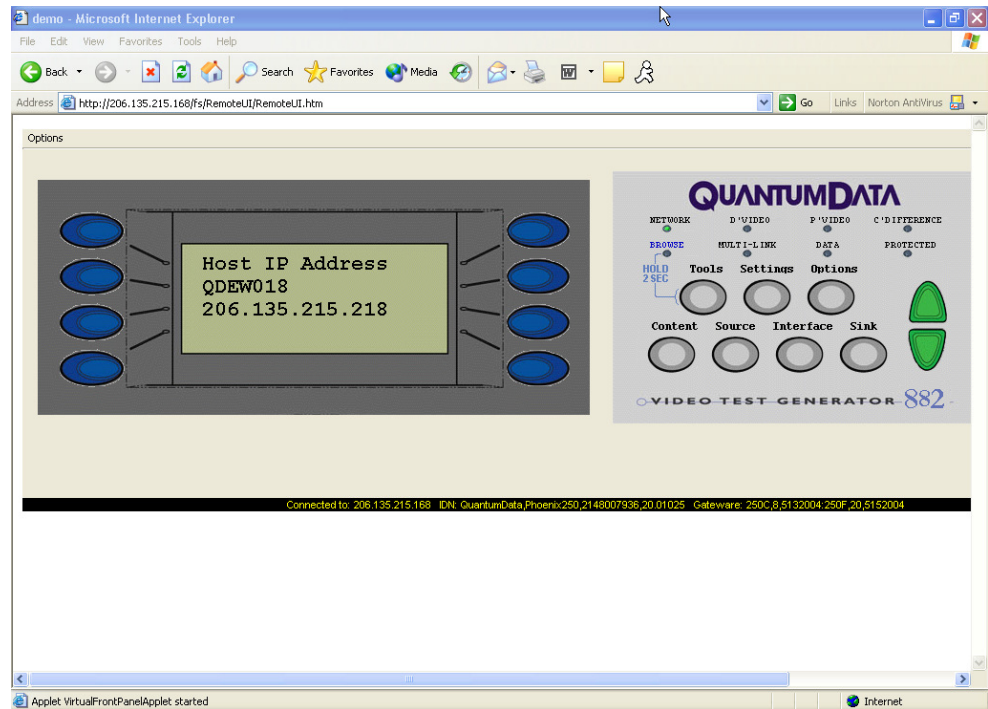

2. From the **Options** menu (upper left corner of the Virtual Front Panel), choose the **FTP Browser** menu item. The Generator FTP Browser appears.
3. In the **Instrument Files** area, click the down arrow by the **Look in** box and select **tffs0**. This is the generator's flash memory.
4. Double click the **Library** folder, and then double click the **ImageLib** folder to open it.

5. Select the catalog file you want to delete, and then click the **Delete** button. A message appears asking you to confirm that you want to delete the file. Click **OK**.

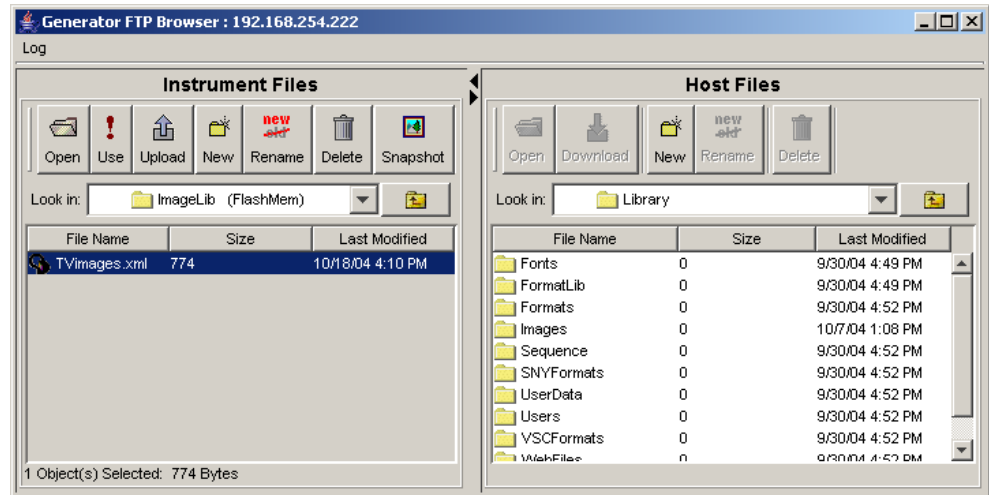

8 Working with Test Sequences

Topics in this chapter:

- [Overview](#)
- [Viewing the test sequence list](#)
- [Running a test sequence](#)
- [Creating a test sequence](#)
- [Deleting a test sequence](#)

Overview

When testing video displays, you typically select a format using the Source key, and then select an image using the **Content** key. In a production environment, where there might be a need to test several combinations of formats and images, you can create a test sequence to automate the process of selecting formats and images. Test sequences provide a way to progress through a pre-defined sequence of format and images, either manually or automatically. Multiple test sequences can be stored in the generator and selected by the operator.

This section describes how to create and run test sequences. New test sequences are created through the command line interface and stored as XML files. Existing sequences can be modified by editing the sequence XML files using a text editor. Test sequences can be activated (run) or deactivated through the generator front panel or the command line interface.

Viewing the test sequence list

You can view the list of test sequences stored in the generator using the generator front panel controls or the command line interface.

Viewing the test sequence list using the front panel

Use the following procedure to view the test sequence list using the generator's front panel.

To view the sequence list using the front panel:

1. Press the **Tools** key. The Tools menu appears as shown below:

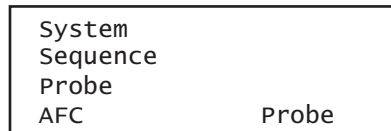

2. Choose the **Sequence** item by pressing the adjacent soft key.

A list of sequences appears as shown below. If necessary, press the - key to scroll down the list.

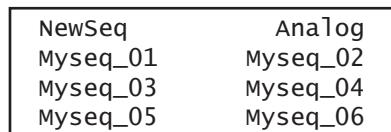

Viewing the test sequence list using the command line interface

Use the following procedure to view the test sequence list using the command line interface.

To view the sequence list using the command line interface:

1. Establish a session with the generator using either HyperTerminal over a serial connection or Telnet over an Ethernet LAN. See [“Establishing a terminal session with the 882”](#) on page 30 or [“Establishing a Telnet session with the 882”](#) on page 33.
2. Set the sequence path to the medium and location you want to query. For example, if you want to view the sequence files in the generator's flash memory, enter the following command:

```
SEQP /tffs0/Library/Sequence
```

To set the sequence path to view the sequence files on the PC card, enter the following command:

```
SEQP /card0/Library/Sequence
```

3. List the contents of the sequence folder by entering the following command:

```
SEQQ? 1 4 // lists test sequences from the first through the fourth
```

Running a test sequence

Test sequences are initiated through the generator's front panel or the command line interface. A sequence can run in one of three modes:

- Step and stop mode, where the progression of the sequence is under user control, and the sequence halts after the final step.
- Step and wrap mode, where the progression of the sequence is under user control, and it continuously loops (repeats the sequence steps).
- Automatic mode, which enables automatic progression through the sequence list with continuous looping.

The instructions for running test sequences using the front panel and command line interface are provided below.

Running a test sequence using the front panel

To run a sequence using the front panel:

1. Press the **Tools** key. The Tools menu appears as shown below:

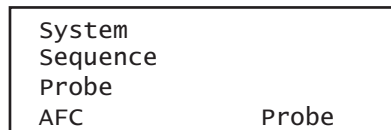

2. Choose the **Sequence** item by pressing the adjacent soft key. To see all of the sequences, press the + and - keys.

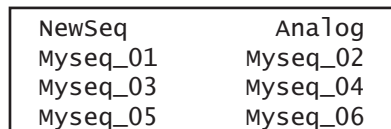

- Choose the sequence you want to run by pressing the adjacent soft key. The settings for the selected sequence are shown on the generator's display:

+Red myseq	ACS
+Grn Auto:00001	DCS
+Blu DMT0660	DSS*
Inv SMPTE133	Out+

Depending on the mode of the sequence, the sequence will either start automatically, or you can press the + or - keys to move forward or backward manually through the sequence steps.

The generator's display shows the format and image name for each step, the mode, and the current step number. Additionally, the sync gate status and output status appear on the right, and the color gate status appears on the left, as shown below.

+Red myseq	ACS
+Grn Step:00001	DCS
+Blu DMT0660	DSS*
Inv SMPTE133	Out+

To stop a sequence or change the sequence mode:

- With a sequence running, press the **Options** key. The mode menu appears as shown below.

*Step
Wrap
Auto
Stop

- Choose the desired mode by pressing the adjacent soft key.

Mode	Description
Step	Step and stop mode
Wrap	Step and wrap mode
Auto	Automatic mode.
Stop	Stops the sequence

- Press the **Options** key to return to the sequence settings.

Running a test sequence using the command line interface

To run a sequence using the command line interface:

- Establish a session with the generator using either HyperTerminal over a serial connection or Telnet over an Ethernet LAN. See "[Establishing a terminal session with the 882](#)" on page 30 or "[Establishing a Telnet session with the 882](#)" on page 33.

2. Enter the following commands:

```
SEQL seqname // loads the sequence into sequence edit buffer
SMOD 1 // where 1=step&stop; 2=step&wrap; 3=auto
SEQU // starts running the sequence
```

The generator's display shows the format and image name for each step, the mode, and the current step number. Additionally, the sync gate status and output status appear on the right, and the color gate status appears on the left, as shown below:

+Red myseq	ACS
+Grn Step:00001	DCS
+Blu DMT0660	DSS*
Inv SMPTE133	Out+

If the sequence is set to auto, it begins running. Otherwise, press the + and - keys to move through the sequence steps.

To stop a sequence:

Enter the following command:

```
SMOD 0
SEQU
```

To run a sequence at power up:

1. Run the sequence in the desired mode.
2. Cycle the power to the generator. Depending on the selected mode, the sequence will start automatically, or you can press the + and - keys to step through the sequence.

Creating a test sequence

You create test sequences using the command line interface. Test sequences consist of multiple steps. Each step specifies the format and image to display, as well as the duration of the step. You can create multiple sequence files, which are stored in the generator's flash memory.

Creating a test sequence using the command line interface

You can develop test sequences using the command line interface, either by entering commands interactively through a terminal session or by entering a series of commands in a text file and then sending the file to the generator through a terminal emulation program such as HyperTerminal. When developing long test sequences, the recommended procedure is to enter commands in a text file, and then send the file to the generator. This approach enables you to change the test sequence without entering the entire command script.

It is important to note that for digital formats you will need to create separate formats using the format editor to ensure that the digital video signal type (DVST) is set properly. When a format is loaded during a test sequence its video type defaults to analog. So if you want to create for example a test sequence for HDMI for testing high definition televisions you will need to create the HDMI version of the format setting DVST appropriately. Examples are provided below.

Use the following procedure to create a test sequence and save it to the sequence directory on the generator.

To create and save an analog test sequence interactively using the command line interface:

1. Establish a session with the generator using either HyperTerminal over a serial connection or Telnet over an Ethernet LAN. See [“Establishing a terminal session with the 882”](#) on page 30 or [“Establishing a Telnet session with the 882”](#) on page 33.
2. Set the sequence path to the sequence directory in the generator's flash memory or on the PC card. For example, to set the path to the generator's flash memory, enter the following command:

```
SEQP /tffs0/Library/Sequence
```

To set the sequence path to the PC card, enter the following command:

```
SEQP /card0/Library/Sequence
```

3. Enter the following commands to create a three-step sequence named *MySeq*.

```
SEQN          // initializes the sequence edit buffer
SEQB          // begins a sequence editing session
STEP 1        // selects a step to be edited
SDLY 5.0      // sets the delay for the current step to five seconds
```



```

FMTL 480p59 // loads a format
IMGL SMPTEbar // loads an image
STEP 2 // selects a step to be edited
SDLY 5.0 // sets the delay for the current step to five seconds
FMTL 720p60 // loads a second format (same image)
IMGL Outline1 // loads an image
STEP 3 // selects a step to be edited
SDLY 5.0 // sets the delay for the current step to five seconds
FMTL 1080i29 // loads a third format
IMGL Geom_4 // loads another image
SEQE // ends the sequence editing session
SEQA MySeq // saves the current contents of the sequence editor

```

After sending the last command, the file is automatically converted to an XML file and is available to use at the generator.

To create and save an analog test sequence from a text file:

1. Using a text editor, open a text editor on your computer and enter the following commands to create a three-step sequence named *MySeq*:

```

SEQN // initializes the sequence edit buffer
SEQB // begins a sequence editing session
STEP 1 // selects a step to be edited
SDLY 5.0 // sets the delay for the current step to five seconds
FMTL 480p59 // loads a format
IMGL SMPTEbar // loads an image
STEP 2 // selects a step to be edited
SDLY 5.0 // sets the delay for the current step to five seconds
FMTL 720p60 // loads a second format (same image)
IMGL Outline1 // loads an image
STEP 3 // selects a step to be edited
SDLY 5.0 // sets the delay for the current step to five seconds
FMTL 1080i29 // loads a third format
IMGL Geom_4 // loads another image
SEQE // ends the sequence editing session
SEQA MySeq // saves the current contents of the sequence editor

```

Note: If you wish to use a format or image that is in a location that is not the current location of the format path (*fntp*) or image path (*imgp*) you will have to specify the complete path. For example if you want to use an image from the PCcard in the Library/Image directory you would use the following:

```
IMGL /card0/library/images/SMPTEbar // loads an image from PCcard
```

And if you wanted to use a format from the PCcard but the current format path was set to Flashmem, you would enter the following:

```
FMTL /card0/library/formats/DMT0660a // loads a format from PCcard
```

2. Save the text file with a .txt extension.

Note: When you send the .txt file to the generator, the file will be automatically converted to an XML file.

3. Set the sequence path to the sequence directory on the generator's flash memory or the PC card. For example, to set the path to the generator's flash memory, enter the following command:

```
SEQP /tffs0/Library/Sequence
```

To set the sequence path to the PC card, enter the following command:

```
SEQP /card0/Library/Sequence
```

4. Establish a session with the generator using either HyperTerminal over a serial connection or Telnet over an Ethernet LAN. See "[Establishing a terminal session with the 882](#)" on page 30 or "[Establishing a Telnet session with the 882](#)" on page 33.
5. Transfer the text file to the generator. For example, to transfer the file using HyperTerminal, do the following:
 - a. On the **Transfer** menu, click **Send Text File**. The **Send Text File** dialog box appears.
 - b. Select the text file you want to send, and then click **Open**. HyperTerminal displays the commands as they are sent.
 - c. Press **Enter** once to ensure that the last command is sent.

To create and save a test sequence with HDMI digital formats using a text file:

1. Create HDMI digital versions of the formats you will be using in the test sequence.

We recommend using the Format Editor. Please refer to “[Creating custom formats using the Format Editor](#)” on page 186.

- a. Load the format that you wish to use.
- b. Specify the Color Encoding Method to set the digital video signal type as in the example below:

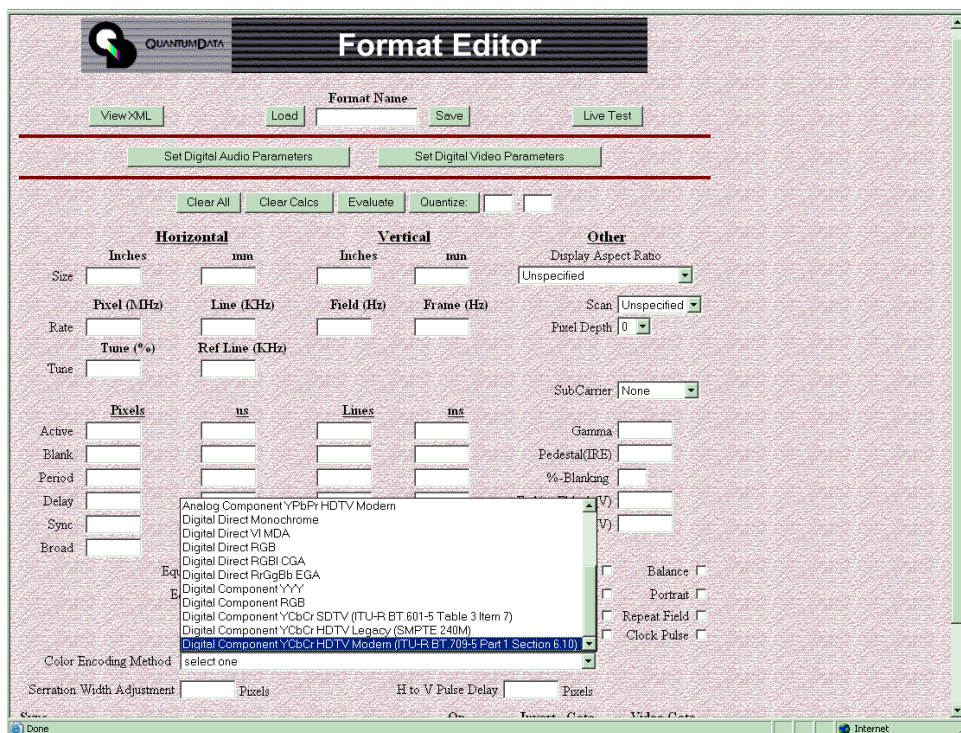

- c. Save the format under a different name. For example if you are using 1080p60, you might name the new format as 1080p60h.
2. Using a text editor, open a text editor on your computer and enter the following commands to create a three-step sequence named *MySeq*:

```
SEQN           // initializes the sequence edit buffer
SEQB           // begins a sequence editing session
STEP 1         // selects a step to be edited
SDLY 5.0       // sets the delay for the current step to five seconds
FMTL 1080p60h // loads an HDMI digital format
IMGL SMPTEbar // loads an image
STEP 2         // selects a step to be edited
SDLY 5.0       // sets the delay for the current step to five seconds
FMTL 720p60h  // loads a second format (same image)
IMGL Outline1 // loads an image
STEP 3         // selects a step to be edited
SDLY 5.0       // sets the delay for the current step to five seconds
FMTL 1080i29h // loads a third format
```

```
IMGL Geom_4    // loads another image
SEQE          // ends the sequence editing session
SEQA MySeq    // saves the current contents of the sequence editor
```

3. Save the text file with a .txt extension.

Note: When you send the .txt file to the generator, the file will be automatically converted to an XML file.

4. Set the sequence path to the sequence directory on the generator's flash memory or the PC card. For example, to set the path to the generator's flash memory, enter the following command:

```
SEQP /tffs0/Library/Sequence
```

To set the sequence path to the PC card, enter the following command:

```
SEQP /card0/Library/Sequence
```

5. Establish a session with the generator using either HyperTerminal over a serial connection or Telnet over an Ethernet LAN. See “[Establishing a terminal session with the 882](#)” on page 30 or “[Establishing a Telnet session with the 882](#)” on page 33.
6. Transfer the text file to the generator. For example, to transfer the file using HyperTerminal, do the following:
 - a. On the **Transfer** menu, click **Send Text File**. The **Send Text File** dialog box appears.
 - b. Select the text file you want to send, and then click **Open**. HyperTerminal displays the commands as they are sent.
 - c. Press **Enter** once to ensure that the last command is sent.

Editing a test sequence XML file

You can modify an existing test sequence by copying the sequence XML file from the generator to a PC, editing the file, and then transferring the file back to the generator. Use the following procedure to edit an existing test sequence XML file.

To edit a test sequence:

1. Using the Generator FTP Browser, copy the sequence XML file from the generator to a PC. See “[Copying files from a 882 to a PC](#)” on page 25 for instructions.

Note: You can also copy the contents of a test sequence file from the Generator FTP Browser to your text editor. Locate the file you want to copy in the *Instrument Files* area of the Generator FTP Browser window. Select the file, and then click the *Open* button. The sequence XML file will open in a window. Press **CTRL-A** to select the contents of the window. Press **CTRL-C** to copy the selected text. You can then paste the contents into a text editor on your PC.

2. Open the XML file in a standard text editor.

A sample sequence XML file for the sequence named MySeq01 is shown below:

```
<?xml version="1.0" encoding="UTF-8" ?>
<DATAOBJ>
  <HEADER TYPE="SEQ" VERSION="1.0" ></HEADER>
  <DATA>
    <STEP>
      <FMT>/tffs0/Library/TestAnalog/DMT0660.xml</FMT>
      <IMG>master.img</IMG>
      <DELAY>+3.0000000E+00</DELAY>
    </STEP>
    <STEP>
      <FMT>/tffs0/Library/TestAnalog/DMT0659.xml</FMT>
      <IMG>SMPTEBar.img</IMG>
      <DELAY>+3.0000000E+00</DELAY>
    </STEP>
    <STEP>
      <FMT>/tffs0/Library/TestAnalog/DMT0675.xml</FMT>
      <IMG>SMPTE133.img</IMG>
      <DELAY>+3.0000000E+00</DELAY>
    </STEP>
    <STEP>
      <FMT>/tffs0/Library/TestAnalog/DMT0685.xml</FMT>
      <IMG>Flat.img</IMG>
      <DELAY>+3.0000000E+00</DELAY>
    </STEP>
    <STEP>
      <FMT>/tffs0/Library/TestAnalog/DMT0856.xml</FMT>
      <IMG>Grill_11.img</IMG>
      <DELAY>+3.0000000E+00</DELAY>
    </STEP>
    <STEP>
      <FMT>/tffs0/Library/TestAnalog/DMT0680.xml</FMT>
      <IMG>Hatch4x3.img</IMG>
      <DELAY>+3.0000000E+00</DELAY>
    </STEP>
    <STEP>
      <FMT>/tffs0/Library/TestAnalog/DMT0872.xml</FMT>
      <IMG>ColorBar.img</IMG>
      <DELAY>+3.0000000E+00</DELAY>
    </STEP>
    <STEP>
      <FMT>/tffs0/Library/TestAnalog/DMT0885.xml</FMT>
      <IMG>Ramp.img</IMG>
      <DELAY>+3.0000000E+00</DELAY>
    </STEP>
  </DATA>
</DATAOBJ>
```

3. Make the edits in the XML file as necessary. An example is provided below showing how to change the format, image, and delay for the second step in the test sequence.

Before:

```
...  
<STEP>  
  <FMT>/tffs0/Library/TestAnalog/DMT0659.xml</FMT>  
  <IMG>SMPTEBar.img</IMG>  
  <DELY>+3.0000000E+00</DELY>  
</STEP>  
...
```

After (modified text in bold):

```
...  
<STEP>  
  <FMT>/tffs0/Library/TestAnalog/DMT0856.xml</FMT>  
  <IMG>PulseBar.img</IMG>  
  <DELY>+4.0000000E+00</DELY>  
</STEP>  
...
```

4. Save the text file as an XML file.
5. Using the Generator FTP Browser, download the format XML file from your PC to the generator. See [“Copying files from a PC to a 882”](#) on page 23 for instructions.

Deleting a test sequence

You can delete a test sequence using the command line interface.

To delete a test sequence using the command line interface:

1. Establish a session with the generator using either HyperTerminal over a serial connection or Telnet over an Ethernet LAN. See [“Establishing a terminal session with the 882”](#) on page 30 or [“Establishing a Telnet session with the 882”](#) on page 33.
2. Set the sequence path to the medium and location you want to query. For example, if you want to delete the sequence files in the generator’s flash memory, enter the following command:

```
SEQP /tffs0/Library/Sequence
```

To delete sequence files on the PC card, enter the following command:

```
SEQP /card0/Library/Sequence
```

3. Delete the sequence by entering the following commands:

```
SEQK seqname
```

```
ALLU
```

9 Testing HDMI Sink Devices

Topics in the chapter:

- [Overview of HDMI display testing](#)
- [Setting up the 882 for HDMI testing](#)
- [Testing HDMI displays](#)
- [Testing HDMI 1.4 displays with 3D](#)
- [Testing HDMI video pixel repetition \(882 only\)](#)
- [Testing HDMI audio](#)
- [Testing HDMI InfoFrames \(882 only\)](#)

Overview of HDMI display testing

This section describes how to test digital displays with HDMI interfaces. The HDMI option enables the 882 to test HDMI-compliant displays. With the HDMI option, the 882 outputs HDMI-compatible TMDS video and data packets containing audio and auxiliary information.

Note: This chapter does not provide HDMI compliance test procedures. HDMI EDID compliance testing procedures are provided in [“Testing EDID for HDMI compliance in display \(sink\) devices”](#) on page 330.

The HDMI option provides the following features:

- Advanced E-EDID parsing
- Generation of all EIA/CEA-861-D formats below 165 MHz
- Pixel repetition test capabilities
- Internal sine wave 882 up to 8 channels and external SPDIF audio input for audio testing
- AFD test capabilities
- Automatic and manual InfoFrame configuration

Physical connections

The 882 has two HDMI OUT(Tx) connectors for testing HDMI displays. In addition, the 882 also has an SPDIF-A/V connector which allows external SPDIF audio to be input to the HDMI signal. To use the SPDIF-A/V connector, an RCA-to-VGA cable is included with the 882.

The video interfaces on the 882D are shown below.

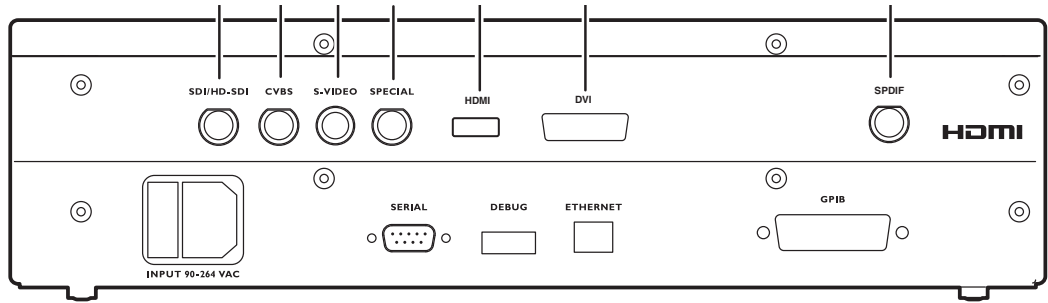

Interface	Description
1	SDI/HD-SDI connector outputs a serial digital signal per SMPTE 259M and SMPTE 292M standards.
2	CVBS connector outputs an analog composite video baseband signal in accordance with SMPTE 170M standard.
3	S-VIDEO connector outputs an S-Video split luminance (Y) and chrominance (C) analog video signal.
4	SPECIAL connector provides multiple outputs, including: <ul style="list-style-type: none"> digital composite sync line sync frame sync movable scope trigger (probe) pulse pixel clock signal
5	HDMI OUT connector outputs full single link HDMI video, as well as DVI and modern HDMI-compatible digital video signals.
6	DVI connector outputs full dual link HDMI video.
7	SPDIF connector inputs audio from an external source.

Format selection

To support HDMI, the 882 provides pre-defined formats for every video format specified in the EIA/CEA-861-E standard. These pre-defined formats support all aspects of the HDMI signal (video, audio, and auxiliary data).

The following table lists those 882 formats used to test support for HDMI (EIA/CEA-861-E).

EIA/CEA-861-E Video Identification Code	Quantum Data format
1	DMT0659, DMT0660
2	480p59, 480p60, 480p59LH, 480p60LH

EIA/CEA-861-E Video Identification Code	Quantum Data format
3	480p59SH, 480p60SH
4	720p59, 720p60
5	1080i29, 1080i30
6	480i2x29, 480i2x30, 480i2xL1, 480i2xL2
7	480i2xS1, 480i2xS2
8	240p2x_1, 240p2x_2, 240p2x_3, 240p2x_4, 240p2xL1, 240p2xL2, 240p2xL3, 240p2xL4
9	240p2xS1, 240p2xS4, 240p2xS3, 240p2xS4
10	480i4x29, 480i4x30, 480i4xL1, 480i4xL2
11	480i4xS1, 480i4xS2
12	240p4x_1, 240p4x_2, 240p4x_3, 240p4x_4, 240p4xL1, 240p4xL2, 240p4xL3, 240p4xL4
13	240p4xS1, 240p4xS2, 240p4xS3, 240p4xS4
14	480p2x59, 480p2x60, 480p2xL1, 480p2xL2
15	480p2xS1, 480p2xS2
16	1080p59, 1080p60
17	576p50, 576p50LH
18	576p50SH
19	720p50
20	1080i25
21	576i2x25, 576i2xLH
22	576i2xSH
23	288p2x_1, 288p2x_2, 288p2x_3, 288p2xL1, 288p2xL2, 288p2xL3
24	288p2xS1, 288p2xS2, 288p2xS3
25	576i4x25, 576i4xLH
26	576i4xSH
27	288p4x_1, 288p4x_2, 288p4x_3, 288p4xL1, 288p4xL2, 288p4xL3
28	288p4xS1, 288p4xS2, 288p4xS3
29	576p2x50, 576p2xLH
30	576p2xSH
31	1080p50
32	1080p23, 1080p24

EIA/CEA-861-E Video Identification Code	Quantum Data format
33	1080p25
34	1080p29, 1080p30
35	480p4xL1, 480p4xL2, 480p4x59, 480p4x60
36	480p4xS1, 480p4xS2
37	576p4xLH, 576p4x50
38	576p4xSH
39	1080i25_
40	1080i50
41	720p100
42	576p100, 576p100L
43	576p100S
44	576i2x50, 576i2xL1
45	576i2xS1
46	1080i59, 1080i60
47	720p119, 720p120
48	480p119L, 480p120L, 480p119, 480p120
49	480p119S, 480p120S
50	480i2xL3, 480i2xL4, 480i2x59, 480i2x60
51	480i2xS3, 480i2xS4
52	576p200, 576p200L
53	576p200S
54	576i2x_1, 576i2xL2
55	576i2xS2
56	480p239, 480p240, 480p239L, 480p240L
57	480p239S, 480p240S
58	480i2x_1, 480i2x_2, 480i2xL5, 480i2xL6
59	480i2xS5, 480i2xS6
60	720p24
61	720p25
62	720p30
63	1080p120 (not supported by 882)
64	1080p100 (not supported by 882)

Image selection

Once you have determined the formats appropriate for testing HDMI displays, you will apply a series of images suitable for evaluating the display. For digital fixed pixel displays, you typically want to select images to test for pixel anomalies, photometry, luminance, centering, resolution, and persistence.

Each image in the 882's library is intended to test one or more attributes of a particular display type and video type.

Note: You can also create your own images. See [“Creating custom images”](#) on page 234 for details.

The table below provides a summary of display characteristics and the images used to evaluate them.

Display type	Display test	Recommended images
Digital flat panel (fixed pixel display)	Pixel anomalies (stuck pixels, misc sampling)	Flat, Raster, Ramp_B, Ramp_G, and Ramp_R, Focus_@6, Focus_@7, Focus_@8, Focus_@9, Text_9, Text_9T, Text_11, Text_12T, Text_16
	Photometry (chrominance, contrast, levels)	Flat, Flat07, Flat13, Flat20, Flat27, Flat33, Flat40, Flat47, Flat53, Flat60, Flat67, Flat73, Flat80, Flat87, Flat93, FlatGray, Flat_01, Flat_02, Flat_03, Flat_04, Flat_05, Flat_06, Flat_07, Flat_08, Flat_09, Flat_10, Flat_11, Flat_12, Flat_13, Flat_14, Flat_15, Flat_16, Ramp_B, Ramp_G, and Ramp_R, ColorBar, SMPTEbar, SMPTE133
	Luminance	SMPTE133 (grayscale), Grays5, Grays9, Grays11, Grays16, Grays32, Grays64
	Centering	Outline0, Outline1, Outline2, Outline3
	Resolution	BurstTCE, Grill_11, Grill_15, Grill_22, Grill_33, Grill_44
	Persistence	Animated images: Persist, Cubes, SlideX
	Deep Color (882E only)	Ramp12, RampDif, Checkers
	3D (882E only)	3DCRTK, 3DCUBES, custom bitmap images

Setting up the 882 for HDMI testing

This section provides general procedures for setting up the 882 for HDMI testing. The procedures below can be performed using the front panel or the command line interface.

To set up the 882 for HDMI testing:

1. Connect an HDMI-to-HDMI cable between the HDMI display device under test and the either one of the HDMI OUT connectors on the 882.
2. Activate the HDMI-H interface on the output port:
 - a. Press the **Interface** key to access the list of interfaces. A listing of signal interfaces appears on the 882's display as shown below.

* VGA	CVBS
HDMI-D	S-VIDEO
HDMI-H	SDI

- b. Choose the **HDMI-H** item by pressing the adjacent soft key.

The interface is activated and the port outputs the currently selected image and format.

VGA	CVBS
HDMI-D	S-VIDEO
*HDMI-H	SDI

Alternatively, to select the interface through the command line, enter the following commands:

```
XVSI 4 // Selects the HDMI-H interface
ALLU // Applies the interface setting to the 882
```

3. (Optional) Disable the second HDMI output:
 - a. Press the **Options** key. The following information appears on the 882's display.

+Output	Mark #1-
	Disable 2-

- b. Disable the second output by pressing the soft key adjacent to the Disable 2 option. A + appears next to Disable 2 option, indicating it is enabled.

4. (Optional) Add an identification mark on the monitor of the HDMI output number 1.
 - a. Press the **Options** key. The following information appears on the 882's display.

+Output	Mark #1-
	Disable 2-

- b. Add an identification mark on the monitor connected to the HDMI output 1 by pressing the soft key adjacent to the Mark #1 option. A + appears next to Mark #1 option, indicating it is enabled.

A small colored patch appears on the upper right of the display connected to HDMI output 1.

To verify the test set-up:

1. Press the **Source** key to access the list of formats.
2. Choose a standard format (for example, DMT0660) by pressing the adjacent soft key.

Alternatively, you can load the format with the following command:

```
FMTL DMT0660  
FMTU
```

3. Press the **Content** key to access the list of images.
 4. Choose a suitable image (for example, ColorBar) by pressing the adjacent soft key.

Alternatively, you can load the image with the following command:

```
IMGL ColorBar  
IMGU
```

5. Verify that the image appears on the display under test.

Selecting video format

Once you have selected the interface type for the display under test, you need to select a video output format. A format defines a set of video, timing, and sync parameters for a specific device or standard. This section explains how to configure the 882 to output video formats that are supported by the display under test.

Important: *If the display under test has not implemented hot plug correctly, you will have to bypass hot plug detection in the 882 to enable video output. See below for procedure on bypassing hot plug detection.*

Note: *For more information about formats, see Chapter 6, “Working with Formats.”*

Setting Source list of formats

The 882 provides a Source list of standard (pre-defined) formats. The Source list can be set automatically when connecting to a EDID-compatible display. Otherwise, you can manually set which formats are listed.

To automatically set Source list of formats for EDID-compatible display:

When testing EDID-compatible displays, the 882 can automatically update the Source list to include only formats supported by the display under test. To do this:

1. Connect the 882 to the display you want to test.
2. Press the **Sink** key. The following information appears on the 882's display.

```
Manufacturer:SNY
Product Code:144
Serial#:7011007
week:20 Year:1998
```

3. Press the **Options** key. The following information appears on the 882's display.

```
-EDID Formats      CDF ⏏
+HP Bypass
-Emulate
```

4. Choose the **EDID Formats** item by pressing the adjacent soft key. A + appears next to EDID Formats indicating enabled.

The 882 loads the Source list with formats supported by the connected display (hot-plug formats read via EDID structure of attached display).

5. To redisplay all formats, press the soft key adjacent to EDID Formats. A '-' (minus sign) next to EDID Formats indicates it is disabled.

To bypass hot plug detection:

If the display under test has not implemented hot plug correctly, you will have to bypass hot plug detection in the 882 to enable video output.

1. Connect the 882 to the display you want to test.
2. Press the **Sink** key. The following information appears on the 882's display.

```
Manufacturer:SNY
Product Code:144
Serial#:7011007
week:20 Year:1998
```

3. Press the **Options** key. The following information appears on the 882's display.

```
-EDID Formats      CDF ⌘  
+HP Bypass  
-Emulate
```

4. Choose the **HP Bypass** (hot plug bypass) item by pressing the adjacent soft key. A + appears next to HP Bypass indicating enabled.

To manually set Source list of formats for non-EDID-compatible display:

When testing a display that is not EDID-compliant, the Source list is filtered to display only those formats suitable for a particular interface type. For example, if you select CVBS, the Source list does not include the VESA formats.

The 882's format library is comprised of a set of format catalogs. You can set up the 882 to show only the formats you want, in the order you want, when you browse through the Source list. See "[Format catalogs](#)" on page 223 for details.

To use Emulate mode:

Emulate mode automatically sets color space, synchronization type, and other settings based on the interface and format selected:

- For VGA interface, synchronization type and color space are automatically set and are not changeable.
- For HDMI interface, synchronization type and color space are automatically set, but color space can be changed.

1. Connect the 882 to the display you want to test.
2. Press the **Sink** key. The following information appears on the 882's display.

```
Manufacturer:SNY  
Product Code:144  
Serial#:7011007  
Week:20 Year:1998
```

3. Press the **Options** key. The following information appears on the 882's display.

```
-EDID Formats      CDF ⌘  
+HP Bypass  
-Emulate
```

4. Choose the **Emulate** item by pressing the adjacent soft key. A + appears next to Emulate indicating enabled.

Alternatively, to select the emulate mode through the command line interface, enter the command shown below:

```
EMUG 1 // Enables emulate mode
```

To disable the emulate mode through the command line interface, enter the command shown below:

```
EMUG 0 // Disables emulate mode
```

Selecting a format

From the Source list of formats, you select the video format output for your display under test.

To select a format:

1. Identify the type of display (composite television, component standard definition television, component high definition television, computer equipment, or other specialty display).

Note: The 882 has a library of standard formats. For a description of how the library is organized, see [“Understanding the format library”](#) on page 46.

2. For non-EDID compliant displays, check the specifications of your display for supported formats.
3. Press the **Source** key to access the list of formats. A list of formats appears on the 882’s display as shown below. To see all of the formats, press the + and - keys.

*DMT0660	DMT0672
DMT0675	DMT0685
DMT0785H	DMT0856
DMT0860	DMT0872

Note: The list of formats displays when pressing the **Source** key may be a filtered or abbreviated list. Formats not suitable for the selected interface type will not appear by default on the **Source** list. Also, you can disable format catalogs to prevent certain formats from appearing on the Source list. For more information about format catalogs, see [“Format catalogs”](#) on page 223.

4. Choose a format by pressing the adjacent soft key.

Upon selecting a format, you can modify the format options and settings if necessary. For instructions on this, see [“Configuring format parameters”](#) on page 177.

Testing HDMI displays

This section provides procedures for testing HDMI displays. The procedures below can be performed using the front panel or the command line interface.

To test HDMI displays:

1. Set up the 882 for HDMI output. See “[Setting up the 882 for HDMI testing](#)” on page 271.
2. Press the **Source** key and select the first test format.

Alternatively, you can load the format with the following command:

```
FMTL format_name  
FMTU
```

3. Press the **Content** key and select the first test image. For digital fixed pixel displays, you typically want to select images to test for pixel anomalies, photometry, luminance, centering, resolution, and persistence. For more details on what images test these specific display attributes, see “[Image selection](#)” on page 270 or Appendix B, “[Image Reference](#).”

Alternatively, you can load the image with the following command:

```
IMGL image_name  
IMGU
```

4. Repeat steps 1 and 2 for all formats and test images.

Note: You can customize your 882 to run through a specified set of formats and images automatically or manually by creating test sequences. See “[Creating a test sequence](#)” on page 256.

Use the following guidelines to verify proper operation:

- When testing photometry such as chrominance, use the [ColorBar](#), [SMPTE133](#), or [SMPTEbar](#) images. Look for missing bars which may indicate a dead or unconnected channel. Also, look at the transitions between the bars; they should be sharp and distinct. Each bar also should be uniform in color and intensity across its entire width.
- To test luminance, you can use the [SMPTE133](#) (grayscale) images. To test gamma correction, you can use the [SMPTE133](#) (checkbox) image. The detailed methods for verifying these parameters on the [SMPTE133](#) image are provided in Appendix B, “[Image Reference](#).”
- When testing for centering, use the Outline images. The detailed methods for verifying centering with the Outline images ([Outline0](#), [Outline1](#), [Outline2](#), [Outline3](#)) are provided in Appendix B, “[Image Reference](#).”
- When testing resolution with the Grill images, you should be able to see individual and distinct stripes in all areas of the display at all four resolutions.

- When testing for pixel anomalies, use the Flat, Raster, and Ramp images. Use the Raster and Flat images to look for pixels that may be stuck on or off, respectively. The luminance should increase uniformly for the Ramp image. Also look for sparkles indicating problems with sampling.
- When testing for persistence with the animated images ([Cubes](#) and [Persist](#)), look for bleeding or trails in the wake of the moving object.

Testing HDMI 1.4 displays with 3D

This section provides procedures for testing HDMI 1.4 3D displays. The 3D feature is available on all versions of the 88x series. The 3D feature enables you to test the ability of your 3D capable HDTV to process HDMI vendor specific infoframes with 3D metadata and to render 3D formats. The 3D feature can test 3D using the following timings (resolutions):

- 480p60, 576p59
- 720p60, 720p59, 720p50
- 1080p23, 1080p24

The 3D feature can test the following 3D structures:

- Frame packing
- Line alternative
- Side-by-side (full) (not supported by the 882EA)
- Side-by-side (half)
- Top and Bottom

Note: *The 3D feature is available on all versions of the 88x series.*

Rendering 3D images

This section provides detailed procedures for rendering 3D images.

Prerequisites for testing with the 3D images

In order to use the 3D utility to test your display you will need to ensure that the following prerequisites are met:

- Upgrade your 88x to the current release. Read the Release Notes to verify which release supports the 3D images.
- Locate the Quantum Data 3D bitmaps or use your own 3D bitmaps – The Quantum Data bitmaps are available from the Quantum Data website at:
- http://www.quantumdata.com/apps/3D/sample_BMP.asp.
- (optional) If you wish to create your own 3D bitmaps from stereoscopic image pairs that you have, then you will need to acquire the Quantum Data Bitmap Conversion Tool. This tool enables you to create 3D ready images that use various 3D format structures from existing stereographic bitmaps (left and right eye views). This utility is available at the Quantum Data downloads page: www.quantumdata.com/downloads/. You do not need this tool if you already have 3D bitmap test images or if you want to use the Quantum Data 3D bitmaps.

- Load the 3D ready bitmap images onto the compact flash card in the 88x slot using the FTP Browser utility.

Workflow for rendering 3D images

The following describes the workflow for testing using the 882 Quantum Data 3D utility. This workflow assumes that you have satisfied the pre-requisites described above.

- Select a valid 3D timing (format) through 88x front panel in Basic mode or through the command line.
- Specify the 3D format structure.
- Select the 3D ready bitmap test image either through the 88x front panel using the Browse mode or the command line.

Creating 3D ready images

Use the following procedures to create the 3D ready images from two stereographic bitmaps using the Quantum Data 3D Bitmap Conversion Tool.

Note: *If you have your own 3D bitmap images or if you are using the bitmap images provided by Quantum Data, you do not need to use this procedure.*

1. Acquire 3D stereographic image pairs (left and right) and place them in a convenient directory in your PC.
2. Download the Quantum Data 3D Bitmap Conversion Tool available from the Quantum Data website at: www.quantumdata.com/downloads/. Unzip the file and place it in a convenient location on your PC. This tool will convert a pair of 3D stereographic image pairs into a 3D bitmap of a specific 3D format that you can use in your 882.
3. Launch the Bitmap Conversion Tool by double clicking on the application icon. The application opens as shown below:

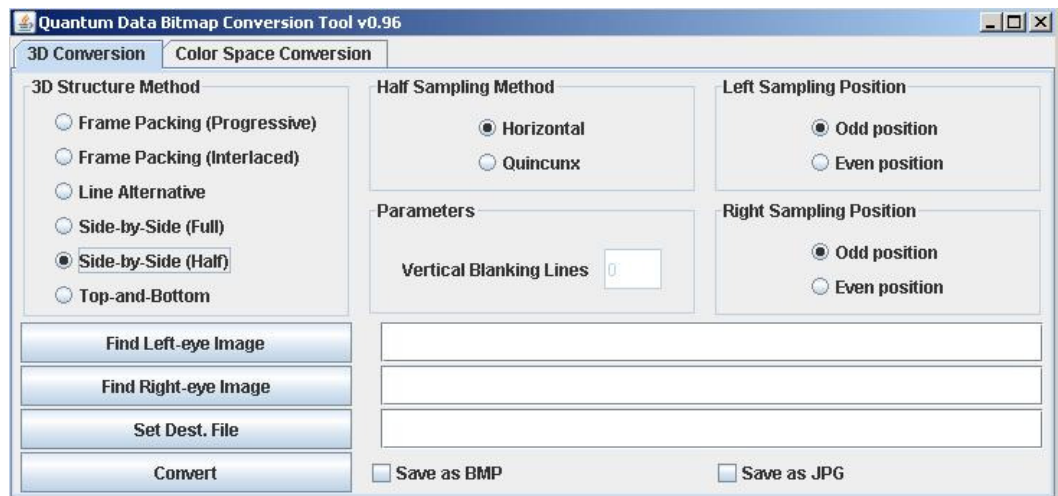

4. Load the left eye image residing on your PC by clicking on the Find Left-eye Image activation button. When you select the image, it will appear in the first entry field under the list of parameters just to the right of the Find Left-eye Image activation button.
5. Load the right eye image residing on your PC by clicking on the Find Right-eye Image activation button. When you select the image, it will appear in the second entry field under the list of parameters just to the left of the Find Right-eye Image activation button.
6. Select the desired 3D Structure Method using the radio buttons. The following table lists the various methods and the settings associated with them:

The following table describes the 3D Structure Methods and Parameters.

3D Structure Method	Half Sampling Method	Left Sampling Position	Parameter - Vertical Blanking Lines	Right Sampling Position
Frame Packing	Not applicable	Not applicable	The number of lines between the left and right eye image - typically set to 30 lines for 720 timings and 45 lines for 1080 timings	Not applicable
Field Alternative	Not applicable	Not applicable	The number of lines between the left and right eye image - typically set to 30 lines for 720 timings and 45 lines for 1080 timings	Not applicable
Line Alternative	Not applicable	Not applicable	Not applicable	Not applicable
Top and Bottom	Not applicable	Not applicable	Not applicable	Not applicable
Side by Side (full)	Not applicable	Not applicable	Not applicable	Not applicable
Side by Side (half)	One of: - Horizontal - Quincunx	One of: - Odd position - Even position	Not applicable	One of: - Odd position - Even position

7. Set the name and directory where the resulting 3D ready image will be stored using the Set Dest. File activation button. When you select the name and directory, it will appear in the third entry field under the list of parameters.

Note: It is important to use a naming convention that identifies the format resolution of the image including the frame rate and the 3D structure. You are limited to using only 8 characters which is all that can be shown in the 88x front panel LCD. For example you could use a naming convention as follows:

- FFFF are four characters for the number of lines in the format timing, typically either 0720 for 720 or 1080 for 1080.

- DDDD are four characters for the 3D structure used. Either:
 - TP for Top and Bottom
 - FP for Frame Packing
 - LALT for Line Alternative
 - SBSF for Side-by-Side (Full)
 - HHEE for Side-by-Side (Half) Horizontal sub-sampling Even left, Even right
 - HHEO for Side-by-Side (Half) Horizontal sub-sampling Even left, Odd right
 - HHOE for Side-by-Side (Half) Horizontal sub-sampling Odd left, Even right
 - HHOO for Side-by-Side (Half) Horizontal sub-sampling Odd left, Odd right
 - HQEE for Side-by-Side (Half) Quincunx matrix Even left, Even right
 - HQEO for Side-by-Side (Half) Quincunx matrix Even left, Odd right
 - HQOE for Side-by-Side (Half) Quincunx matrix Odd left, Even right
 - HQOO for Side-by-Side (Half) Quincunx matrix Odd left, Odd right

For example: 1080HQEO would represent a 1080p format using the Side-by-Side structure using Quincunx matrix with Even left eye and Odd right eye.

8. Specify whether you want to save the resulting 3D ready image as a bitmap (BMP) using the checkbox provided. JPEG is not recommended.
9. Click on the Convert activation button to make the conversion and save the file in the specified directory using the specified name.

Rendering 3D ready images

Use the following procedures to render the 3D ready images with your 88x.

1. Place a compact flash card into the 88x slot provided.
2. Transfer the 3D ready images from your PC to the compact flash card using the 88x FTP Browser utility. On the Instrument Field side of the FTP Browser, navigate to the

card0/library/UserData directory, and then transfer the files from your Host Files on the PC to the Instrument Files. Refer to the following screen.

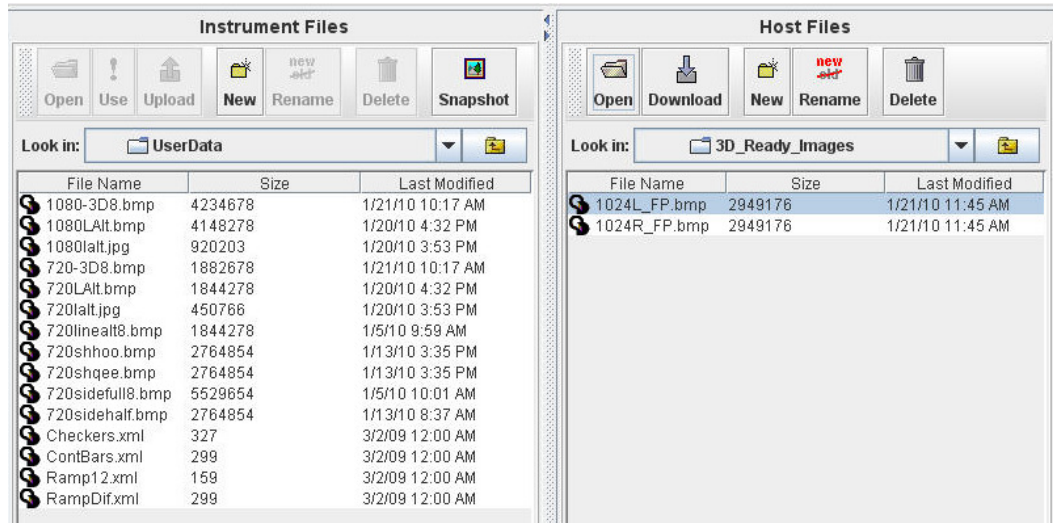

3. Select the format from the 88x using either the front panel or the command line.

To load the format through the front panel:

- a. Press the Source button and then select the format. Be sure and select the format that is associated with the 3D ready bitmap image you are intending to render. Note that the 88x should be in the Basic mode when you select the format.
- b. Press the Options button repeatedly until the 3D menu appears. Select the desired 3D Structure as shown below:

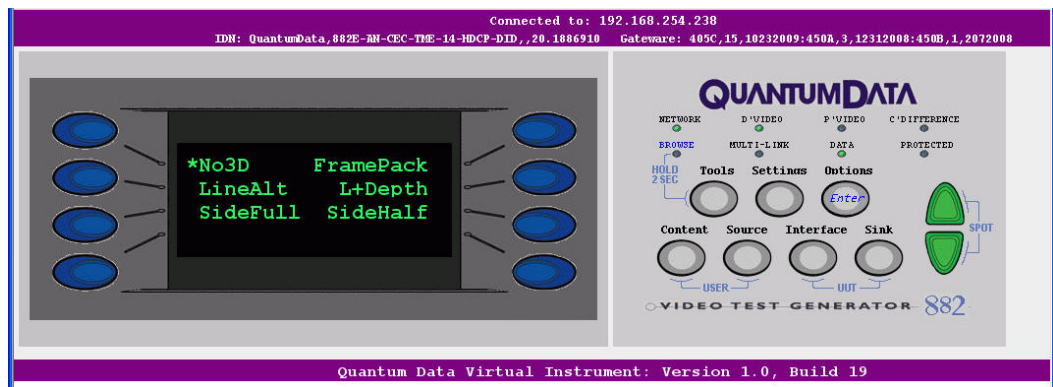

To load the format through the command line. Enter the following commands (example only):

```
FMTL 720p20
X3DM 1 0 // Use the table below to determine what values to enter
FMTU
```

The following table describes the X3DM Command Parameters.

Parameter No.	Descriptions	Value Permitted
1	Enable or disable 3D	0 - Disable 1 - Enable
2	3D Method	0 - Frame Packing 2 - Line Alternative 3 - Side by Side (Full) 4 - L + Depth 6 - Top and Bottom 8 - Side by Side (Half)
3	Applies to Side by Side (half) only	Horizontal Sub-Sampling: 0 - Odd/Left picture, Odd/Right picture 1 - Odd/Left picture, Even/Right picture 2 - Odd/Left picture, Odd/Right picture 3 - Odd/Left picture, Even/Right picture Quincunx Matrix: 4 - Odd/Left picture, Odd/Right picture 5 - Odd/Left picture, Even/Right picture 6 - Odd/Left picture, Odd/Right picture 7 - Odd/Left picture, Even/Right picture

Examples:

```
X3DM 1 0 // enables 3D, sends Frame Packing
X3DM 1 8 3 // enables 3D, sends side by side using Even/Left
           picture, Even/Right picture horizontal subsampling
X3DM 0 // disables 3D
```

4. Select the 3D ready image from the 88x using either the front panel or the command line:

Using the Front Panel

- a. Put the 88x into the Browse mode. To use the Browse mode hold the Tools key down
- b. until you see an indication on the LCD that the 88x has activated the Browse mode.
- c. Select PCCard and then navigate to the Library/UserData directory
- d. Select the 3D ready image using the blue button adjacent to the desired 3D ready image in the list. Return to the Basic mode after making your selection.

When you select a 3D capable format and 3D ready image, the 88x transmits the image out the HDMI output port and also sends the HDMI vendor specific infoframe with the necessary 3D metadata.

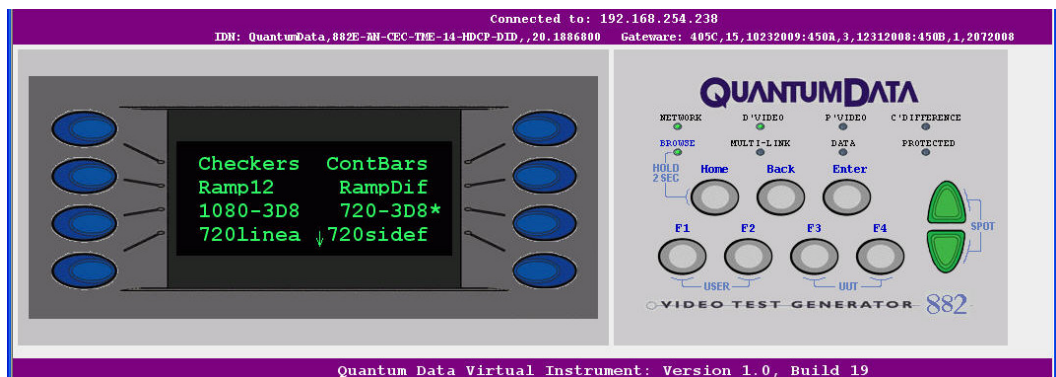

Using the command line:

- e. Enter the following command to load the 3D ready image:

```
IMGL /card0/library/UserData/720-3D8.bmp  
IMGU
```

Testing HDMI video pixel repetition (882 only)

The EIA/CEA-861-B standard defines a number of progressively-scanned gaming formats which support variable horizontal resolutions. These formats maintain a fixed 2880-pixel format timing and use pixel repetition to provide 10 different effective horizontal resolutions. A special blanking scheme further reduces the number of active pixels (to those listed in the table below), thereby providing a horizontal safe area that insures that all of the pixels in a game will be visible on overscanned HDMI displays.

Note: *This feature is not supported on the 881 generator.*

To support HDMI gaming format and pixel repetition testing, the 882 allows you to sequentially apply pixel repetition (up to 10 times) to a unique image. As the pixel repetition factor is increased, the horizontal resolution of the displayed image will decrease as shown in the table below.

Pixel repetition factor (image version)	Horizontal resolution
0	2880 pixels/line
1	2560 pixels/line
2	1280 pixels/line
3	853 pixels/line
4	640 pixels/line
5	512 pixels/line
6	427 pixels/line
7	366 pixels/line
8	320 pixels/line
9	284 pixels/line
10	256 pixels/line

To test HDMI video pixel repetition:

1. Set up the 882 for HDMI output. See [“Setting up the 882 for HDMI testing”](#) on page 271.

2. If you have auto configured the formats through the EDID you may have to disable this feature as follows:

a. Press the **Sink** key. The following information appears on the 882's display.

```
Manufacturer:SNY
Product Code:144
Serial#:7011007
week:20 Year:1998
```

b. Press the **Options** key. The following information appears on the 882's display.

```
-EDID Formats      CDF ↵
+HP Bypass
-Emulate
```

c. Choose not to **EDID Formats** by pressing the adjacent soft key. A - appears next to EDID Formats, indicating it is disabled.

3. Press the **Source** key and select the first test format.

Note: Gaming formats on the 882 have the characters "4x" in their names (such as "480i4x29" or "576i4x25"). For a listing of all HDMI formats, see the table on page 267. If you have auto configured the formats through the EDID you may have to disable this feature.

Alternatively, to select the format through the command line interface, enter the following commands:

```
FMTF /tffs0/Library/Formats // Set format path to 882 memory
FMTL 480i4x29                // Loads the 480i4x29 format
FMTU                          // Activates the 480i4x29 format
```

4. Press the **Content** key and choose the PixelRep image by pressing the adjacent soft key. The PixelRep image appears on the HDMI display.

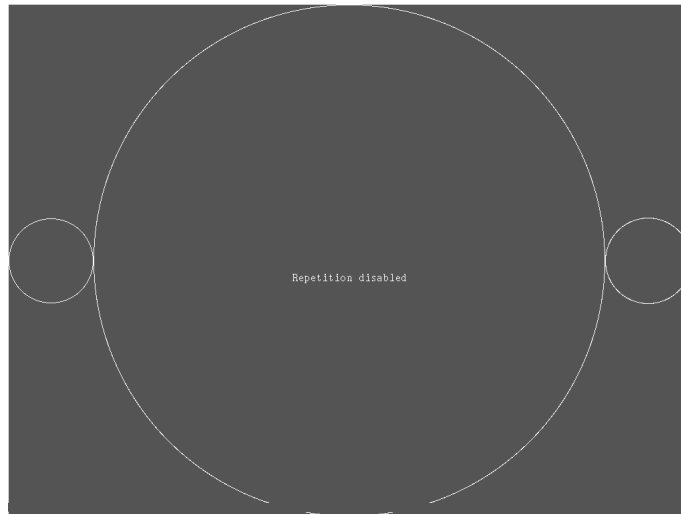

Alternatively, to select the PixelRep image using the command line interface, enter the following commands:

```

IMGP /tffs0/Library/Images // Set image path to 882 memory
IMGL PIXELREP // Loads the PixelRep image
IMGU // Activates the PixelRep image

```

5. Enable and view image versions for the PixelRep image as follows:

- a. Press the **Options** key. The following menu appears on the 882's display:

-More	
	Red+
-NoGamma	Green+
-Noise	Blue+

- b. Choose the **More** item by pressing the adjacent soft key until a + and Rendition appears next to the item.

+More	Rendition: 000
	Red+
-NoGamma	Green+
-Noise	Blue+

- c. Press the + and - keys to advance through the image versions.

Alternatively, to enable and view image versions using the command line interface, enter the following commands:

```

ISUB 1 // Enables sub images
IVER 1 // Specifies the first image version

```

```
IMGU // Activates the image version
```

The pixel repetition factor appears in the center of the image. For instance, the image displaying a pixel repetition factor of 4 (“Sent 4”) is shown in the example below.

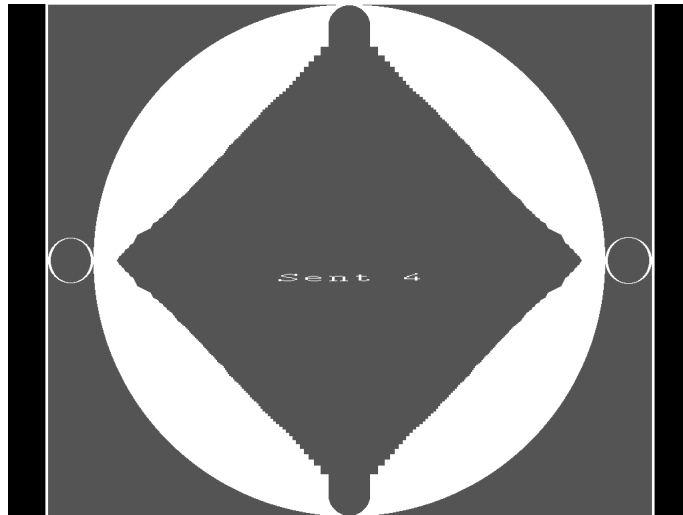

6. To verify proper handling of the selected HDMI gaming format, check the following in the image on the HDMI display:
 - The horizontal active area is resized to the appropriate number of clocked pixels using vertical bars to the left and right of the default (2880 pixel) image.
 - The white vertical borders and circles in the active area appear thicker.
 - The white text in the center of the active area appears stretched and bigger.
7. Select additional pixel repetition factors (as desired) to verify proper handling of the selected HDMI gaming format using variable horizontal resolutions.
8. When testing is complete, disable image versions by pressing the **Options** key and choosing **More** until a - appears next to it.

Alternatively, to disable image versions using the command line interface, enter the following command:

```
ISUB 0 // Disables sub images
```

9. To test another HDMI gaming format, return to step 3.

Testing HDMI audio

This section provides steps on how to test handling of audio packets by an HDMI display. Testing can be performed using audio originating from both internal (882) and external sources. The 882 supports both 2-channel SPDIF audio from internal source and external source and up to 8-channel audio from an internal audio source. There are separate sets of images for testing 2-channel SPDIF audio and 8-channel audio.

The procedures describe how you can vary the audio amplitude, audio frequency and audio sampling rate for 2-channel or 8-channel audio. Note that there are some limitations for the 8-channel audio at high sampling rates these are described below.

Testing 2-channel HDMI audio output from internal SPDIF source

To support testing of HDMI audio, the 882 provides two-channel LPCM audio (using an internally-generated sinewave) at the highest audio sampling rate (48 kHz). Multiple scenarios are provided that allow you to test one or both audio channels at different amplitudes and frequencies, as well as test using the different supported sampling rates. The sampling rate for all channels is completed through a single image (AudioRAT).

The following table lists the images used to perform HDMI audio testing using an internal audio source.

Image	Description
AudioLR	Left and right audio channel output with adjustable amplitude.
AudioLRf	Left and right audio channel output with adjustable frequency.
AudioRAT	Left and right audio channel output with adjustable sampling rate.
Audio_L	Left audio channel output with adjustable amplitude.
Audio_Lf	Left audio channel output with adjustable frequency.
Audio_R	Right audio channel output with adjustable amplitude.
Audio_Rf	Right audio channel output with adjustable frequency.

To test an HDMI display using HDMI audio from the 882:

1. Set up the 882 for HDMI output. See [“Setting up the 882 for HDMI testing”](#) on page 271.
2. Press the **Source** key and select the first test format (either DMT0660 or 480i2x29).

Alternatively, to select the format using the command line interface, enter the following commands:

```
FMTF /tffs0/Library/Formats // Set format path to 882 memory
FMTL 480i2x29 // Loads the 480i2x29 format
FMTU // Activates the 480i2x29 format
```

3. Press the **Content** key and choose an audio image (for example, AudioLR).

The selected image appears on the connected HDMI display. The image shows the current settings for the HDMI audio output. For example, the AudioLR image is shown below.

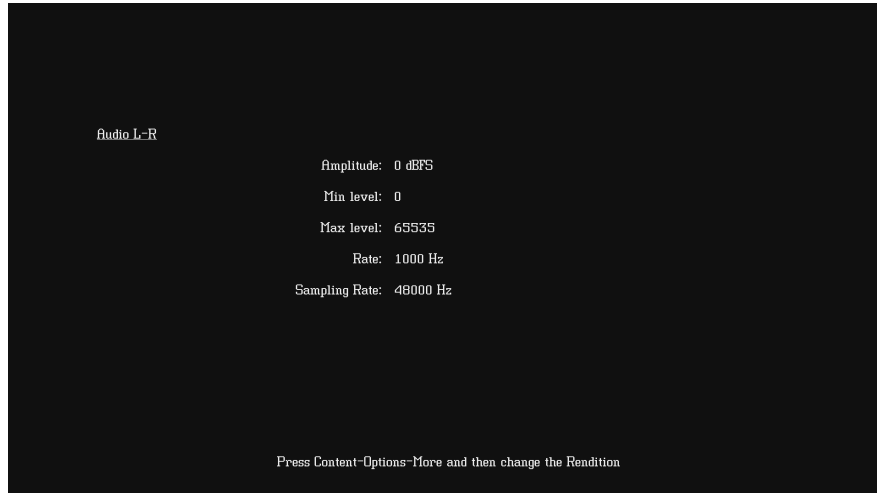

Alternatively, to select the audio image using the command line interface, enter the following commands:

```
IMGF /tffs0/Library/Images // Set image path to 882 memory
IMGL AUDIOLR // Loads the AudioLR image
IMGU // Activates the AudioLR image
```

4. Enable and view image versions for the AudioLR image as follows:

- a. Press the **Options** key. The following menu appears on the 882's display:



- b. Choose the **More** item by pressing the adjacent soft key until a + and Rendition appears next to the item.

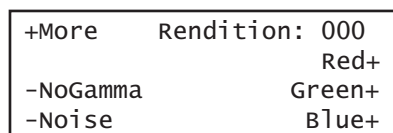

- c. Press the + and - keys to advance through the image versions.

Note: Depending on the selected image, pressing the + and - keys will change the amplitude or frequency of the HDMI audio output.

Alternatively, to enable and view an image version using the command line interface, enter the following commands:

```
ISUB 1 // Enables sub images
IVER 1 // Specifies the first image version
IMGU // Activates the image version
```

5. To verify proper HDMI audio handling, check the following on the HDMI display:

- Audio is output from the proper channels (left, right, or both).
- When amplitude is adjusted, the volume is subsequently changed.
- When frequency is adjusted, the pitch is subsequently changed.

6. When testing is complete, disable image versions by pressing the **Options** key and choosing **More** until a - appears next to it.

Alternatively, to disable image versions using the command line interface, enter the following command:

```
ISUB 0 // Disables sub images
```

7. Press the **Content** key and choose the AudioRAT image to test the sampling rate.

The AudioRAT image appears on the connected HDMI display. The image shows the current settings for the HDMI audio output. Note that the sampling rate image (AudioRAT) applies to all audio channel.

Alternatively, to select the AudioRAT image using the command line interface, enter the following commands:

```
IMGP /tffs0/Library/Images // Set image path to 882 memory
IMGL AUDIORAT // Loads the AudioRAT image
IMGU // Activates the AudioRAT image
```

8. Enable and view image versions for the AudioRAT image as follows:

a. Press the **Options** key. The following menu appears on the 882's display:

-More	
	Red+
-NoGamma	Green+
-Noise	Blue+

b. Choose the **More** item by pressing the adjacent soft key until a + and Rendition appears next to the item.

+More	Rendition: 000
	Red+
-NoGamma	Green+
-Noise	Blue+

c. Press the + and - keys to advance through the image versions to change the audio sampling rate.

Alternatively, to enable and view an image version using the command line interface, enter the following commands:

```
ISUB 1 // Enables sub images
```

```
IVER 1 // Specifies the first image version
IMGU // Activates the image version
```

9. To test another HDMI audio output type, repeat the procedure.

Testing 8-channel HDMI audio output from internal source

To support testing of HDMI audio, the 882 provides 8-channel LPCM audio (using an internally-generated sinewave) at the highest audio sampling rate (192 kHz). Multiple scenarios are provided that allow you to test all audio channels at different amplitudes and frequencies, as well as test using the different supported sampling rates. The sampling rate for all channels is completed through a single image (AudioRAT).

High audio sampling rates and channel counts may require additional bandwidth in the blanking intervals. The required additional blanking intervals may only be available with high definition formats for example 720p and 1080i. When outputting 8 channels, the audio sampling rate is only guaranteed to 96kHz and requires that you use a high definition format.

Only two channels are guaranteed at the 192kHz sampling rate. These two channels must be from the 882's internal sine wave 882 as the SPDIF input is only guaranteed to 96kHz.

Note also that your receiving device must support 8-channel audio.

The following table lists the images used to perform HDMI audio testing using an internal audio source for 8 channels.

Note: *Selecting any of the numbered images (for example, Audio_1, Audio_2, etc.) causes all other channels to be deactivated.*

Image	Description
Audio_1	Channel 1 output with adjustable amplitude.
Audio_1f	Channel 1 output with adjustable frequency.
Audio_2	Channel 2 output with adjustable amplitude.
Audio_2f	Channel 2 output with adjustable frequency.
Audio_3	Channel 3 output with adjustable amplitude.
Audio_3f	Channel 3 output with adjustable frequency.
Audio_4	Channel 4 output with adjustable amplitude.
Audio_4f	Channel 4 output with adjustable frequency.
Audio_5	Channel 5 output with adjustable amplitude.
Audio_5f	Channel 5 output with adjustable frequency.
Audio_6	Channel 6 output with adjustable amplitude.
Audio_6f	Channel 6 output with adjustable frequency.
Audio_7	Channel 7 output with adjustable amplitude.

Image	Description
Audio_7f	Channel 7 output with adjustable frequency.
Audio_8	Channel 8 output with adjustable amplitude.
Audio_8f	Channel 8 output with adjustable frequency.
Audio_X	All channels output with adjustable amplitude.
Audio_Xf	All channels output with adjustable frequency.

To test an HDMI display using HDMI 8-channel audio from the 882:

1. Set up the 882 for HDMI output. See “[Setting up the 882 for HDMI testing](#)” on page 271.
2. Press the **Source** key and select the first test format (for example: DMT0660 or 480i2x29).

Alternatively, to select the format using the command line interface, enter the following commands:

```
FMTF /tffs0/Library/Formats // Set format path to 882 memory
FMTL 480i2x29 // Loads the 480i2x29 format
FMTU // Activates the 480i2x29 format
```

3. Press the **Content** key and choose one of the audio images used for amplitude adjustment (for example, Audio_1).

The image appears on the connected HDMI display. The image shows the current settings for the HDMI audio output. For example, the Audio_1 image is shown below.

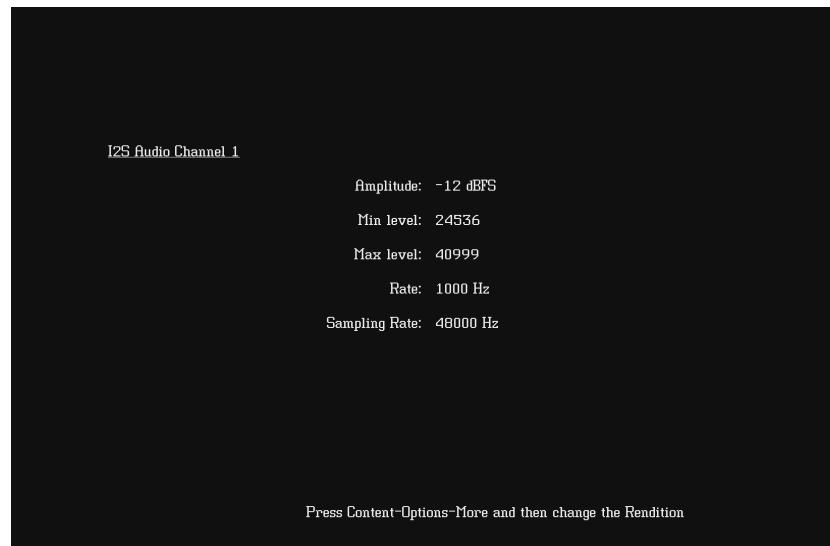

Alternatively, to select the audio image using the command line interface, enter the following commands:

```
IMGP /tffs0/Library/Images // Set image path to 882 memory
IMGL AUDIO_1 // Loads the Audio_1 image
IMGU // Activates the Audio_1 image
```

4. Enable and view image versions to modify the audio amplitude for the Audio_1 image as follows:

a. Press the **Options** key. The following menu appears on the 882's display:

-More	
	Red+
-NoGamma	Green+
-Noise	Blue+

b. Choose the **More** item by pressing the adjacent soft key until a + and Rendition appears next to the item.

+More	Rendition: 000
	Red+
-NoGamma	Green+
-Noise	Blue+

c. Press the + and - keys to advance through the image versions to change the audio intensity.

Note: Depending on the selected image, pressing the + and - keys will change the amplitude or frequency of the HDMI audio output.

Alternatively, to enable and view an image version using the command line interface, enter the following commands:

```
ISUB 1 // Enables sub images
IVER 1 // Specifies the first image version
IMGU // Activates the image version
```

5. To verify proper HDMI audio handling, check the following on the HDMI display:

- Audio is output from the proper channels (left, right, or both).
- When amplitude is adjusted, the volume is subsequently changed.

6. Press the **Content** key and choose one of the audio images used for frequency adjustment (for example, Audio_1f).

The image appears on the connected HDMI display. The image shows the current settings for the HDMI audio output. For example, the Audio_1f image is shown below.

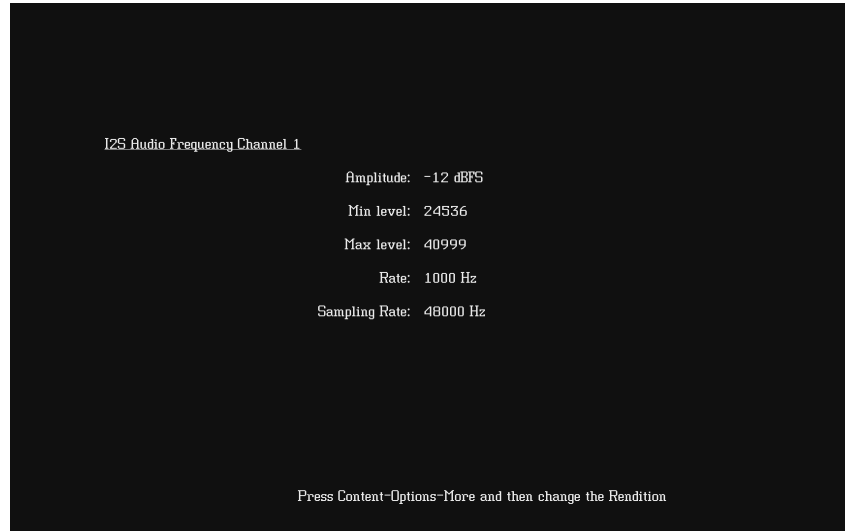

Alternatively, to select the audio image using the command line interface, enter the following commands:

```
IMGP /tffs0/Library/Images // Set image path to 882 memory
IMGL AUDIO_1f // Loads the Audio_1f image
IMGU // Activates the Audio_1f image
```

7. To verify proper HDMI audio handling, check the following on the HDMI display:

- Audio is output from the proper channels (left, right, or both).
- When frequency is adjusted, the pitch is subsequently changed.

8. Press the **Content** key and choose the AudioRAT image to test the sampling rate.

The AudioRAT image appears and shows the current settings for the HDMI audio output. Note that the sampling rate image (AudioRAT) adjusts the sampling rate for all audio images.

Alternatively, to select the AudioRAT image using the command line interface, enter the following commands:

```
IMGP /tffs0/Library/Images // Set image path to 882 memory
IMGL AUDIORAT // Loads the AudioRAT image
IMGU // Activates the AudioRAT image
```

9. Enable and view image versions for the AudioRAT image as follows:
 - a. Press the **Options** key. The following menu appears on the 882's display:

-More	Red+
-NoGamma	Green+
-Noise	Blue+

- b. Choose the **More** item by pressing the adjacent soft key until a + and Rendition appears next to the item.

+More	Rendition: 000
	Red+
-NoGamma	Green+
-Noise	Blue+

- c. Press the + and - keys to advance through the image versions to change the audio sampling rate.

Alternatively, to enable and view an image version using the command line interface, enter the following commands:

```
ISUB 1 // Enables sub images
IVER 1 // Specifies the first image version
IMGU // Activates the image version
```

10. When testing is complete, disable image versions by pressing the **Options** key and choosing **More** until a '-' (minus sign) appears next to it.

Alternatively, to disable image versions using the command line interface, enter the following command:

```
ISUB 0 // Disables sub images
```

11. To test another HDMI audio output channel or format, repeat the procedure.

Testing multi-channel compressed HDMI audio formats

The 882E instrument enables you to test HDMI compressed audio formats such as AC3, EAC3 and the HDMI 1.3 high bit rate lossless compressed audio such as Dolby TrueHD format. TrueHD's may carry up to 8 discrete audio channels, at a sample depth & rate of 24-bit/96 kHz (Blu-Ray Disc format specification allows also for encoding up to 6 channels at 192 kHz).

Multiple scenarios are provided that allow you to test all audio channels at different amplitudes and frequencies, as well as test using the different supported sampling rates. The sampling rate for all channels is completed through a single image (AudioRAT).

High audio sampling rates and channel counts may require additional bandwidth in the blanking intervals. The required additional blanking intervals may only be available with high definition formats for example 720p and 1080i. When outputting 8 channels, the audio sampling rate is only guaranteed to 96kHz and requires that you use a high definition format.

Only two channels are guaranteed at the 192kHz sampling rate. These two channels must be from the 882's internal sine wave 882 as the SPDIF input is only guaranteed to 96kHz.

Note: *Unlike the uncompressed formats (linear PCM) the compressed audio test signals are generated from a file. As a result the amplitude and frequency cannot be adjusted through the audio test images.*

To test compressed audio formats on an HDMI device from the 882:

1. Set up the 882 for HDMI output. See "[Setting up the 882 for HDMI testing](#)" on page 271.
2. Press the **Source** key and select the first test format (for example: 720p60).

Alternatively, to select the format using the command line interface, enter the following commands:

```
FMTF /tffs0/Library/Formats // Set format path to 882 memory
FMTL 720p60 // Loads the 720p60 format
FMTU // Activates the 720p60 format
```

- Press the **Content** key and choose the Dolby audio image as shown below. Note that you can also select the DTS image to access the DTS audio clips.

ComFocus	ContBars
Crosshtc	Cubes
DecodAdj	DecodeChk
Diamond1	Dolby*

The image appears on the connected HDMI display. The image shows the currently selected compressed audio format.

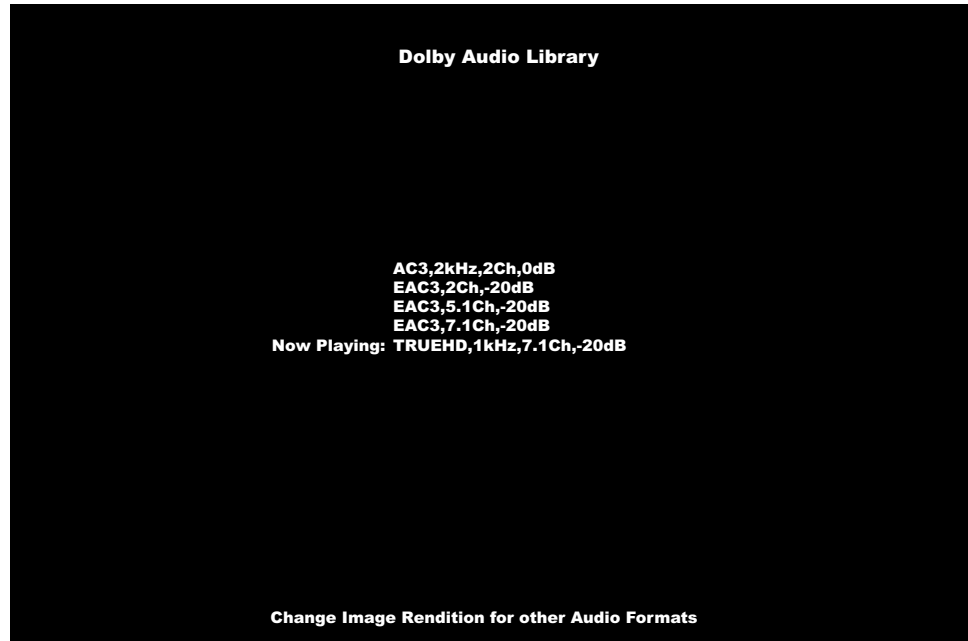

Alternatively, to select the Dolby image using the command line interface, enter the following commands:

```

IMGP /Cache0/Images           // Set image path to 882 memory
IMGL Dolby                     // Loads the Dolby image
IMGU                           // Activates the Dolby image
IMGL DTS                       // Loads the DTS image
IMGU                           // Activates the DTS image

```

Note: You can output compressed audio formats through the command line without selecting the Dolby image. To do this you enter the following command:

```

CAUD? // Queries for the list of stored compressed audio clip
       configurations:
1:DTS, 5.1, 48000.00 [dts-48kHz-1509kbps-51ch.wav.pcm]
2:DTS (ES), 6.1, 48000.00 [DTES-ES-48kHz-1509kbps-61ch.wav.pcm]
3:DTS (HDHRA), 7.1, 192000.00 [dtshdhra-48kHz-5376kbps-71ch.wav.pcm]
4:DTS (HDHRA), 5.1, 192000.00 [dtshdhra-48kHz-3840kbps-51ch.wav.pcm]
5:DTS (HDHRA), 7.1, 192000.00 [dtshdhra-96kHz-5760kbps-71ch.wav.pcm]
6:DTS (HDMA), 5.1, 192000.00 [dtshdma-48kHz-VBR-51ch-HDMI_HBR.ba.pcm]
7:DTS (HDMA), 7.1, 192000.00 [dtshdma-48kHz-VBR-71ch-HDMI_HBR.ba.pcm]

```

```

8:DOLBY(AC3), 2.0, 48000.00 [2khz2ch-0dB_ac3.pcm]
9:DOLBY(EAC3), 2.0, 192000.00 [1khz2ch-20dB_ec3.pcm]
10:DOLBY(EAC3), 5.1, 192000.00 [1khz51ch-20dB_ec3.pcm]
11:DOLBY(EAC3), 7.1, 192000.00 [1khz71ch-1frame_ec3.pcm]
12:DOLBY(TRUEHD), 7.1, 192000.00 [1khz71ch-20dB_mlp.pcm]
13:DOLBY(TRUEHD), 2.0, 192000.00 [nxt2ch2s.mlp.pcm]
CAUD 8 // Sends a 2 channel Dolby AC3 clip with 192kHz sampling rate
        at 0dB out the HDMI output.

```

4. Enable and view image versions to select the other audio formats as follows:
 - a. Press the **Options** key. The following menu appears on the 882's display:

-More	Red+
-NoGamma	Green+
-Noise	Blue+

- b. Choose the **More** item by pressing the adjacent soft key until a + and Rendition appears next to the item.

+More	Rendition: 000	Red+
-NoGamma		Green+
-Noise		Blue+

- c. Press the + and - keys to advance through the image versions to change the audio intensity.

Note: Depending on the selected image, pressing the + and - keys will change the amplitude or frequency of the HDMI audio output.

Alternatively, to enable and view an image version using the command line interface, enter the following commands:

```

ISUB 1 // Enables sub images
IVER 1 // Specifies the first image version
IMGU // Activates the image version

```

5. To verify proper HDMI audio handling, check the following on the HDMI display:
 - Audio is output from the proper channels (left, right, or both).
 - The proper audio format is shown on the Audio/Video receiver.

Testing HDMI audio using an external audio source

The 882 enables you to inject audio signals from an external SPDIF source (such as a DVD player) into the HDMI content stream. You can input IEC 61937 non-linear PCM encoded audio stream or compressed audio streams (for example AC-3 and DTS) into the SPDIF interface for output through the HDMI Tx connector.

To inject external audio into the HDMI stream:

- If you have the 882CA analyzer option you will have the VGA-to-RCA cable (part 30-00150). Connect the AV connector to the 882's SPDIF / AV port. Then connect the black RCA connector to the SPDIF output of the external audio source.

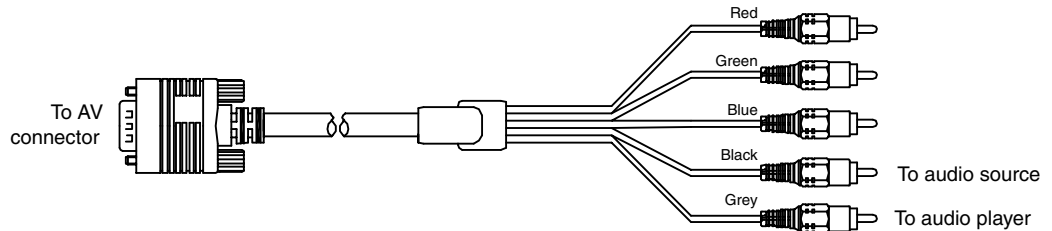

- If you have the 882C without the analyzer option, you will have the VGA-to-RCA cable (part 30-00148). Connect the AV connector to the 882's SPDIF / AV port. Then connect the red RCA connector to the SPDIF output of the external audio source.

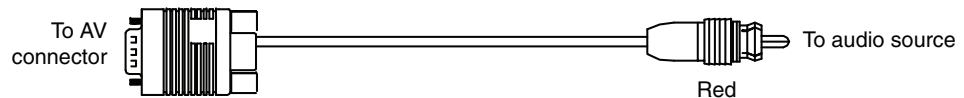

- If you have the 882E, you will have the (30-00123) BNC to RCA adapter (provided) so you will need a standard RCA cable. Simply connect the RCA cable from the SPDIF IN connect to the SPDIF output of the external audio source.

To test an HDMI display using HDMI audio from an external source:

1. Set up the 882 for HDMI output. See "[Setting up the 882 for HDMI testing](#)" on page 271.
2. Connect the external audio source to the SPDIF-A/V connector on the 882 as follows:
 - a. For the 882CA, using the RCA-to-VGA cable provided with the 882, connect the J1 connector to the SPDIF-A/V connector on the 882. Then connect the red RCA connector to the external audio source.
 - b. For the 882E, connect the external audio source to the SPDIF-A/V connector on the 882 using the BNC to RCA adapter provided with the 882.
3. Press the **Source** key and select a format suitable for the HDMI display (for example, DMT0660).

Alternatively, to select the format using the command line interface, enter the following commands:

```
FMTF /tffs0/Library/Formats // Set format path to 882 memory
FMTL DMT0660 // Loads the DMT0660 format
FMTU // Activates the DMT0660 format
```

4. Press the **Content** selection key and choose any image (for example, Master).

Alternatively, to select the image using the command line interface, enter the following commands:

```
IMGP /tffs0/Library/Images // Set image path to 882 memory
IMGL MASTER // Loads the Master image
IMGU // Activates the Master image
```

5. Configure the 882 to use an external audio source by entering the following commands:

```
SDMG 2
FMTU
```

6. Set the sample frequency to match the frequency of the external source by entering the following command:

```
ARAT 44.1E3 //(example only)
```

Alternatively, configure the 882 to detect the audio sampling rate from the channel header of the incoming digital audio by entering the following command:

```
ARAT 0.0
```

Note: The default frequency is 48 kHz (which is used by DVD players). However, if the external source is an audio CD played on a DVD player, the player will output SPDIF with a sampling rate of 44.1 kHz (not 48 kHz). In this case, set the sampling frequency to 44.1 kHz (or reload the format, which will detect the sampling frequency automatically).

7. Turn on the external audio source. The external audio signal will be encoded into the HDMI signal.

Note: The 882 cannot independently control external source channels. You must use the device generating the audio signal to control the channels.

8. To verify proper HDMI audio handling, check the following on the HDMI display:

- Audio is output from the proper channels (left, right, or both).
- When the volume is adjusted at the external source, the volume is subsequently changed.

9. Select additional audio images (as desired) to verify proper audio handling.

10. To test another HDMI audio output type, return to step 3.

Testing HDMI InfoFrames (882 only)

This section provides steps on how to test handling of auxiliary (InfoFrame) packets by an HDMI display. The 882 loads and sends default Auxiliary Video Information (XAVI), Audio (XAUD), and Source Product Description (XSPD) InfoFrame packet buffers to the display for each format (see table on page 267 for a list of HDMI formats). The XAVI and the XAUD InfoFrame packets are sent at every frame (repeated mode), while the XSPD is sent only once. The XMPG and XGIF InfoFrames are gated off and not enabled.

Note: *This feature is not supported on the 881 generator.*

HDMI provides various types of auxiliary data in the form of InfoFrames. InfoFrames allow the HDMI source to keep an HDMI display informed as to “what is coming down the pipe” so that it can present the content optimally—without any viewer intervention.

There are five different types of InfoFrames:

- auxiliary video information (AVI)
- audio (AUD)
- source product description (SPD)
- MPEG information (MPG)
- generic (vendor-specific) information (GIF)

Each type carries information regarding a different aspect of the HDMI audio/video transmission.

The procedures below can be performed using the front panel or the command line interface.

Viewing InfoFrame contents (882 only)

The 882 provides a convenient method for monitoring the InfoFrame content of the transmitted HDMI signal. The procedure below describes how to view current InfoFrame contents.

Note: *This feature is not supported on the 881 generator.*

To view current HDMI InfoFrame contents transmitted from the 882:

1. Set up the 882 for HDMI output. See “[Setting up the 882 for HDMI testing](#)” on page 271.
2. Press the **Source** key and choose a format suitable for the HDMI display (for example, DMT0660). Refer to the table in “[Format selection](#)” on page 267.

Alternatively, to select the format using the command line interface, enter the following commands:

```
FMTMP /tffs0/Library/Formats // Set format path to 882 memory
```

```

FMTL DMT0660 // Loads the DMT0660 format
FMTU // Activates the DMT0660 format

```

3. Press the **Content** key and choose the PacketTx image.

Alternatively, to select the image using the command line interface, enter the following commands:

```

IMGU /tffs0/Library/Images // Set image path to 882 memory
IMGL PacketTx // Loads the PacketTx image
IMGU // Activates the PacketTX image

```

The PacketTx image appears on the connected HDMI display. The image shows the current settings for the AVI InfoFrame output.

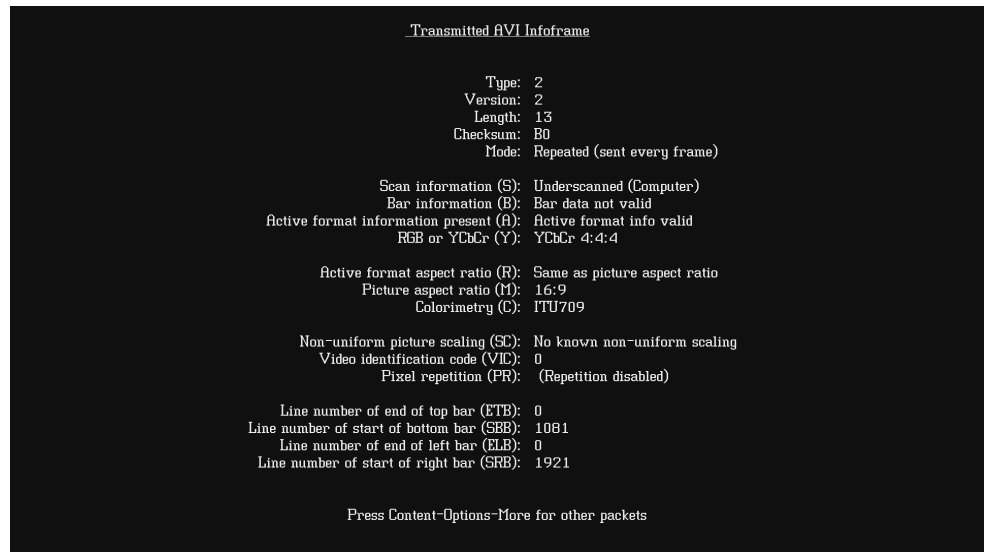

4. Enable and view image versions for the PacketTx image as follows:

a. Press the **Options** key. The following menu appears on the 882's display:

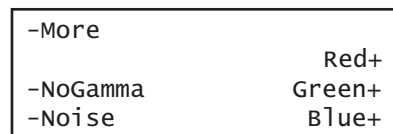

b. Choose the **More** item by pressing the adjacent soft key until a + and Rendition appears next to the item.

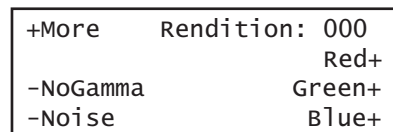

c. Press the + key to advance through the image versions.

Note: The contents of the appropriate InfoFrame output appears on the HDMI display.

Alternatively, to select an image version using the command line interface, enter the following commands:

```
ISUB 1      // Enables sub images
IVER 1      // Specifies the first image version
IMGU       // Activates the image version
```

5. Select additional InfoFrame subimages (as desired) to verify proper InfoFrame handling.
6. When testing is complete, disable image versions by pressing the **Options** key and choosing **More** until a - appears next to it.

Alternatively, to disable image versions using the command line interface, enter the following command:

```
ISUB 0      // Disables sub images
```

To generate a report for the PacketTx image:

1. Press the **Tools** key. The **Tools** menu appears on the 882's display as shown below.

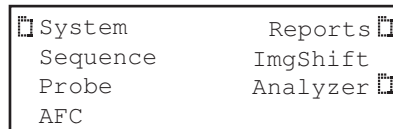

```
System      Reports
Sequence    ImgShift
Probe       Analyzer
AFC
```

2. Choose the **Reports** item by pressing the adjacent soft key. The **Reports** menu appears on the 882's display as shown below.



```
EDID      Packets
```

3. Choose the **Packets** item by pressing the adjacent soft key. The **Packet** menu appears on the 882's display as shown below.

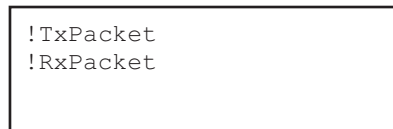

```
!TxPacket
!RxPacket
```

Note: Be sure that you have transferred any existing PacketTx reports to your PC otherwise generating a new report will overwrite the existing report.

4. Select the **!PacketTx** item by pressing the adjacent soft key to generate the report. The following appears on the display.

TX PACKETS
Finished

5. Select a suitable directory on your PC to store the report by navigating in the FTP Browser.
6. Transfer the report from the 882 to your PC, using the FTP browser, by highlighting the report and clicking on the upload activation button.

Make sure to change the names of any existing reports in the directory on your PC to avoid overwriting existing reports.

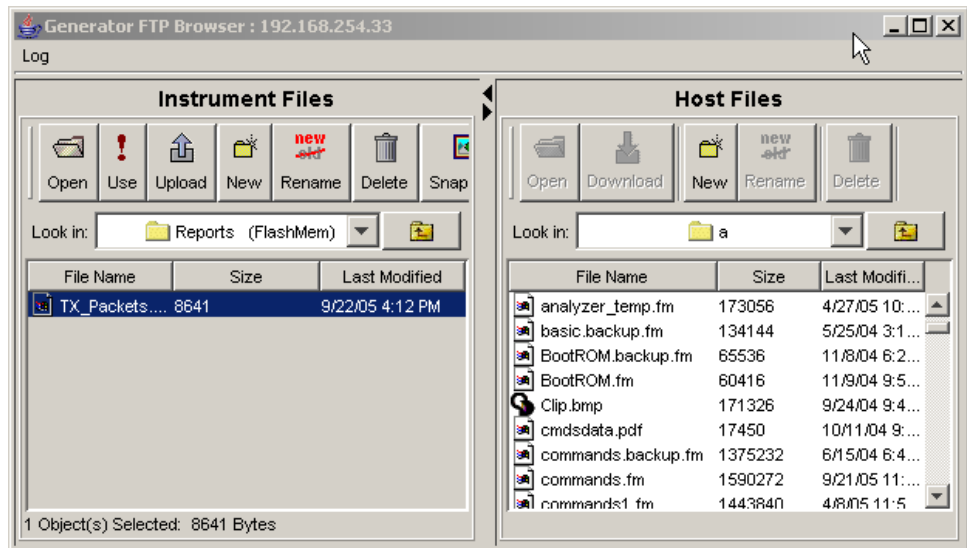

7. Navigate to your PC and double click on the report. A sample of part of the PacketTx report is shown below.

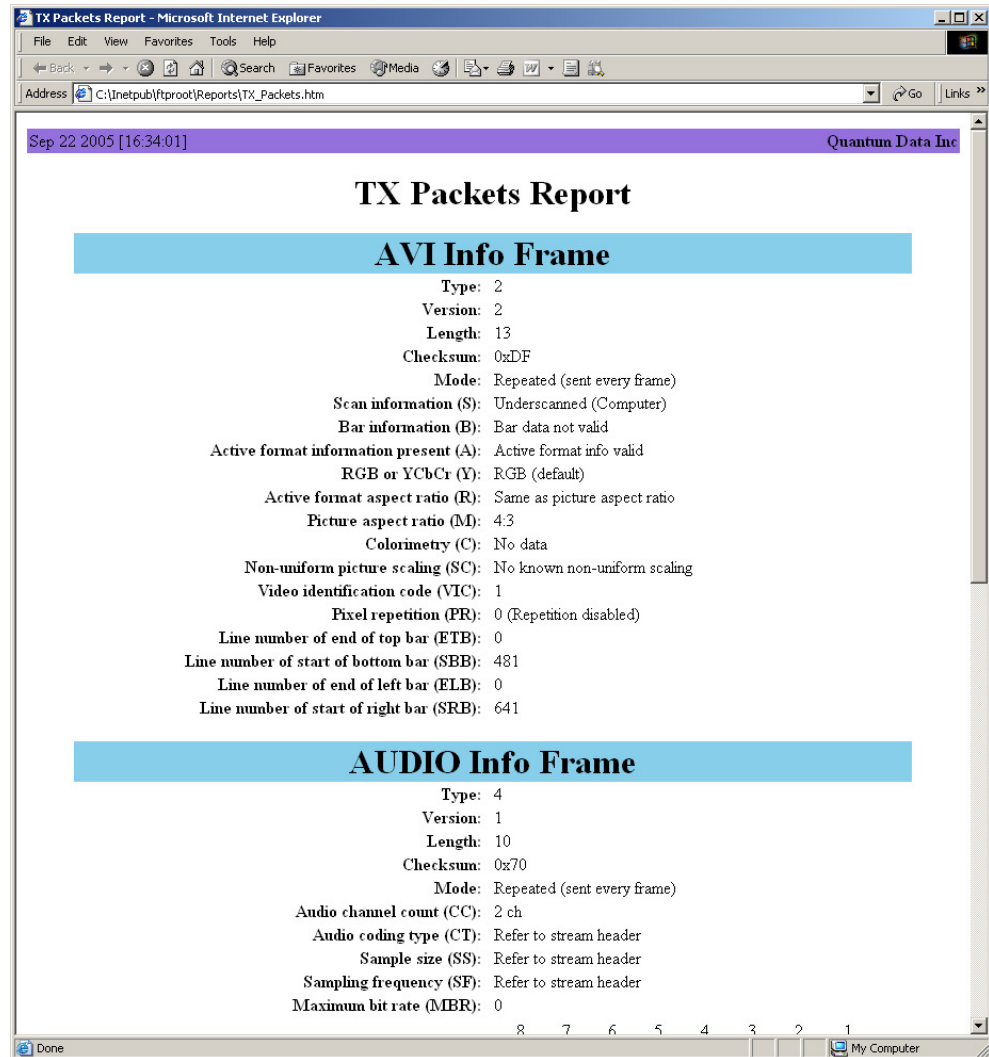

Testing with Active Format Description (AFD) (882 only)

When transporting HDMI video images from a source to a display, different formats may be used between the content, transmission signal, and display. To provide compatibility between the different formats, Active Format Description (AFD) is used.

Note: This feature is not supported on the 881 generator.

AFD describes the portion of the coded video frame that is “of interest” (or “active”). The appropriate AFD information is transmitted with the video to the HDMI display as part of AVI InfoFrame packets. Using AFD information, the display is able to present the image optimally.

For AFD testing, the 882 allows you to apply different AFD cases using the AFDtest image, which provides 12 different cases (as image versions) for both 4:3 and 16:9 displays. As each image version appears, the appropriate AFD information is sent with the video to the display.

The following table lists the AFD cases (as specified in the *ETSI TR 101 154 v.1.4.1* standard) that are provided by the 882.

AFD case	Image Version (4:3 Format)	Image Version (16:9 Format)	Aspect Ratio of Active Area
2	8	7	box 16:9 (top)
3	5	4	box 14:9 (top)
4	9-12	9-12	box > 16:9 (center)
8	0	6	Same as the signal format
9	1	1	4:3 (center)
10	7	8	16:9 (center)
11	4	3	14:9 (center)
13	3	5	4:3 (with shoot and protect 14:9 center)
14	6	2	16:9 (with shoot and protect 14:9 center)
15	2	0	16:9 (with shoot and protect 4:3 center)

To test an HDMI display's ability to support AFD:

1. Set up the 882 for HDMI output. See "[Setting up the 882 for HDMI testing](#)" on page 271.
2. Press the **Source** key and choose a format suitable for the HDMI display (for example, DMT0660).

Alternatively, to select the format using the command line interface, enter the following commands:

```
FMTF /tffs0/Library/Formats // Set format path to 882 memory
FMFL DMT0660 // Loads the DMT0660 format
FMTU // Activates the DMT0660 format
```

3. Press the **Content** key and choose the AFDtest image.

Alternatively, to select the image using the command line interface, enter the following commands:

```
IMGP /tffs0/Library/Images // Set image path to 882 memory
IMGL AFDTEST // Loads the AFDtest image
```

```
IMGU // Activates the AFDtest image
```

The AFDtest image appears on the connected HDMI display.



4. Enable and view image versions for the AFDtest image as follows:
 - a. Press the **Options** key. The following menu appears on the 882's display:

-More	Red+
-NoGamma	Green+
-Noise	Blue+

- b. Choose the **More** item by pressing the adjacent soft key until a + and Rendition appears next to the item.

+More	Rendition: 000
	Red+
-NoGamma	Green+
-Noise	Blue+

- c. Press the + key to advance through the image versions.

Note: Select the image version that corresponds to the AFD case (or code) you want to test. See the table on page 307 for a list of the image numbers that correspond with each AFD case.

Alternatively, to enable and view the image versions using the command line interface, enter the following commands:

```
ISUB 1 // Enables sub images
IVER 1 // Specifies the first image version
IMGU // Activates the image version
```

- Using the selected AFD scenario, verify that the HDMI display presents the image correctly.

Note: *Displays use the AFD information to determine how to present an image. Different displays may present HDMI video with the same AFD differently.*

- Use the + and - keys to adjust the amplitude, frequency, or sampling rate (based on the selected image) of the HDMI audio output. The contents of the appropriate InfoFrame output appears on the HDMI display. For example, the image representing AFD case 11 (image version 4) on a 4:3 display is shown in the example below.

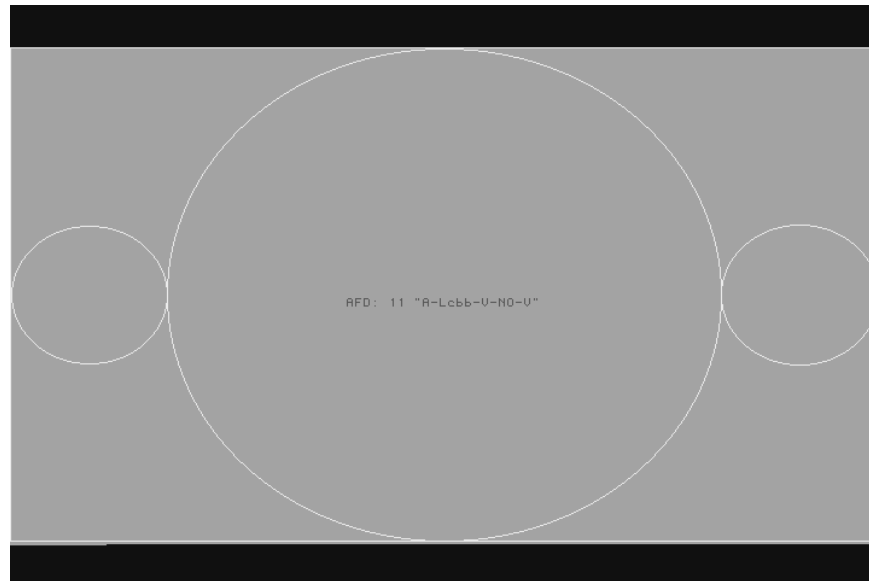

- When testing is complete, disable image versions by pressing the **Options** key and choosing **More** until a - appears next to it.

Alternatively, to disable image versions using the command line interface, enter the following command:

```
ISUB 0 // Disables sub images
```

10 Testing Lipsync

Topics in this chapter:

- [Overview](#)
- [Testing display \(sink\) devices](#)

Overview

This chapter provides procedures for testing the HDMI Auto Lipsync Correction feature. The 882 can be configured to:

- emulate an HDMI source device to test an HDMI sink (display) device
- (optional feature) emulate an HDMI sink (display) device to test an HDMI source device.

With the 882, you can obtain audio and video latency values from the EDID of a connected display, generate a test image with audio/video latency correction applied, and view the image on the display device to determine correct audio/video synchronization.

With the analyzer option, you can test the lipsync correction feature of a HDMI source device. The analyzer can emulate a display device with audio and video latency. Using a test image, the source device applies audio/video latency correction and sends back the test image to the analyzer. Using a built-in application, the analyzer measures for the correct audio/video latency.

Testing display (sink) devices

The 882 can emulate a source device in order to test an HDMI display device's auto lipsync correction handling. With this capability, an HDMI display device can be tested for proper audio and video synchronization using a lipsync test image.

A display's EDID provides audio and video latency fields in the HDMI vendor specific data block of the CEA extension block. Upon reading the EDID, the 882 uses an embedded application to process the audio and video latency values and compensates for the difference within a generated lipsync test image. Using a blinking white box and an audible beep, the lipsync test image allows you to assess proper audio/video synchronization at the display. The illustration below depicts this application.

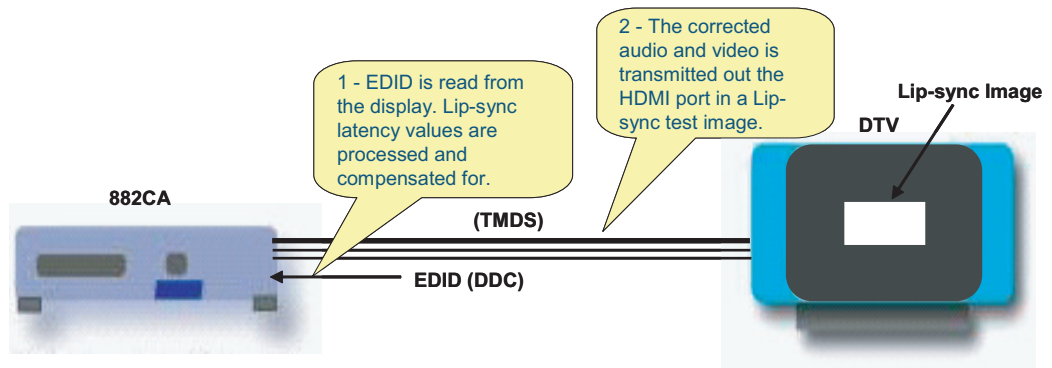

To test display device auto lipsync correction:

1. Establish a session with the 882 using either HyperTerminal over a serial connection or Telnet over an Ethernet LAN. See [“Establishing a terminal session with the 882”](#) on page 30. Connect the 882 HDMI output (Tx) port to the display device.

2. Activate the HDMI-H interface on the output port:

- a. Press the **Interface** key to access the list of interfaces. A listing of signal interfaces appears on the 882's display as shown below.

```
* VGA          CVBS
  HDMI-D      S-VIDEO
  HDMI-H      SDI
```

- b. Choose **HDMI-H** by pressing the adjacent soft key. The interface is activated and the port outputs the currently selected image and format.

```
VGA          CVBS
HDMI-D      S-VIDEO
*HDMI-H     SDI
```

- c. Alternatively, to activate the interface through the command line interface, enter the following commands:

```
XVSI 4          // Selects the HDMI-H interface
ALLU           // Applies the interface setting to the 882
```

3. Read the EDID from the display as follows:

- a. Press the **Sink** key. The following information appears on the 882's display.

```
Manufacturer:SNY
Product Code:144
Serial#:7011007
week:20 Year:1998
```

- b. Press the **Options** key. The following information appears on the 882's display.

```
-EDID Formats    CDF ↵
+HP Bypass
-Emulate
```

- c. Choose the **EDID Formats** item by pressing the adjacent soft key. A + appears next to EDID Formats, indicating it is enabled.

4. Enable lipsync testing in 882 as follows:

a. Press the **Content** key. The following information appears on the 882's display.

Acer1	Acer2
Acer3	Acer4
Acer5	Acer6
Acer7	Acer8

b. Choose either the **LipSyncB** or **LipSync** image.

c. Press the **Settings** key. The following information appears on the 882's display.

	Image	->
	LipSync	->
LSGM	TLAT	PLAT
1	0.0000	0 ->

d. Set the **LSGM** setting to 1 by pressing the soft keys adjacent to the bottom row until the cursor appears on the digit. Press the + or - keys to adjust the setting up or down.

e. Press the **Enter (Options)** key to save the new setting.

Alternatively, to enable the 882 to measure lipsync correction through the command line interface, enter the following command:

```
LSGX:LSGM 1 // Enables lipsync testing
LSGX:LSGU // Activates lipsync testing
```

5. Press the **Content** key. The following information appears on the 882's display.

Acer1	Acer2
Acer3	Acer4
Acer5	Acer6
Acer7	Acer8

6. Choose the image to use for lipsync testing.

- For basic testing, choose the **LipSyncB** test image on display device is similar to shown below.

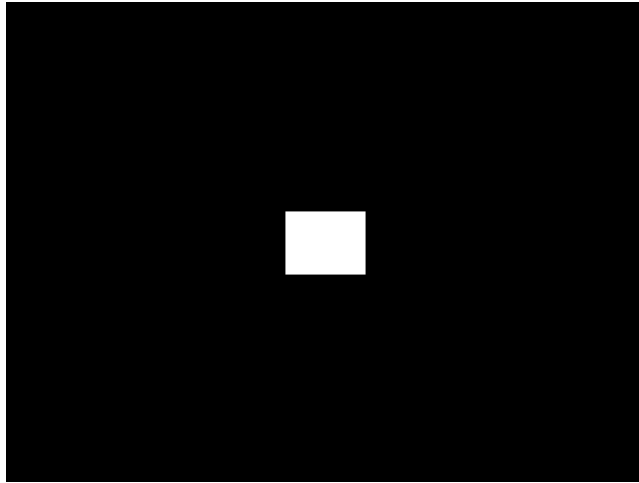

The **LipSyncB** image utilizes a flashing white box with audible click to verify correct audio/video synchronization.

- For more detailed testing, choose the **LipSync** test image on display device is similar to shown below.

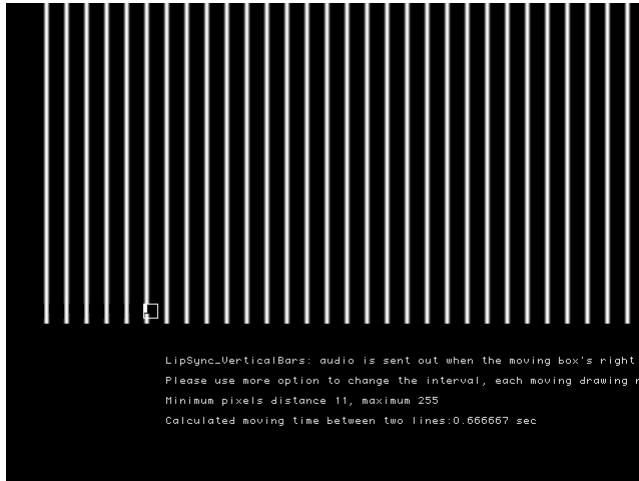

The **LipSync** image utilizes a moving box with audible beep to verify correct audio/video synchronization. When the moving box's right edge touches the middle of a vertical line in the image, an audible beep is sent to the display.

7. (Optional when using **LipSync** image only) To adjust vertical line spacing (thus changing frequency of audible beeps), follow these steps:
- Choose **More** by pressing the adjacent soft key. A **+** and **Rendition** appears next to the item.

+More	Rendition: 000
+LipSync	Red+
-NoGamma	Green+
-Noise	Blue+

- Press **+** and **-** keys to adjust vertical line interval. Changing the interval adjusts calculated moving time for white box between two lines.

Alternatively, to adjust vertical line interval using the command line interface, enter the following commands:

```
ISUB 1 // Enables sub images
IVER 1 // Specifies the first image version
IMGU // Activates the image version
```

- When you are finished, disable image versions by pressing the **Options** key and choosing **More** until a **-** appears next to it.

Alternatively, to disable image versions using the command line interface, enter the following command:

```
ISUB 0 // Disables sub images
```

8. (Optional) To adjust lipsync testing parameters in the generated test image, follow these steps:

a. Press the **Content** key. The following information appears on the 882's display.

Acer1	Acer2
Acer3	Acer4
Acer5	Acer6
Acer7	Acer8

b. Choose the **LipSyncB** or **LipSync** image.

c. Press the **Options** key to access the Options menu.

d. Enable LipSync settings by pressing the adjacent soft key. A + appears next to the **LipSync** item indicating that you can adjust its settings.

+More	Rendition: 000
+LipSync	Red+
-NoGamma	Green+
-Noise	Blue+

e. Press the **Settings** key. The following information appears on the 882's display.

	Image	->
	LipSync	->
LSGM	TLAT	PLAT
1	0.0000	0

f. To select which data stream (audio or video) is generated first, edit the **PLAT** setting (0=video sent first, 1=audio sent first) by pressing the soft keys adjacent to the bottom row until the cursor appears on the digits. Press the + or - keys to adjust the settings up or down.

g. To adjust audio/video latency, edit the **TLAT** setting between 0.0 and 0.5 seconds by pressing the soft keys adjacent to the bottom row until the cursor appears on the digits. Press the + or - keys to adjust the settings up or down.

h. Press the **Enter (Options)** key to save the new setting(s).

Alternatively, to set lipsync testing parameters in the test image through the command line interface, enter the following command:

```
LSGX:TLAT // Sets audio/video latency
LSGX:PLAT // Sets which data stream is generated first
           (0-Video, 1-Audio)
LSGX:LSGU // Updates hardware
```

11 Testing EDID for HDMI

Topics in this chapter:

- [Overview](#)
- [Testing with display \(sink\) devices](#)
- [Testing EDID for HDMI compliance in display \(sink\) devices](#)
- [Using the EDID Compare tool](#)

Overview

This chapter provides procedures for testing EDID generation, emulating and handling. The 882 can be configured to:

- emulate an HDMI, DVI, or VGA source device to test an HDMI, DVI, or VGA sink (display) device.

With the 882, you can both view EDID from a display, and write EDID to a display device (with writable EEPROM). In addition, you can test an HDMI display device's EDID structure and transmission in accordance with the HDMI Compliance Test Specification 1.2.

Additional EDID tests require the analyzer option. These include testing the EDID handling capabilities of a source device, and the HDMI compliance EDID testing for a sink (display) device.

Testing with display (sink) devices

The 882 can emulate a source device in order to test a display device's EDID generation. The EDID data received from a connected display device can be displayed via image or HTML report.

For display devices with writable EEPROM, the 882 can also put (write) a new EDID to the device.

Viewing EDID from a display (882 only)

Follow the procedure to view EDID data received from a DDC-compliant VGA, HDMI, DisplayPort or DVI display connected to the 882. Note that HDMI EDIDs are used in the examples in this procedure.

Note: *This feature is not supported on the 881 generator.*

To view EDID data received from a connected display device:

1. Connect the display under test to the 882.
2. Press the **Source** key and choose a suitable format for the display (for example, DMT0660).

Alternatively, to select the format using the command line interface, enter the following commands:

```
FMTF /tffs0/Library/Formats // Set format path to 882 memory
FMTL DMT0660                // Load the DMT0660 format
FMTU                        // Activate the DMT0660 format
```

3. Read the EDID from the display as follows:

a. Press the **Sink** key. The following information appears on the 882's display.

```

Manufacturer:SNY
Product Code:144
Serial#:7011007
Week:20 Year:1998
    
```

b. Press the **Options** key. The following information appears on the 882's display.

```

-EDID Formats      CDF ⌘
+HP Bypass
-Emulate
    
```

c. Choose the **EDID Formats** item by pressing the adjacent soft key. A + appears next to EDID Formats, indicating it is enabled.

The 882 loads the Source list with formats supported by the connected display (hot-plug formats read via EDID structure of attached display).

Note: To disable hot plug formats, press the soft key adjacent to EDID Formats. A - next to EDID Formats indicates it is disabled.

4. Press the **Content** key. A list of images appears on the 882's display.

5. Choose the **EdidData** image by pressing the adjacent soft key. The image appears on the display as shown below.

Alternatively, to select the image using the command line interface, enter the following commands:

```

IMGL EDIDDATA // Loads the EdidData image
IMGU // Activates the EdidData image
    
```

	0	1	2	3	4	5	6	7	8	9	A	B	C	D	E	F
0	00	FF	FF	FF	FF	FF	FF	00	4D	D9	F8	01	01	01	01	01
10	00	0E	01	03	80	00	00	78	0A	0D	C9	A0	57	47	98	27
20	12	48	4C	20	00	00	01	01	01	01	01	01	01	01	01	01
30	01	01	01	01	01	01	01	1D	80	18	71	1C	16	20	58	2C
40	25	00	10	09	00	00	00	9E	8C	0A	D0	8A	20	E0	2D	10
50	10	3E	96	00	04	03	00	00	00	18	00	00	00	FC	00	53
60	4F	4E	59	20	54	56	0A	20	20	20	20	20	00	00	00	FD
70	00	3B	3D	0F	2E	08	00	0A	20	20	20	20	20	20	01	DF

Block 0

To go to the next step...
Increment the Image Rendition

6. Enable and view image versions for the EdidData image as follows:

a. Press the **Options** key. The following menu appears on the 882's display:

```
-More  
-NoGamma  
-Noise
```

	Red+
	Green+
	Blue+

b. Choose the **More** item by pressing the adjacent soft key until a + and Rendition appears next to the item.

```
+More Rendition: 000  
-NoGamma  
-Noise
```

	Red+
	Green+
	Blue+

c. Press the + and - keys to advance through the image versions.

Alternatively, to enable and view image versions using the command line interface, enter the following commands:

```
ISUB 1 // Enables sub images  
IVER 1 // Specifies the first image version  
IMGU // Activates the image version
```

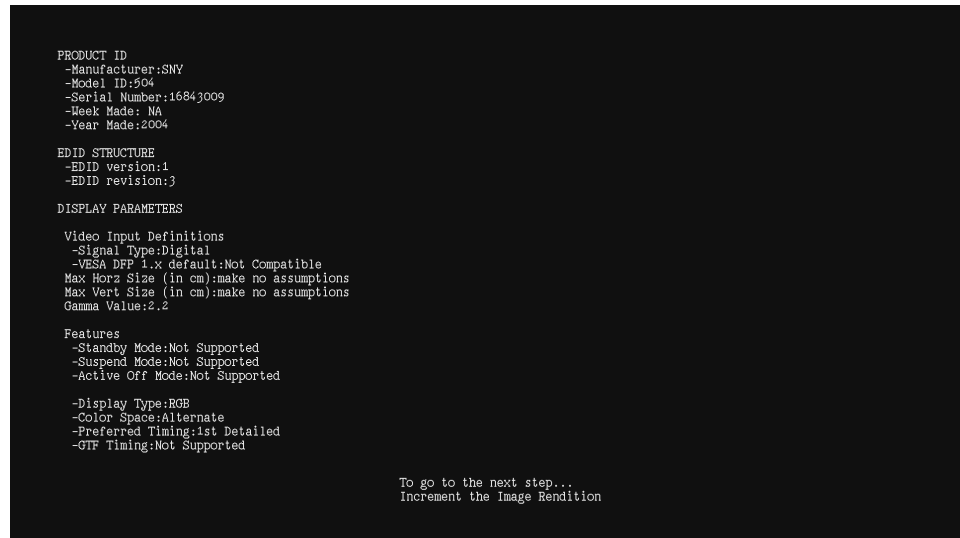

```
PRODUCT ID  
-Manufacturer:SNV  
-Model ID:504  
-Serial Number:16843009  
-Week Made: NA  
-Year Made:2004  
  
EDID STRUCTURE  
-EDID version:1  
-EDID revision:3  
  
DISPLAY PARAMETERS  
  
Video Input Definitions  
-Signal Type:Digital  
-VESA DFP 1.x default:Not Compatible  
Max Horiz Size (in cm):make no assumptions  
Max Vert Size (in cm):make no assumptions  
Gamma Value:2.2  
  
Features  
-Standby Mode:Not Supported  
-Suspend Mode:Not Supported  
-Active Off Mode:Not Supported  
  
-Display Type:RGB  
-Color Space:Alternate  
-Preferred Timing:1st Detailed  
-GTF Timing:Not Supported  
  
To go to the next step...  
Increment the Image Rendition
```

7. When you are finished, disable image versions by pressing the **Options** key and choosing **More** until a - appears next to it.

Alternatively, to disable image versions using the command line interface, enter the following command:

```
ISUB 0 // Disables sub images
```

To view EDID data received from a connected display device using the command line interface:

1. Connect the display under test to the 882.
2. Establish a session with the 882 using either HyperTerminal over a serial connection or Telnet over an Ethernet LAN. See “[Establishing a terminal session with the 882](#)” on page 30 or “[Establishing a Telnet session with the 882](#)” on page 33.
3. Enter one of the following commands:
 - To view the current EDID in ASCII hex format, enter the `EDID?` command..
 - To view a specific segment of EDID, enter the `I2CR? (OUT1:I2CR?, OUT2:I2CR?, VGA:I2CR?)` command (refer to the command description identify the arguments of this query).

Generating an EDID Information Report

Follow the procedure to generate an HTML report of EDID data received from a DDC-compliant VGA, HDMI, DisplayPort or DVI display connected to the 882.

***Note:** HDMI EDIDs are shown in the examples in this procedure.*

To generate a report of EDID data received from a connected display device:

1. Connect the display under test to the 882.
2. Press the **Tools** key. The **Tools** menu appears on the 882’s display as shown below.

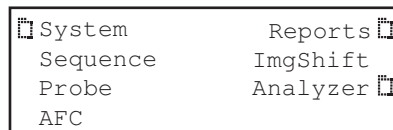

3. Press the **Reports** key. The **Reports** menu appears on the 882’s display as shown below.

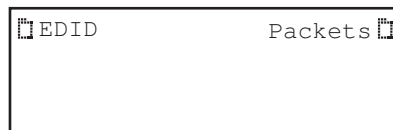

4. Choose the **EDID** item by pressing the adjacent soft key. The **EDID reports** menu appears on the 882’s display as shown below.

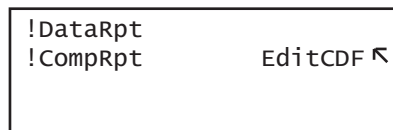

Note: Be sure that you have transferred any existing EDID reports to your PC. Otherwise, generating a new report overwrites the existing report.

5. Choose **!DataRpt** item by pressing the adjacent soft key. An EDID Information Report is generated and stored on the PCMCIA card in the **/card0/Library/Reports/Edid_Data.htm** file.
6. Open the FTP Browser on the 882 and select a suitable directory on your PC to store the report.
7. Using the FTP Browser, transfer the report from the 882 PCMCIA card to your PC like shown below.

Note: Make sure to change the names of any existing reports in the directory on your PC to avoid overwriting existing reports.

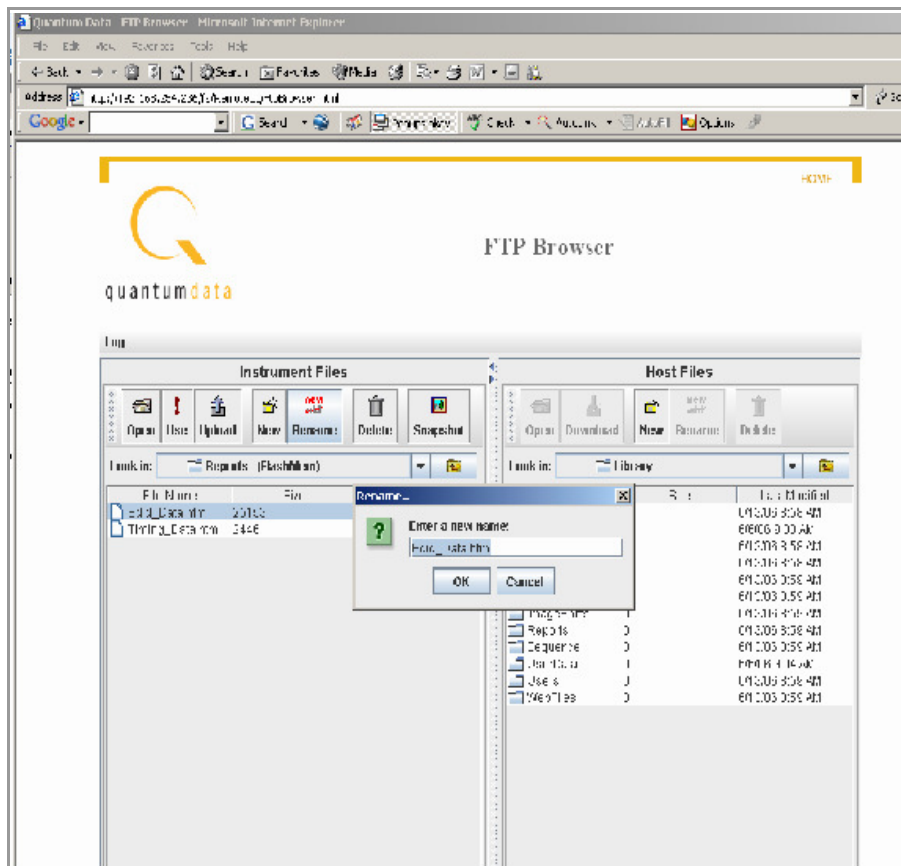

8. Navigate to your PC and double click on the report. A sample is shown below.

Apr 27 2005 [16:20:51] Quantum Data Inc

EDID Information Report

	0	1	2	3	4	5	6	7	8	9	A	B	C	D	E	F
00:	00	FF	FF	FF	FF	FF	FF	00	44	89	B2	00	05	00	00	00
10:	0D	0C	01	03	80	50	2D	78	0A	0D	C9	A0	57	47	98	27
20:	12	48	4C	20	00	00	01	01	01	01	01	01	01	01	01	01
30:	01	01	01	01	01	01	01	1D	80	18	71	1C	16	20	58	2C
40:	25	00	C4	8E	21	00	00	9E	8C	0A	D0	8A	20	E0	2D	10
50:	10	3E	96	00	13	8E	21	00	00	18	00	00	00	FC	00	48
60:	44	4D	49	20	54	56	0A	20	20	20	20	20	20	00	00	FD
70:	00	3B	3D	0F	2E	08	00	0A	20	20	20	20	20	20	01	08

Block 0

	0	1	2	3	4	5	6	7	8	9	A	B	C	D	E	F
00:	02	03	1C	F1	49	85	04	08	02	01	06	14	12	16	23	09
10:	07	07	83	01	00	00	65	03	0C	00	10	00	01	1D	00	72
20:	51	D0	1E	20	6E	28	55	00	C4	8E	21	00	00	1E	D6	09
30:	80	A0	20	E0	2D	10	10	60	22	00	12	8E	21	08	08	18
40:	8C	0A	D0	90	20	40	31	20	0C	40	55	00	C4	8E	21	00
50:	00	18	01	1D	80	D0	72	1C	16	20	10	2C	25	80	C4	8E
60:	21	00	00	9E	8C	0A	A0	14	51	F0	16	00	26	7C	43	00
70:	13	8E	21	00	00	98	00	00	00	00	00	00	00	00	00	94

Block 1

PRODUCT ID

- Manufacturer:QDI
- Model ID:178
- Serial Number:5
- Week Made: 13
- Year Made:2002

Modifying EDID in a display

If the EEPROM in the display is writable, you can write a new EDID to the device. Follow the procedure to overwrite the EDID structure stored in the connected display device with a new EDID structure.

Important: Be sure to save a backup copy of the EDID stored on the display device. Writing an EDID using this procedure will overwrite the EDID currently stored on the display device.

To write an EDID to the display device:

1. Establish a session with the 882 using either HyperTerminal over a serial connection or Telnet over an Ethernet LAN. See “[Establishing a terminal session with the 882](#)” on page 30 or “[Establishing a Telnet session with the 882](#)” on page 33.
2. Connect the display under test to the 882.
3. Load an EDID from the 882 using the following command:

```
DIDL filename
```

4. Write the EDID to connected display device using the following command:

```
EDA<n>:PDID
```

Where <n> is the output port. For example, the command below writes the EDID out the Out 2 port.

```
EDA2:PDID
```

Capturing and storing EDID from display device

Follow the procedure to capture and store an EDID structure from a display device connected to the 882's HDMI output (Tx) port.

To capture and store an EDID from a connected HDMI/DVI display device:

1. Establish a session with the 882 using either HyperTerminal over a serial connection or Telnet over an Ethernet LAN. See "[Establishing a terminal session with the 882](#)" on page 30 or "[Establishing a Telnet session with the 882](#)" on page 33.
2. Connect the 882 HDMI output (Tx) port to the display device whose EDID you wish to capture.
3. Activate the HDMI-H or HDMI-D interface on the output port:
 - a. Press the **Interface** key to access the list of interfaces. A listing of signal interfaces appears on the 882's display as shown below.

* VGA	CVBS
HDMI-D	S-VIDEO
HDMI-H	SDI

- b. Choose the HDMI-H or HDMI-D item by pressing the adjacent soft key. The interface is activated and the port outputs the currently selected image and format.

VGA	CVBS
HDMI-D	S-VIDEO
*HDMI-H	SDI

- c. Alternatively, to activate the interface through the command line interface, enter the following commands:

```
XVSI 3 (or 4) // Selects the HDMI-D (or HDMI-H) interface  
ALLU // Applies the interface setting to the 882
```

4. Capture the EDID from the connected display device by entering the following command:

```
EDA<port>:GDID
```

Where *port* is the HDMI output port (1 or 2) that the display is connected to. For example, the command below loads an EDID from a display device connected to the 882's HDMI Out port 1.

```
EDA1:GDID
```

5. Store the captured EDID in the 882's internal file system by entering the following command:

```
DIDA filename
```

Where *filename* is the name of a file in the default directory identified by **DIDP**. For example, the command below store an EDID to the default EDID path.

```
DIDA myedid1
```

If you want to store the EDID file in a location that is not the default path, you can either list the path explicitly on the **DIDA** command line or change the EDID path with **DIDP**. For example, the command below loads an EDID from a different directory in flashmem.

```
DIDA /tffs0/library/userdata/myedid1
```

6. (Optional) Use the captured EDID to emulate the display device on the analyzer by entering the following command:

```
EDE<port>:DIDU
```

Where *port* is the HDMI input (Rx) port (1 or 2) that you want to configure to emulate the EDID. For example, the command below loads the EDID stored in the EDID edit buffer for emulation into the HDMI input (Rx) port 2.

```
EDE2:DIDU
```

Creating or editing EDID contents

You can create or modify an EDID structure to emulate a specific display device using one of the following methods:

- Using the EDID Editor tool. See “[Using the EDID Editor tool](#)” on page 352 for details on using the EDID Editor tool
- Loading EDID into memory buffer and creating/modifying content using EDID editing commands. See following procedure for details.

To create/edit an EDID using EDID editing commands:

1. Establish a session with the 882 using either HyperTerminal over a serial connection or Telnet over an Ethernet LAN. See “[Establishing a terminal session with the 882](#)” on page 30 or “[Establishing a Telnet session with the 882](#)” on page 33.

2. To create a new EDID, follow these steps:

a. Create a new EDID file by entering the following command:

```
DIDN filename
```

b. Define EDID structure content using EDID edit commands. The following example shows how you can create EDID content:

```
DIDB // begins an edid editing session
XDID 0 80
00FFFFFFFFFFFF005A63118F01010101130D010380221B782A4706A55C47
9C251E4F54BFEF008180310A01010101010101010101010101302A009851002A4030
701300520E1100001E000000FF004132333033313931353335390A000000FD0032
4B1E530E000A2020202020000000FC0056583730302D330A20202020200095
DIDE // ends an edid editing session
```

Note: The EDID edit buffer commands are new with Release 2.3.0.

c. Save EDID file to the 882 by entering the following command:

```
DIDS // saves the edid
```

3. To modify an existing EDID (stored on the 882), follow these steps:

a. Load an EDID from the 882's internal file system:

```
DIDL filename
```

Where *filename* is the name of a file in the default directory identified by **DIDP**. For example, the command below loads an EDID from the default EDID path.

```
DIDL myedid1
```

If the EDID you want to load is not in the default path, you can either list the path explicitly on the **DIDL** command line or change the EDID path with **DIDP**. For example, the command below loads an EDID from a different directory in flash memory.

```
DIDL /tffs0/library/userdata/myedid1
```

b. Modify EDID structure content using EDID edit commands. The following example shows how you can modify EDID content:

```
DIDB // begins an edid editing session
XDID 19 A E88A82A0564796240F48 // edits EDID at 19 for 10 (0x0A) bytes
DIDE // ends an edid editing session
```

Note: The EDID edit buffer commands are new with Release 2.3.0.

c. Save edits to EDID file to the 882 by entering the following command:

```
DIDS // saves the edid
```

Testing EDID for HDMI compliance in display (sink) devices

The 882 supports the following EDID and video HDMI compliance tests in accordance with the HDMI Compliance Test Specification 1.4 (CTS):

- Test ID 8-1: EDID Readable
- Test ID 8-2: EDID VESA Structure
- Test ID 8-3: CEA Timing Extension Structure
- Test ID 8-17: 861B Format Support Requirements
- Test ID 8-18: HDMI Format Support Requirements
- Test ID 8-19: Pixel Encoding Requirements
- Test ID 8-20: Video Format Timing

These tests are intended for in-house testing of products before submission to an HDMI ATC for full certification testing.

Note: *This feature is not supported on the 881 generator.*

Testing HDMI sink device for EDID compliance

HDMI sink compliance testing is conducted through the 882's HDMI OUT connector. A standard HDMI-to-HDMI cable connects the device under test to the 882. The 882 must be configured to output HDMI signals.

You can run the EDID compliance test on an HDMI sink device in three ways: 1) through the front panel using the EDIDHDMI image, 2) using the EDID Compliance report also available through the front panel or 3) using the Compliance Controller. The Compliance Controller is an application (available in release 2.18 or later) that is available on the 882 web home page. This section includes procedures for running the EDID compliance test in all of the three ways.

Defining the capabilities of the display device under test

After making the physical connections, you must specify the capabilities of the sink display under test, which are based on the Capabilities Declaration Form (Appendix 3) of the Compliance Test Specification. This enables the 882 to compare the expected results with the actual results measured from the display.

The manner in which you define the CDF depends on which method you are using to run the test (front panel or Compliance Controller). The following table provides a description of the parameters in the EDID CDF that need to be defined. Use this table as a reference when entering the CDF for any test regardless of the test method (i.e. front panel or Compliance Controller). One key advantage of using the Compliance Controller to run the

test and set the CDF is that it enables you to automatically generate a baseline CDF from the sink devices EDID. The following table describes the EDID CDF parameters and their settings.

Parameter	Explanation
HDMI Output Count	The number of outputs the sink under test has. It is a value in the range of 0-9.
HDMI Input Port	The CEC input on the sink under test. It is a value in the range of 1-15.
CEC Root Device	Indicates if the CEC device is a root device (i.e. a TV without a repeater). The values are + for yes and - for no.
Primary AR: 4:3	Indicates the primary aspect ratio of the sink device under test. This can be either 4:3, 16:9 or both. The values are + for yes and - for no.
HDTV	Indicates if the sink under test supports HDTV. The values are + for yes and - for no. The values are + for yes and - for no.
YUV on Other	Indicates if the sink under test supports YUV. The values are + for yes and - for no. The values are + for yes and - for no.
60Hz	Indicates whether the device supports formats with 60Hz frame rate. The values are + for yes and - for no.
50Hz	Indicates whether the sink under test supports formats with 50Hz frame rate. The values are + for yes and - for no.
640x480p/60	Indicates whether the sink supports the DMT0660 format. The values are + for yes and - for no.
720x480p/60 4:3	Indicates whether the sink supports the 480p60 format with a 4:3 aspect ratio. The values are + for yes and - for no.
720x480p/60 16:9	Indicates whether the sink supports the 480p60SH format with a 16:9 aspect ratio. The values are + for yes and - for no.
1280x720p/60 16:9	Indicates whether the sink under test supports the 720p60 format. The values are + for yes and - for no.
1920x1080i/60 16:9	Indicates whether the sink under test supports the 1080i60 format. The values are + for yes and - for no.
1440x480i/60 4:3	Indicates whether the sink under test supports the 480i2x60 format with double clocking at 4:3 aspect ratio. The values are + for yes and - for no.
1440x480i/60 16:9	Indicates whether the sink under test supports the 480i2x60 format with double clocking at 16:9 aspect ratio. The values are + for yes and - for no.

Parameter	Explanation
720x576p/50 4:3	Indicates whether the sink supports the 576p50 format with a 4:3 aspect ratio. The values are + for yes and - for no.
720x576p/50 16:9	Indicates whether the sink supports the 576p50 format with a 16:9 aspect ratio. The values are + for yes and - for no.
1280x720p/50 16:9	Indicates whether the sink under test supports the 720p50 format. The values are + for yes and - for no.
1920x1080i/50 16:9	Indicates whether the sink under test supports the 1080i50 format. The values are + for yes and - for no.
1440x576i/50 4:3	Indicates whether the sink under test supports the 576i2x50 format with double clocking at 4:3 aspect ratio. The values are + for yes and - for no.
1440x576i/50 16:9	Indicates whether the sink under test supports the 576i2x50 format with double clocking at 16:9 aspect ratio. The values are + for yes and - for no.
1440x480i/50 4:3	Indicates whether the sink under test supports the 480i2x50 format with double clocking at 4:3 aspect ratio. The values are + for yes and - for no.
1440x480i/50 16:9	Indicates whether the sink under test supports the 480i2x50 format with double clocking at 16:9 aspect ratio. The values are + for yes and - for no.
720p/60 On Other	Indicates whether the sink under test supports the analog component video input for 720p60. The values are + for yes and - for no.
1080i/60 On Other	Indicates whether the sink under test supports the analog component video input for 1080i60. The values are + for yes and - for no.
480p/60 On Other	Indicates whether the sink under test supports the analog component video input for 480p60. The values are + for yes and - for no.
720p/50 On Other	Indicates whether the sink under test supports the analog component video input for 720p50. The values are + for yes and - for no.
1080i/50 On Other	Indicates whether the sink under test supports the analog component video input for 1080i50. The values are + for yes and - for no.
576p/50 On Other	Indicates whether the sink under test supports the analog component video input for 576p50. The values are + for yes and - for no.
Supports AI	Indicates whether the sink under test supports audio information. The values are + for yes and - for no.
HDMI 1.4 Testing	Does the sink support HDMI 1.4 features. The values are + for yes and - for no.

Parameter	Explanation
3D	Does the sink support 3D formats. The values are + for yes and - for no.
3D Additional	Does the sink support 3D additional formats in addition to the mandatory 3D formats. The values are + for yes and - for no.
4K x 2K	Does the sink support 4K x 2K formats. The values are + for yes and - for no.
Basic Audio	Indicates whether the sink supports basic audio. The values are + for yes and - for no.
Connector Type A	Indicates whether the sink under test input connector is a Type A connector.
Write Protected	Indicates whether the EDID of the sink under test is write protected.
HDMI 1.3B CTS	Indicates whether to test sink against HDMI Compliance Test Specification (CTS) 1.3b or 1.2a. The values are + for 1.3b or - for 1.2a.
Deep Color	Indicates whether the sink under test supports deep color. The values are + for yes and - for no.
DC 30 Bit	Indicates whether the sink under test supports deep color at 30 bits per pixel. The values are + for yes and - for no.
DC 36 Bit	Indicates whether the sink under test supports deep color at 36 bits per pixel. The values are + for yes and - for no.
DC 48 Bit	Indicates whether the sink under test supports deep color at 48 bits per pixel. The values are + for yes and - for no.
DC YCbCr 4:4:4	Indicates whether the sink under test supports deep color in YCbCr 4:4:4. The values are + for yes and - for no.
xvYCC	Indicates whether the sink under test supports xvYCC601 or xvYCC709. The values are + for yes and - for no.
Exceeds 165MHz	Indicates whether the sink under test supports any video format/color mode with a TMDS clock frequency above 165MHz. The values are + for yes and - for no.
1920x1080p/60 16:9	Indicates whether the sink under test supports the 1080p60 format at 16:9 aspect ratio. The values are + for yes and - for no.
1920x1080p/50 16:9	Indicates whether the sink under test supports the 1080p50 format at 16:9 aspect ratio. The values are + for yes and - for no.

Parameter	Explanation
Dual-Link DVI	Indicates whether the sink under test supports dual-link DVI. The values are + for yes and - for no.
Lipsync Indicated	Indicates whether the EDID of the sink under test indicates lipsync latency values. The values are + for yes and - for no.
Dual Latencies	Indicates whether the sink under test's audio and video latency is substantially different when handling interlaced video formats versus when handling progressive video formats. The values are + for yes and - for no.

Setting up 882 for HDMI sink device EDID compliance testing

Follow these procedures to set up the 882 for HDMI sink testing for EDID compliance. You will use this procedure regardless of whether you are running the EDID compliance test through the front panel or the Compliance Controller.

To set up the 882 for HDMI sink EDID compliance testing:

1. Connect an HDMI-to-HDMI cable between the HDMI OUT connector on the 882 and the HDMI connector on the display under test.
2. Press the **Source** key and choose a valid HDMI format (for example, DMT0660) by pressing the adjacent soft key.

Alternatively, to select the format through the command line interface, enter the following command:

```
FMTL DMT0660
FMTU
```

3. Activate the HDMI-H interface on the output port as follows:

Note: You may have to select a valid HDMI format at this point.

- a. Press the **Interface** key. A listing of signal interfaces appears on the 882's display as shown below.

```
* VGA                CVBS
HDMI-D              S-VIDEO
HDMI-H              SDI
```

- b. Choose the **HDMI-H** item by pressing the adjacent soft key. The interface is activated and the port outputs the currently selected image and format.

```
VGA                CVBS
HDMI-D              S-VIDEO
*HDMI-H            SDI
```

- c. Alternatively, to activate the interface through the command line interface, enter the following commands:

```
XVSI 4           // Selects the HDMI-H interface
ALLU             // Applies the interface setting to the 882
```

4. Press the **Sink** key, and then press the **Options** key. The following menu appears on the 882's display:

```
-EDID Formats      CDF ↵
+HP Bypass
-Emulate
```

5. Choose the **CDF** item by pressing the adjacent soft key. The CDF parameters appear on the 882's display as shown below.

```
0:HDMI Output Count
1:HDMI Input Port
-CEC Root Device
>Primary AR: 4:3
```

6. Set characteristics of the display under test using CDF parameters. Scroll through the list by pressing the + key.

Refer to “[Defining the capabilities of the display device under test](#)” on page 330 for definitions for each parameter in the CDF.

Note: If you are running the EDID compliance test through the Compliance Controller, you do not need to configure the CDF through the front panel.

Running the EDID compliance test through the front panel

Use the following procedure to run the EDID compliance test through the front panel. You can run the EDID compliance test through the front panel either by using the EDIDHDMI image or the EDID compliance report. Refer to “[Running the HDMI EDID Compliance test report](#)” on page 342 for instructions on running the EDID compliance test through the compliance report feature.

To perform HDMI sink EDID compliance testing using the EDID HDMI image:

1. Set up 882 for HDMI sink testing for EDID compliance. See “[Setting up 882 for HDMI sink device EDID compliance testing](#)” on page 334 on for details.
2. Press the **Content** key and choose the **EdidHDMI** image for testing displays connected to HDMI output 1 (use **EDIDHDM2** image for HDMI output 2) by pressing the adjacent soft key.

Alternatively, to select the image through the command line interface, enter the following command:

```
IMGL EdidHDMI
IMGU
```

3. Enable image versions for the EdidHDMI/EdidHDM2 image as follows:

- a. Press the **Options** key. The following menu appears on the 882's display:

-More	Red+
-NoGamma	Green+
-Noise	Blue+

- b. Choose the **More** item by pressing the adjacent soft key until a + and Rendition appears next to the item.

+More	Rendition: 000
	Red+
-NoGamma	Green+
-Noise	Blue+

Alternatively, to enable and view image versions using the command line interface, enter the following commands:

```
ISUB 1 // Enables sub images
IVER 1 // Specifies the first image version
IMGU // Activates the image version
```

4. Press the + key to advance through the image versions and view results for tests 8-1, 8-2, 8-3, 8-17, 8-18, and 8-19. Test descriptions and sample screens are provided below.

- **Testing EDID readability (Test ID 8-1)**—this test verifies that the EDID can be read properly.

	0	1	2	3	4	5	6	7	8	9	A	B	C	D	E	F
0	00	FF	FF	FF	FF	FF	FF	00	4D	D9	F8	01	01	01	01	01
10	00	0E	01	03	80	00	00	78	0A	0D	C9	A0	57	47	98	27
20	12	48	4C	20	00	00	01	01	01	01	01	01	01	01	01	01
30	01	01	01	01	01	01	01	1D	80	18	71	1C	16	20	58	2C
40	25	00	10	09	00	00	00	9E	8C	0A	D0	8A	20	E0	2D	10
50	10	3E	96	00	04	03	00	00	00	18	00	00	00	FC	00	53
60	4F	4E	59	20	54	56	0A	20	20	20	20	20	00	00	00	FD
70	00	3B	3D	0F	2E	08	00	0A	20	20	20	20	20	20	01	DF

```

Test ID 8-1: EDID Readable
PASS--Block 0 header
PASS--Block 0 checksum
PASS--Number of extension blocks is 1
Block 0
To go to the next step...
Increment the Image Rendition

```

	0	1	2	3	4	5	6	7	8	9	A	B	C	D	E	F
0	02	03	1A	76	47	85	02	03	04	06	07	01	23	09	07	07
10	83	01	00	00	65	03	0C	00	10	00	01	1D	00	72	51	D0
20	1E	20	6E	28	55	00	10	09	00	00	00	1E	8C	0A	A0	14
30	51	F0	16	00	26	7C	43	00	04	03	00	00	00	98	8C	0A
40	D0	8A	20	E0	2D	10	10	3E	96	00	10	09	00	00	00	18
50	8C	0A	A0	14	51	F0	16	00	26	7C	43	00	10	09	00	00
60	00	98	00	00	00	00	00	00	00	00	00	00	00	00	00	00
70	00	00	00	00	00	00	00	00	00	00	00	00	00	00	00	97

```

(Continue...) Test ID 8-1: EDID Readable
PASS--Block 1 checksum
Block 1
To go to the next step...
Increment the Image Rendition

```

- **Testing EDID VESA structure (Test ID 8-2)**—this test verifies that the data in the base EDID 1.3 block and basic EDID Extension handling is correct and meets all aspects of the relevant specifications.

```
Test_ID_8-2:EDID_VESA_Structure
PASS->Correct EDID version
PASS->Correct Video Information Byte
PASS->Correct Preferred Timing Bit
PASS->Preferred Timing descriptor
PASS->Monitor Range Limits header
PASS->Monitor Name header
PASS->Monitor Descriptor follows DTD

To go to the next step...
Increment the Image Rendition
```

- **Testing CEA timing extension structure (Test ID 8-3)**—this test verifies that the data in any CEA Timing Extension present in EDID is formatted properly and meets all aspects of the relevant specifications.

```
Test_ID 8-3:CEA Timing Extension Structure

PASS->CEA T.E. in EDID block 1
PASS->Correct CEA T.E. version in EDID block 1
PASS->Legal Data Block types in EDID block 1
PASS->Basic Audio and Audio Data Block are found in EDID block 1
PASS->Audio Block length is a multiple of 3 in EDID block 1
PASS->Short Audio Descr. Rsvd bits are zeros in EDID block 1
PASS->Short Audio Descr. Rsvd byte is zero in EDID block 1
PASS->One Speaker Alloc. Data Block is present in EDID block 1
PASS->Legal Speaker Alloc Block length in EDID block 1
PASS->Speaker Alloc Descr. Rsvd bits zero in EDID block 1
PASS->Speaker Alloc rsvd bytes zeros in EDID block 1
PASS->d points to correct location in EDID block 1
PASS->Zero value in padding DTD in EDID block 1

To go to the next step...
Increment the Image Rendition
```

```
(continue...) Test_ID 8-3: CEA Timing Extension Structure

PASS->HDMI VSDB is present in EDID block 1
PASS->Physical address in HDMI VSDB is 1.0.0.0
FAIL->Incorrect Support AI field 1
PASS->Only one HDMI VSDB is present in EDID block 1
PASS->Correct number of preferred timing in EDID block 1

To go to the next step...
Increment the Image Rendition
```

- **Testing 861C format support requirements (Test ID 8-17)**—this test verifies that no 861D-defined video format is declared only in a Detailed Timing Descriptor.

```
Test_ID 8-17: 861C Format Support Requirements

DETAILED TIMING # 1:
PASS->DTD matches an 861C format with VIC = 5
PASS->SVD that matches the VIC of the 861C format is found
PASS->Pixel clock of DTD exactly matches that of the 861 format

DETAILED TIMING # 2:
PASS->DTD matches an 861C format with VIC = 2
PASS->SVD that matches the VIC of the 861C format is found
PASS->Pixel clock of DTD exactly matches that of the 861 format

To go to the next step...
Increment the Image Rendition
```

```
(Continue...) Test_ID 8-17: 861C Format Support Requirements

DETAILED TIMING # 3:
PASS->DTD matches an 861C format with VIC = 4
PASS->SVD that matches the VIC of the 861C format is found
PASS->Pixel clock of DTD exactly matches that of the 861 format

DETAILED TIMING # 4:
PASS->DTD matches an 861C format with VIC = 6
PASS->SVD that matches the VIC of the 861C format is found
PASS->Pixel clock of DTD exactly matches that of the 861 format

DETAILED TIMING # 5:
PASS->DTD matches an 861C format with VIC = 3
PASS->SVD that matches the VIC of the 861C format is found
PASS->Pixel clock of DTD exactly matches that of the 861 format

DETAILED TIMING # 6:
PASS->DTD matches an 861C format with VIC = 7
PASS->SVD that matches the VIC of the 861C format is found
PASS->Pixel clock of DTD exactly matches that of the 861 format

To go to the next step...
Increment the Image Rendition
```

```
(Continue...) Test ID 8-17: 864C Format Support Requirements
FAIL->CDF field Sink_primaryAR = 4:3

To go to the next step...
Increment the Image Rendition
```

- **Testing HDMI format support requirements (Test ID 8-18)**—this test verifies that the display under test indicates support for all required video formats in its EDID.

```
Test ID 8-18: HDMI Format Support Requirements
PASS->CDF field Sink_60Hz
PASS->CDF fields Sink_60Hz and Sink_HDTV
FAIL->CDF field Sink_50Hz
FAIL->CDF fields Sink_50Hz and Sink_HDTV
PASS->CDF field Sink_720p60
PASS->CDF field Sink_1080i60
FAIL->CDF field Sink_720p50
FAIL->CDF field Sink_1080i50

To go to the next step...
Increment the Image Rendition
```

- **Testing Pixel Encoding Requirements (Test ID 8-19)**—verifies that the display under test supports YCbCr pixel encoding when required.

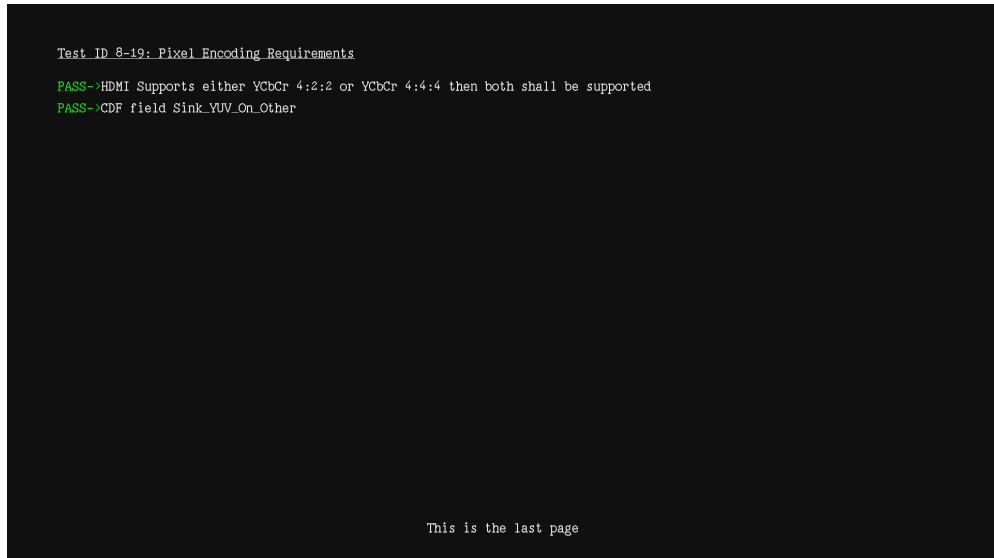

Running the HDMI EDID Compliance test report

Follow the procedure to generate an HTML report of EDID compliance test results. Prior to running this test you will need to configure the 882 for the test. Refer to “[Setting up 882 for HDMI sink device EDID compliance testing](#)” on page 334 for instructions on setting up the 882 for the EDID test.

To generate a report of EDID compliance test results:

1. Press the **Tools** key. The **Tools** menu appears on the 882’s display as shown below.

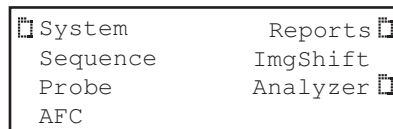

2. Press the **Reports** key. The **Reports** menu appears on the 882’s display as shown below.



3. Choose the **EDID** item by pressing the adjacent soft key. The **EDID reports** menu appears on the 882's display as shown below.



Note: Be sure that you have transferred any existing EDID reports to your PC. Otherwise, generating a new report overwrites the existing report.

4. Define the capabilities declaration form for the sink device you are going to test by selecting the **EditCDF** item. Select the adjacent soft key.

Refer to “[Defining the capabilities of the display device under test](#)” on page 330 for instructions on defining the CDF.
5. Choose **!CompRpt** item by pressing the adjacent soft key. An HDMI EDID Compliance Report is generated and stored on the PCMCIA card in the **/card0/Library/Reports/Edid_Compliance.htm** file.
6. Open the FTP Browser on the 882 and select a suitable directory on your PC to store the report.
7. Using the FTP Browser, transfer the report from the 882 PCMCIA card to your PC like shown below.

Note: Make sure to change the names of any existing reports in the directory on your PC to avoid overwriting existing reports.

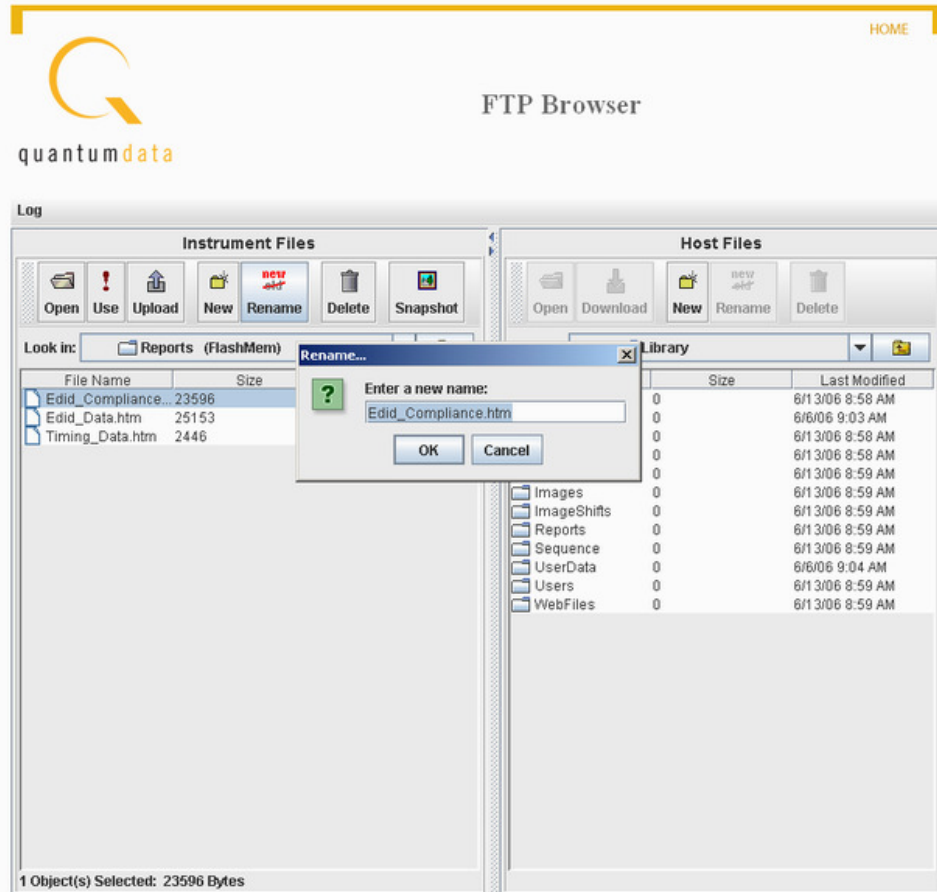

8. Navigate to your PC and double click on the report. A sample is shown below.

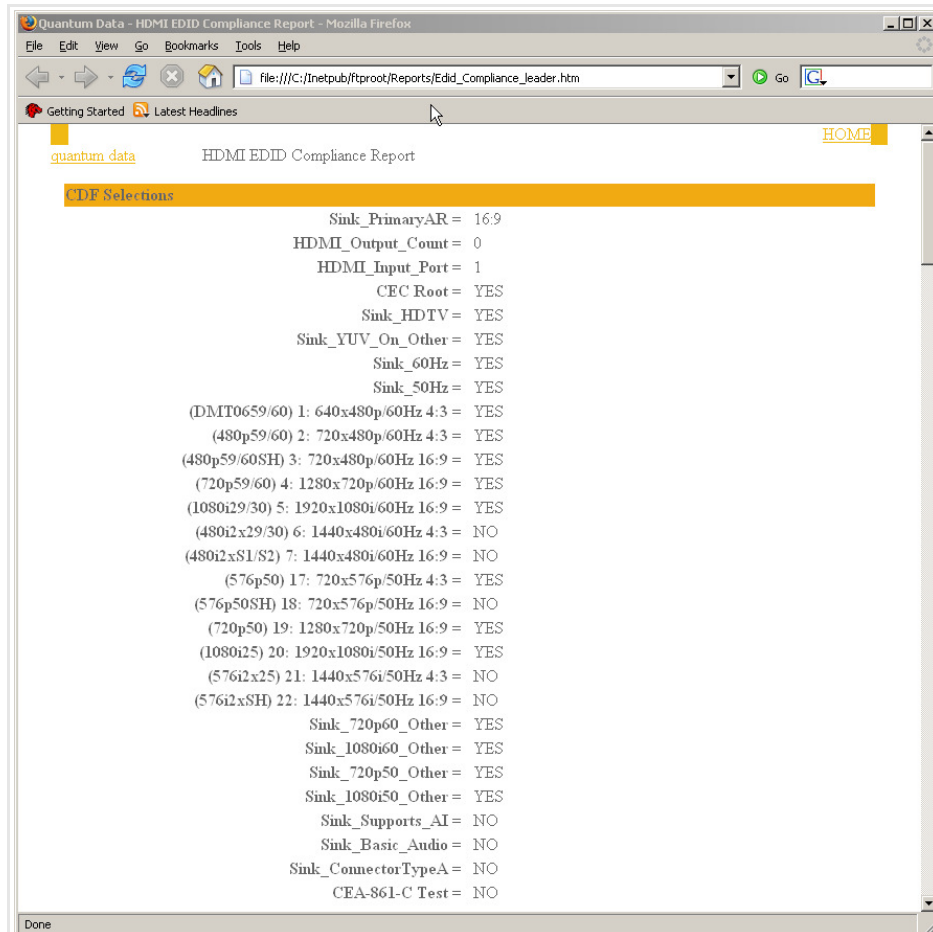

Running the HDMI EDID Compliance using the Compliance Controller

Follow the procedure below to run the EDID HDMI compliance test using the Compliance Controller (available in release 2.18 or later). Prior to running this test you will need to configure the 882 for the test. Refer to [“Setting up 882 for HDMI sink device EDID compliance testing”](#) on page 334 for instructions on setting up the 882 for the EDID test.

To run the EDID HDMI compliance test using the Compliance Controller:

1. Open a Web browser (such as Internet Explorer) and type the 882's IP address in the address entry field. For example, enter the following: `http://206.135.215.189/`

The 882 home page appears in the browser.



2. Launch the Compliance Controller by clicking on the **Compliance Controller** link. The Compliance Controller appears as shown below.



3. Select the **EDID** tab.
4. Define the capabilities declaration form for the sink device you are going to test by selecting (checking) off the parameters that are supported by the sink device you are testing.

Refer to [“Defining the capabilities of the display device under test”](#) on page 330 for information on the EDID parameters used in defining the CDF.

5. (Optional) You can expedite the CDF definition process by reading the EDID directly from the display device under test using the **Auto Generate CDF** feature.



Please note however that the specifications of the display may differ from the implementation. That is the purpose in running the test. Using the Auto Generate CDF feature is a way of populating the CDF form with a configuration that is at least quite similar to the specification.

6. Click the **Use CDF** activation button located at the bottom of the interface, to load the CDF defined in the screen for use in the test.



7. Click the **Run Test** activation button to run the EDID compliance test.
The test runs without interruption.
8. Select the Report tab on the Compliance Controller interface to view the list of reports as shown below.



9. Click on the EDID Compliance report you wish to view.

The report is display in the browser window as shown below.

The screenshot shows a web browser window with a navigation bar containing 'CEC', 'HDCP', 'EDID', and 'Reports'. The main content area features the 'quantumdata' logo and the title 'HDMI EDID Compliance Report' with a timestamp 'Aug 22 2008 [10:24:44]'. Below this, there are two main sections: 'Generator Information' and 'CDF Selections'. The 'Generator Information' section lists: Model = 882E, Unit Revision = A, Unit SN = 07020023, Date = 02152007, and Firmware = 20.1886200. The 'CDF Selections' section lists various sink parameters and supported video modes, such as Sink_PrimaryAR = 16:9, Sink_HDTV = YES, and several video modes like (DMT0659/60) 1: 640x480p/60Hz 4:3 = YES.

Generator Information	
Model	= 882E
Unit Revision	= A
Unit SN	= 07020023
Date	= 02152007
Firmware	= 20.1886200

CDF Selections	
Sink_PrimaryAR	= 16:9
HDMI_Output_Count	= 0
HDMI_Input_Port	= 1
CEC_Root	= NO
Sink_HDTV	= YES
Sink_YUV_On_Other	= NO
Sink_60Hz	= YES
Sink_50Hz	= NO
(DMT0659/60) 1: 640x480p/60Hz 4:3	= YES
(480p59/60) 2: 720x480p/60Hz 4:3	= YES
(480p59/60SH) 3: 720x480p/60Hz 16:9	= YES
(720p59/60) 4: 1280x720p/60Hz 16:9	= YES
(1080i29/30) 5: 1920x1080i/60Hz 16:9	= YES
(480i2x29/30) 6: 1440x480i/60Hz 4:3	= NO
(480i2xS1/S2) 7: 1440x480i/60Hz 16:9	= NO

Verifying pixel encoding and rate support

For test IDs 8-19 and 8-20, visual inspection of display under test is necessary to ensure proper support of pixel encoding sampling and minimum and maximum pixel clock rates using different formats. Test ID 8-19 involves testing each format with both YCbCr 4:4:4 and YCbCr 4:2:2 pixel sampling, while test ID 8-20 requires testing each format listed in the EDID at both minimum and maximum pixel clock frequencies permitted by the source device. Pixel clock rate values are as follows:

- For 50 Hz formats, the values are 49.75 Hz and 50.25 Hz (50 Hz \pm 0.5%).
- For 59.94 Hz or 60 Hz formats, the frequencies are 59.64 Hz (59.94 Hz $-$ 0.5%) and 60.3 Hz (60Hz $+$ 0.5%).
- The tested pixel clock frequency accuracy shall be \pm 0.05%

To support this testing, a list of SVD formats are provided in the Source list. For **pixel encoding** testing, the format naming nomenclature used is shown below:

Example

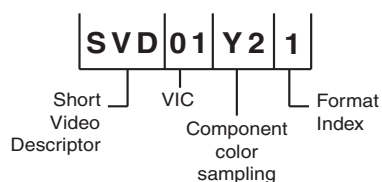

- **SVD** – Short Video Descriptor
- **01** – EIA/CEA-861-C Format Video Identification Code (for example, 01, 02, 06, etc., listed on page 149)
- **Y2** – Y indicates color difference. 2 = 4:2:2 pixel sample encoding. 4 = 4:4:4.
- **1** – Represents DMT0659 format, which is the first format (index 1) listed under video identification code 01 in the table on page 267.

For **pixel rate** testing, the format naming nomenclature used is shown below:

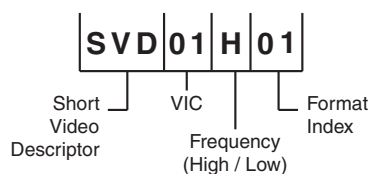

- **SVD** – Short Video Descriptor
- **01** – EIA/CEA-861-C Format Video Identification Code (for example, 01, 02, 06, etc., listed on page 267)
- **H** – Indicates the format is using the maximum (H = High) frequency required by the compliance test; L indicates the format is using the minimum (L = Low) frequency required by the compliance test.
- **01** – Represents the index of the format as listed under video identification code on page 267.

To verify proper pixel encoding and pixel rate support:

1. Connect the 882 to the display under test.
2. Press the **Sink** key. The following information appears on the 882's display.

```
Manufacturer:SNY
Product Code:144
Serial#:7011007
Week:20 Year:1998
```

3. Press the **Options** key. The following information appears on the 882's display.

-EDID Formats	CDF 
+HP Bypass	
-Emulate	

4. Choose the **EDID Formats** item by pressing the adjacent soft key. A + appears next to EDID Formats, indicating it is enabled.

The 882 loads the Source list with formats supported by the connected display (hot-plug formats read via EDID structure of attached display).

5. Press the **Content** key. The following information appears on the 882's display.

Acer1	Acer2
Acer3	Acer4
Acer5	Acer6
Acer7	Acer8

6. Select an image suitable for testing the display type (such as **Master**) by pressing the soft key adjacent to the image.

Alternatively, to select the image using the command line interface, enter the following command:

```
IMGL Master  
IMGU
```

7. Press the **Source** key and select a format beginning with SVD by pressing the adjacent soft key.
8. On display under test, verify format displays image properly.
9. Repeat steps 7 and 8 to test each SVD format.

Using the EDID Editor tool

The 882 provides an EDID Editor Tool. This tool is useful for creating, modifying, and saving EDIDs, as well as applying EDIDs to HDMI emulator ports for source testing.

Using the EDID Editor Tool involves the following basic steps:

1. Loading an EDID into the Editor. An EDID is loaded from a file stored on the 882 file system or host PC, or by capturing and loading an EDID from a display connected to the 882x HDMI or VGA interface.
2. Modifying EDID settings using the tool's user-friendly graphical interface. Operations are accomplished using check boxes, text fields and pull-down list boxes with human readable field descriptions and value options.
3. Saving a modified EDID to a file stored on the 882 file system or host PC, and/or by putting (writing) the EDID on a display connected to the 882CA or 882EA HDMI interface (display must have writable EEPROM).
4. For source testing, applying an EDID to one of the HDMI DisplayPort Rx ports for emulation.

Note: When creating EDIDs for source testing (for computer monitors in the IT market or TV displays in the CE market), it is important to understand the specifications which define the structure of the EDID you are creating. The EDID structure is defined by VESA and the extensions are defined by the CEA in the 861 specification.

Loading EDIDs with the EDID Editor

The procedure below provides instructions on loading EDIDs into the EDID Editor Tool.

To load an EDID:

1. Make appropriate cable connection as follows:
 - If you are capturing and loading an EDID from an HDMI display, connect an HDMI-to-HDMI cable between the HDMI OUT connector on the 882 and the HDMI connector on the display under test.
 - If you are loading an EDID from one of the HDMI Rx ports on the 882, connect an HDMI-to-HDMI cable between the HDMI Tx connector on the 882 and the HDMI Rx input ports that is configured with the EDID you wish to load.

2. Activate the HDMI-H interface on the output port:

- a. Press the **Interface** key to access the list of interfaces. A listing of signal interfaces appears on the 882's display as shown below.

* VGA	CVBS
HDMI-D	S-VIDEO
HDMI-H	SDI

- b. Choose the **HDMI-H** item by pressing the adjacent soft key.

The interface is activated and the port outputs the currently selected image and format.

VGA	CVBS
HDMI-D	S-VIDEO
*HDMI-H	SDI

Alternatively, to select the interface through the command line, enter the following commands:

```
XVSI 4 // Selects the HDMI-H interface
ALLU // Applies the interface setting to the 882
```

3. Press the **Source** key and choose a valid HDMI format (for example, DMT0660) by pressing the adjacent soft key.

Alternatively, to select the format through the command line interface, enter the following command:

```
FMTL DMT0660
FMTU
```

4. Open a Web browser (such as Internet Explorer) and type the 882's IP address in the address entry field. For example, enter the following: `http://206.135.215.189/`
The 882 home page appears in the browser.



5. Click the **EDID Editor** link. The EDID Editor appears as shown below.

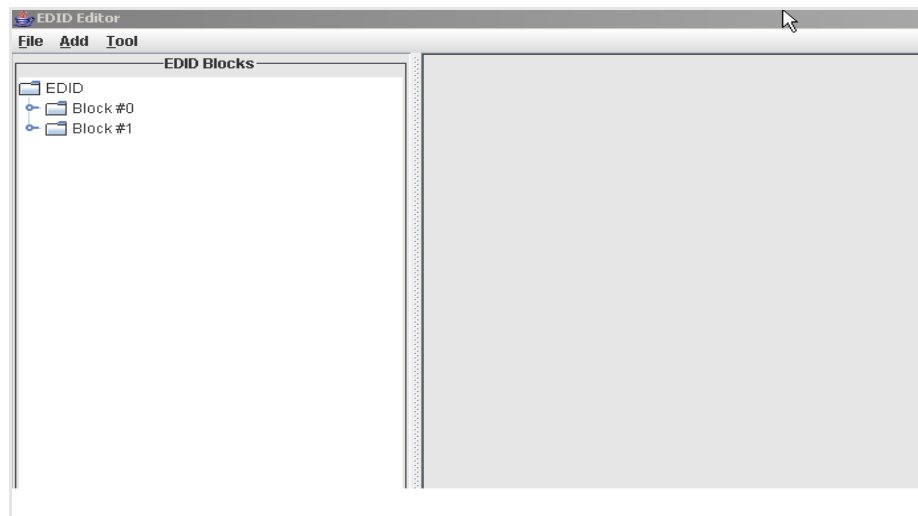

Note: The EDID Editor is provisioned with the default Quantum Data EDID when opened.

6. Choose the EDID you want to load into the Editor. You can load EDIDs from a connected device, the 882 file system, or from your PC. The following table describes what selection ports map to which physical interface:

Load EDID From...	Location
882	A valid EDID XML file stored on the 882 file system (in flash memory or on the PC card).
Device connected to 882	A device that is connected either to the 882's HDMI Tx ports or the VGA port: - 882 Analyzer Port 1 - HDMI - 882 Analyzer Port 2 - HDMI - 882 Analyzer Port 3 - VGA
File on PC	A valid EDID XML file stored in the host PC.

- a. If you are loading an EDID XML file stored on the 882 generator, select **Load EDID From > 882** from the **File** menu. Select a valid file.

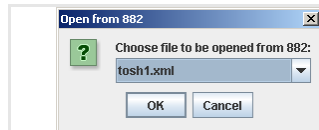

The EDID is loaded into the Editor.

- b. If you are capturing and loading an EDID from a connected display device, select **Load EDID From > Device Connected to > 882 Analyzer Port <x>** from the **File** menu. (Port 1 is HDMI Tx 1, Port 2 is HDMI TX 2, and Port 3 is VGA.)

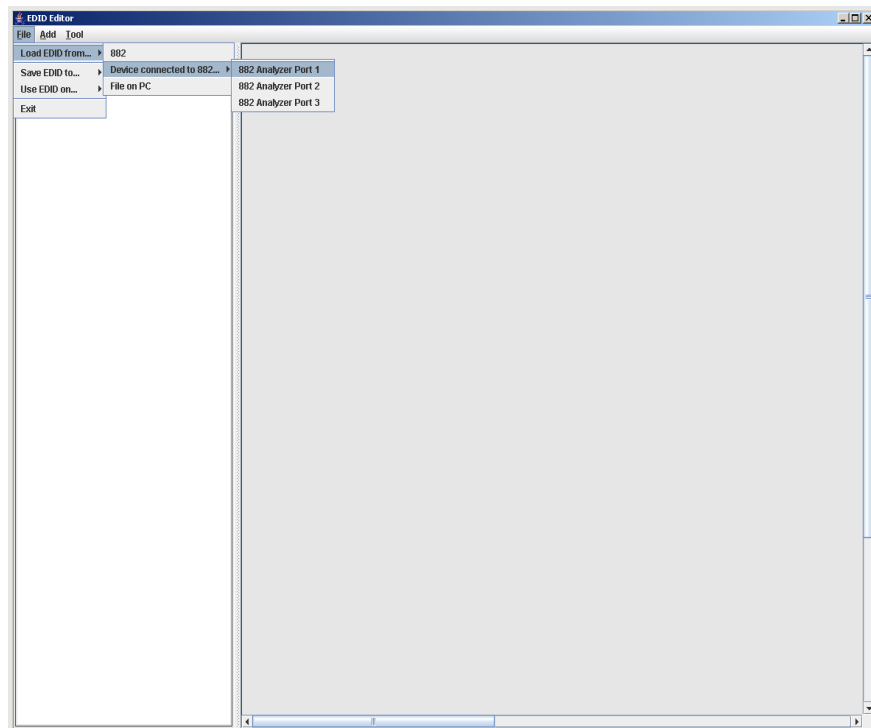

- c. If you are loading an EDID XML file stored on the host PC, select **Load EDID From > File on PC** from the **File** menu. Select a file.

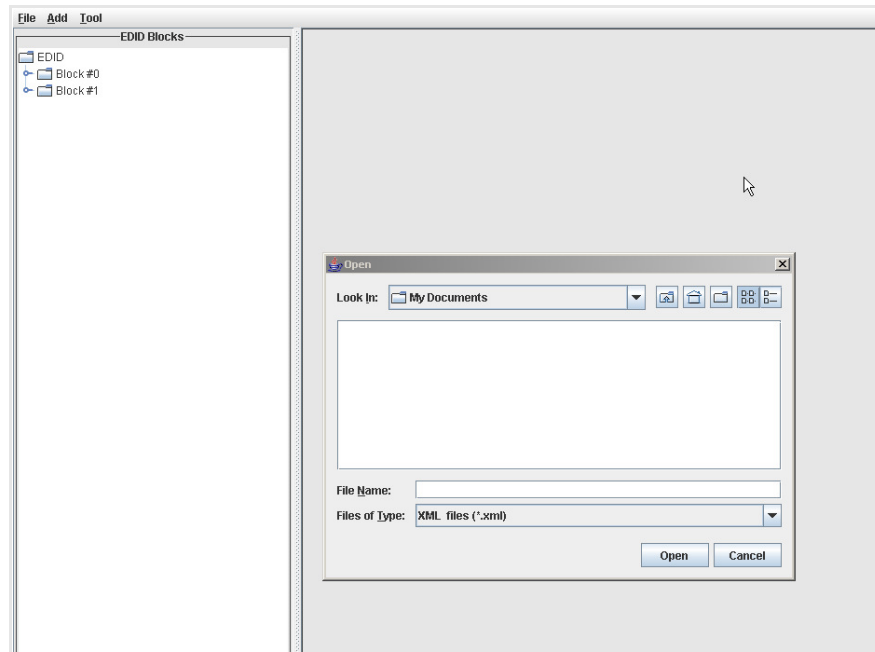

The EDID is loaded into the Editor.

Editing an existing EDID

The procedure below provides instructions on editing EDIDs in the EDID Editor Tool.

To edit an existing EDID:

1. Open the EDID Editor and load an EDID using the procedures described in “[Loading EDIDs with the EDID Editor](#)” on page 352.

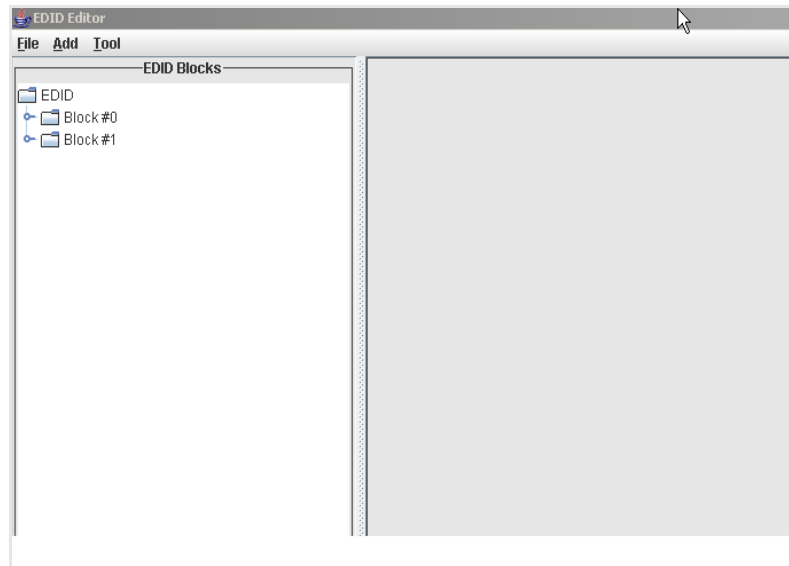

2. Expand the EDID Block in the navigation view.

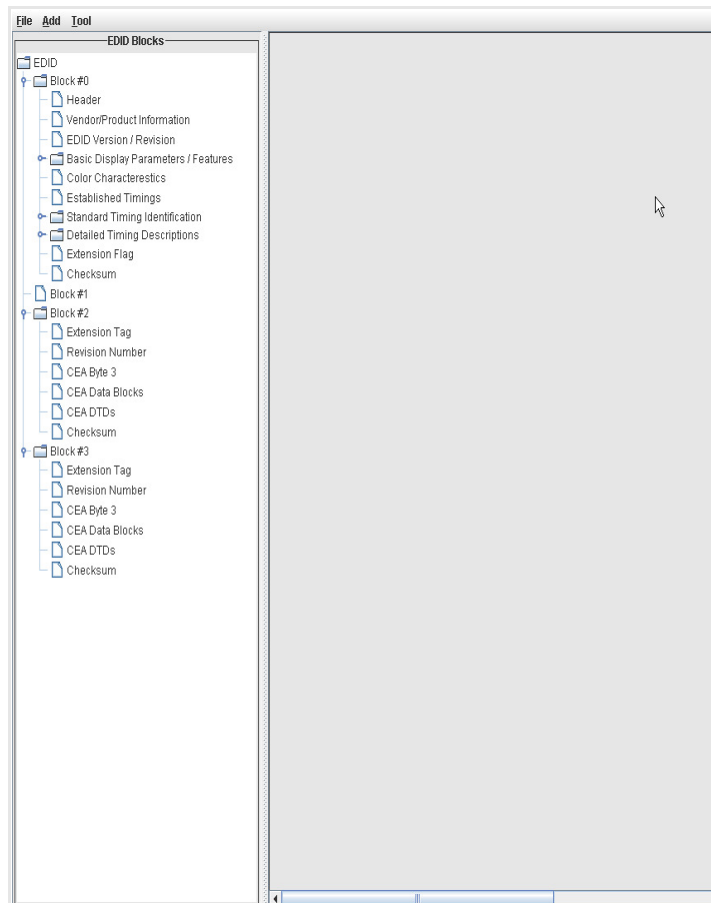

3. Double-click on the EDID data blocks you wish to edit.

Edit the pull-down select boxes, text fields and check boxes in accordance with the requirements of the EDID you are creating. The screen shot below shows a typical dialog box for editing the Timing Descriptor Detailed Timing Descriptor. Make sure to click on the **OK** button when you have completed the edits for each dialog box.

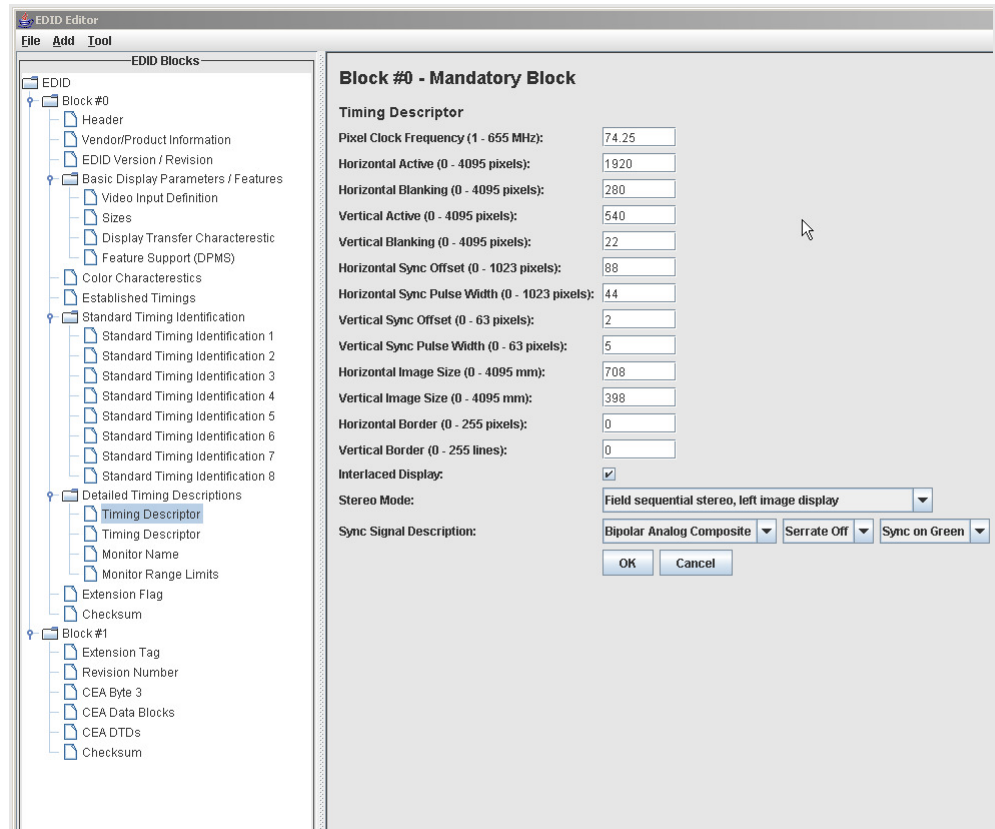

4. Save the modified EDID using the procedures described in “[Saving an EDID to a file](#)” on page 368.

Creating a new EDID

The procedure below provides instructions on creating a new EDID in the EDID Editor Tool. This procedure shows how you would create a new, 4-block EDID from the default Quantum Data 2-block EDID.

Note: To create a new EDID, you will need to obtain all the information for the various fields in the EDID.

To create a new EDID:

1. Open the EDID Editor and load the EDID using the procedures “[Loading EDIDs with the EDID Editor](#)” on page 352.

Upon power up the HDMI Rx ports are configured with the Quantum Data 2 block EDID.

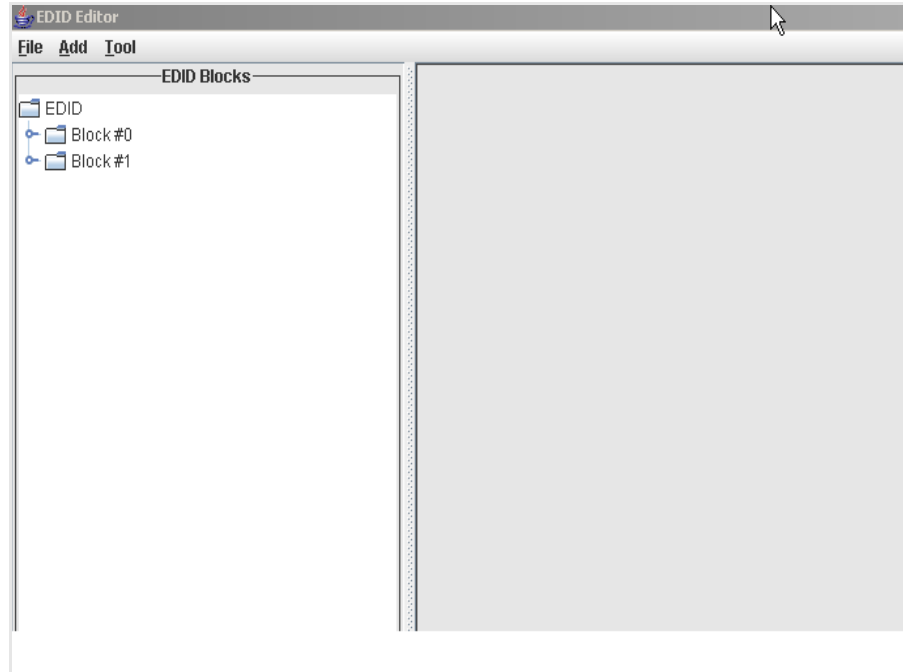

2. Expand the EDID Block in the navigation view.

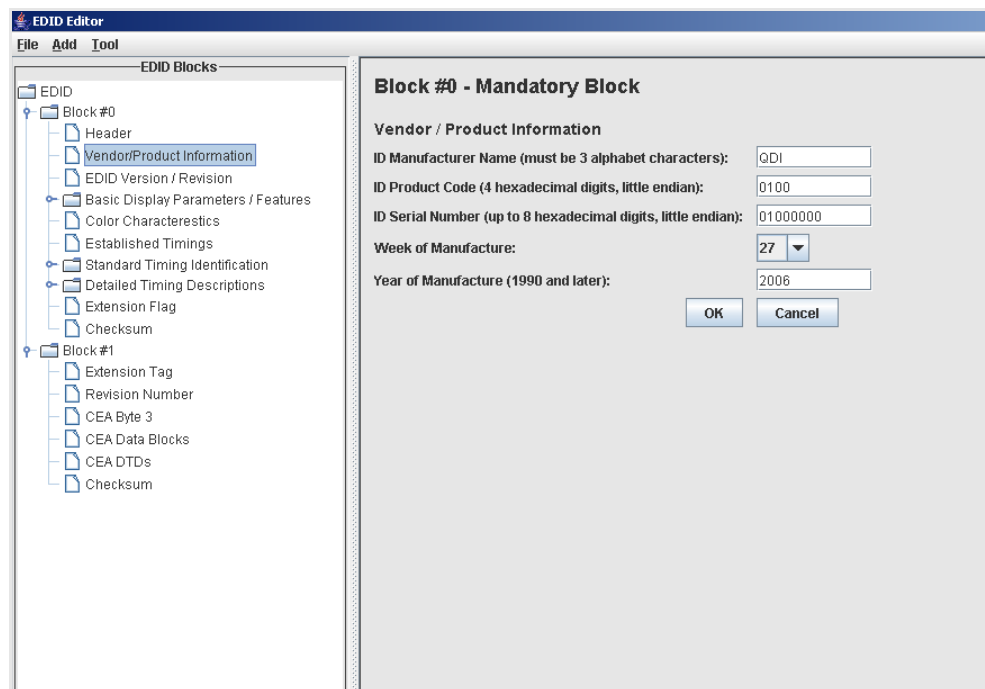

3. Edit the fields in Block#1 in accordance with your requirements.

This screen shows the Vendor/Product Information screen where you will need to make some edits. When you change the value of any field (either a free form text field, pull-down select box or check box), make sure to click the **OK** button to invoke the change. If you make a change by mistake, click on the **Cancel** button.

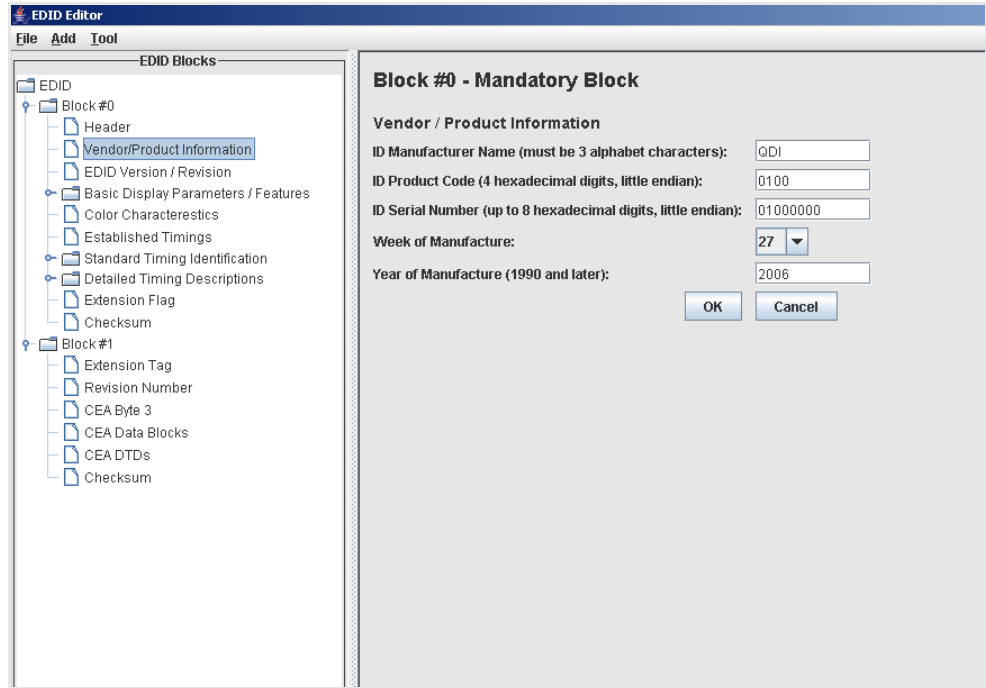

4. Add the CEA extension blocks by selecting **New CEA Block** from the **Add** pull down menu as shown below.

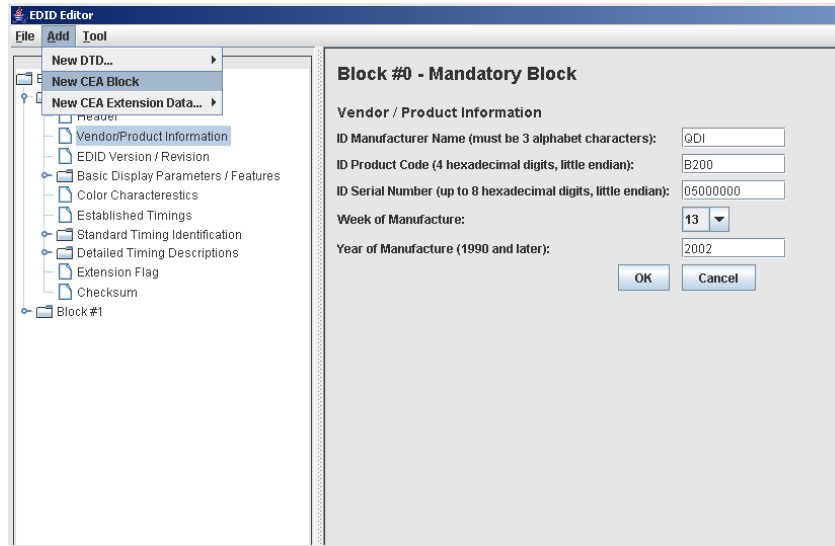

When you add a CEA block, both Block #2 and Block #3 are added. In addition, the **Extension Flag** field in Block #0 is updated with the value of 3.

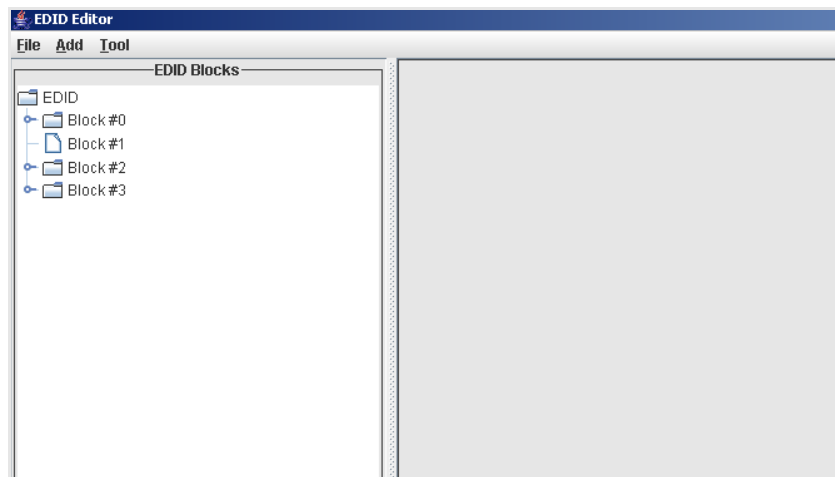

5. Add a CEA extension data block.
 - a. Highlight the CEA Data Block where you want to add the extension block.
 - b. Select **New CEA Extension Blocks** from the **Add** pull down menu.

The example below shows adding a CEA Video Data Block.

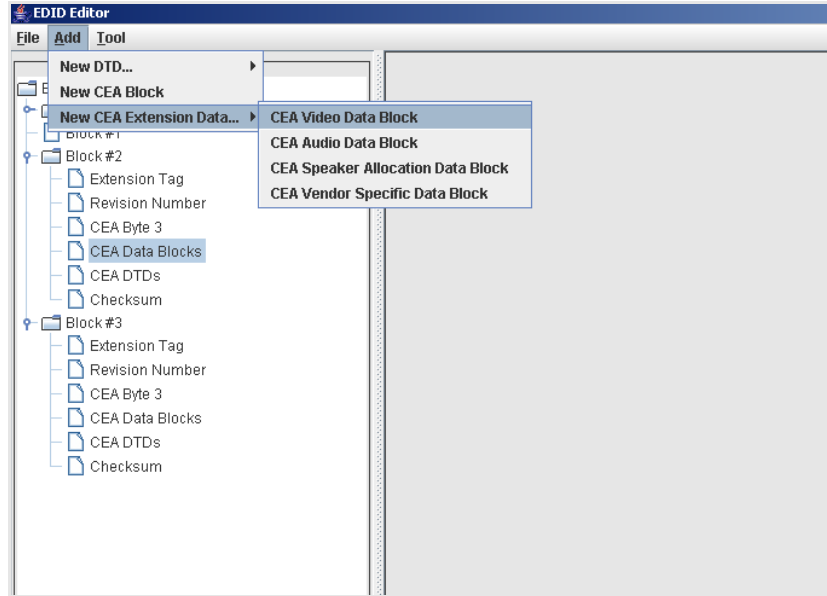

When you add a CEA extension block, it is added to the selected CEA data block as shown below.

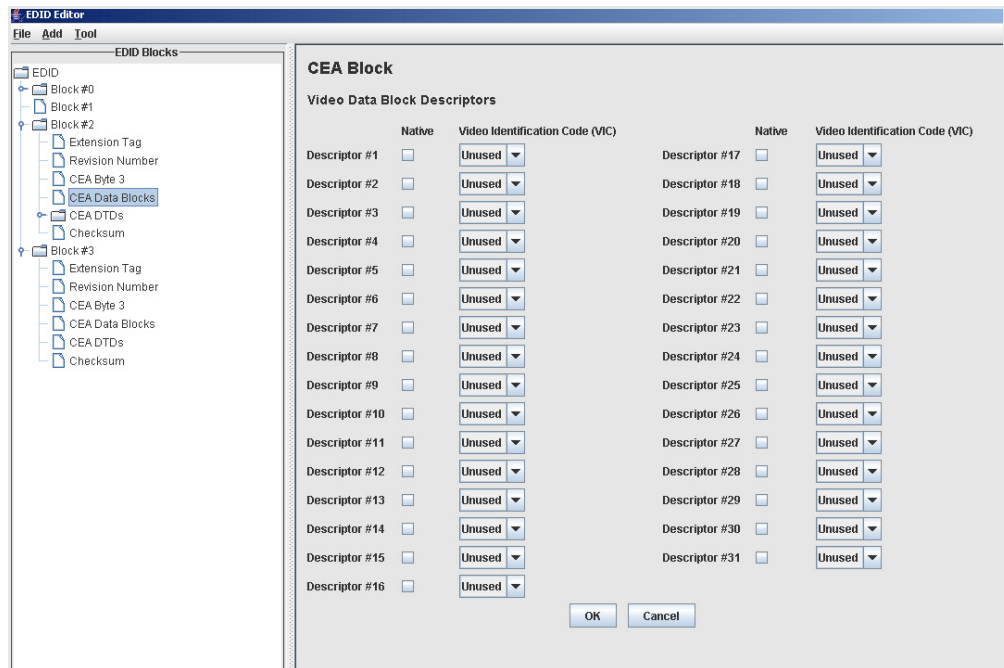

- c. Edit the fields in the data block in accordance with your requirements.

d. Click the **OK** button to save the data block that you added.

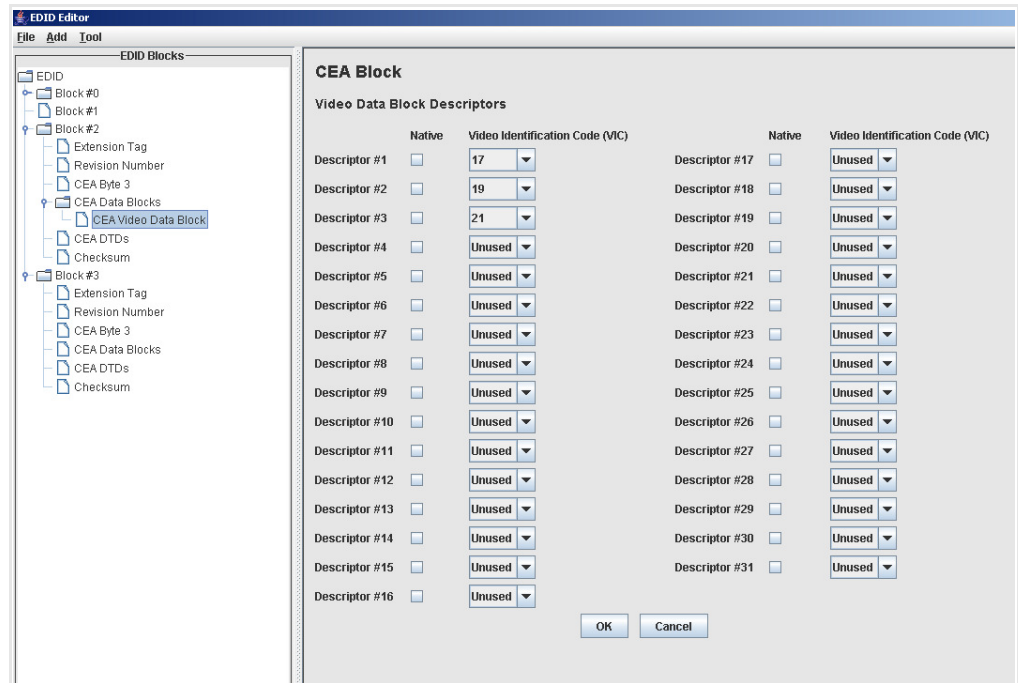

6. Add detailed timing descriptor (DTD) data.
 - a. Highlight the CEA DTDs block where you want to add the DTD.
 - b. Select **New DTD** from the **Add** pull down menu.

The example below shows adding a Custom Timing Descriptor.

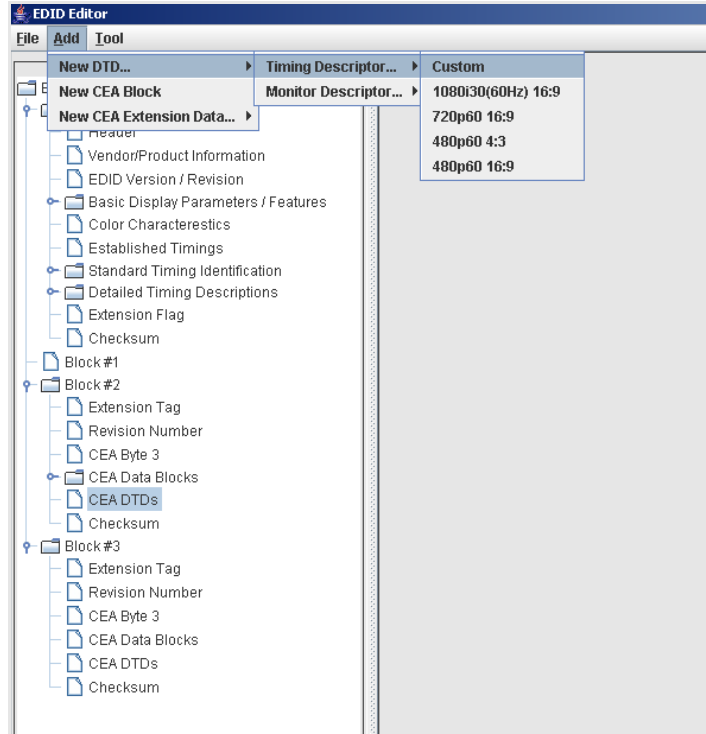

When you add a DTD, it is added to the selected DTD data block as shown below.

- c. Edit the fields in the data block that in accordance with your requirements.
- d. Click the **OK** button to save the data block that you added.

7. Add a vendor specific data block.
 - a. Highlight the CEA Data block where you want to add the Vendor Specific Data block.
 - b. Select **New CEA Extension Data** from the **Add** pull down menu.

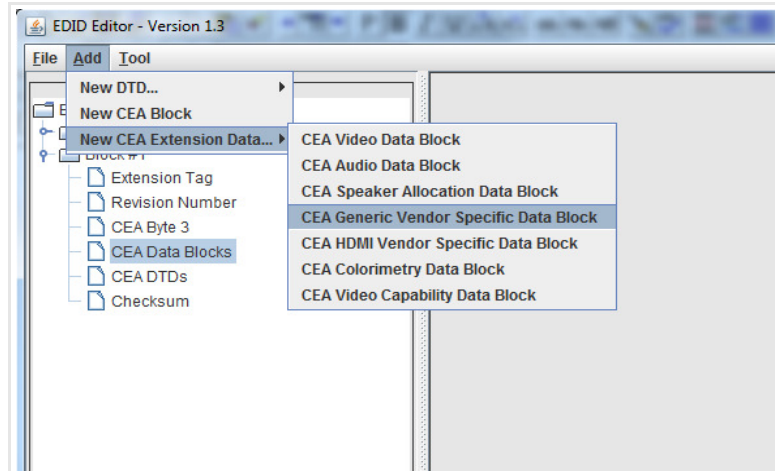

Use the check boxes and data entry fields to specify the data in the vendor specific data block as shown below.

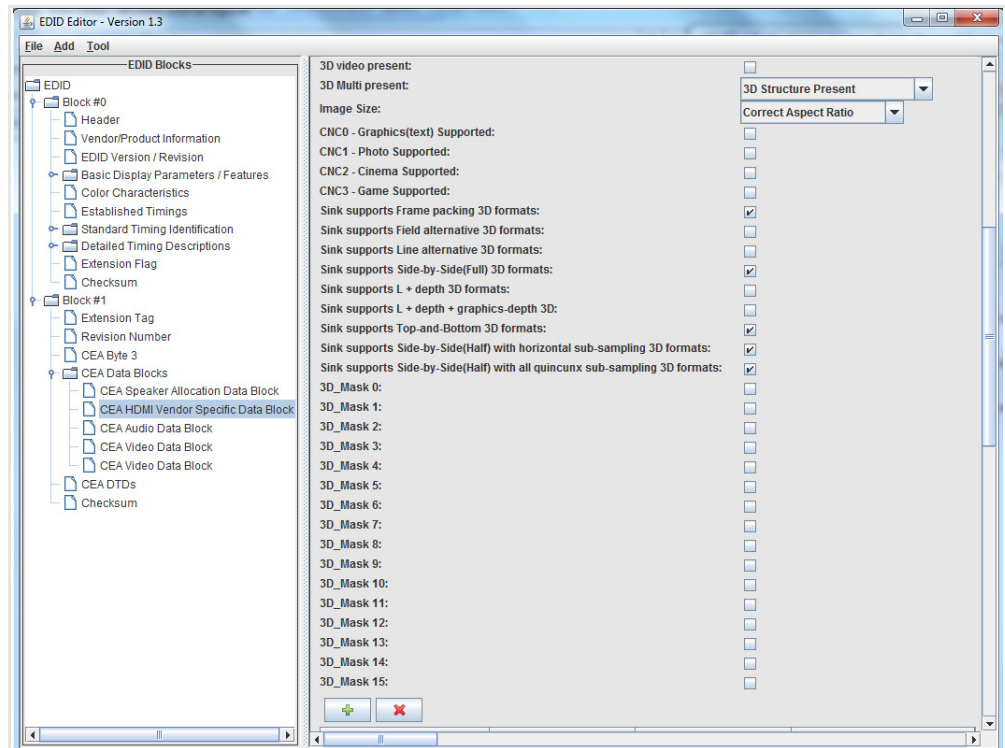

8. (Optional) If you need to delete an item such as a CEA extension block or data block, select the block in the EDID Blocks window, then select **Delete Selected Item** from the **Tools** pull-down menu as shown below.

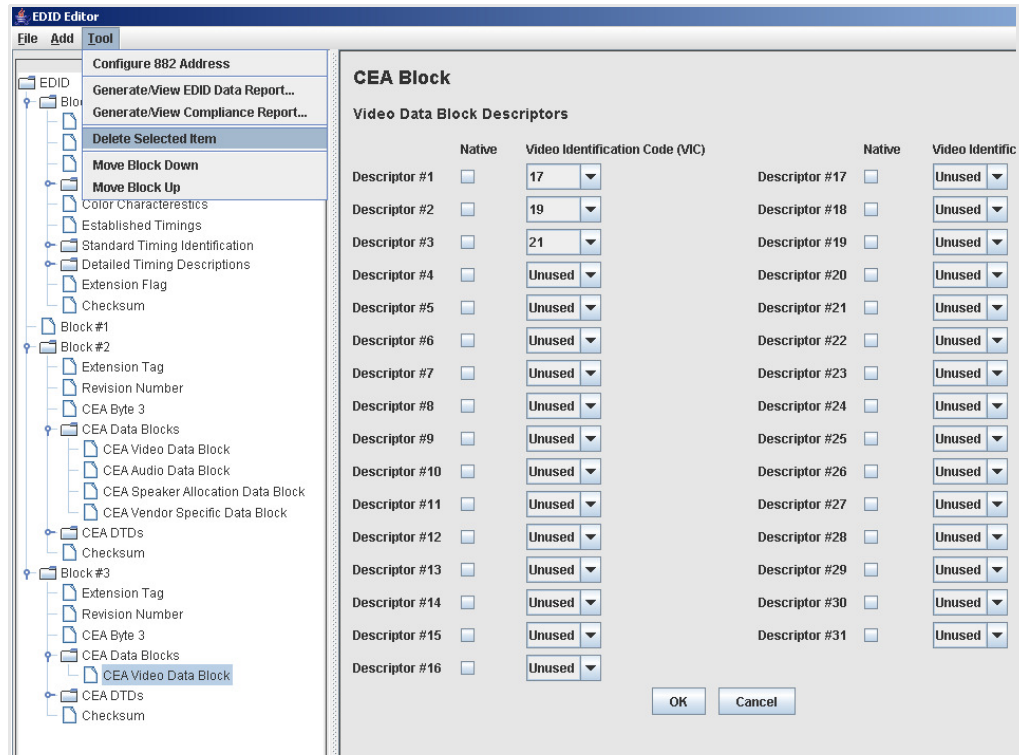

9. Complete your edits by double clicking on the EDID data blocks you wish to modify.

Edit the pull down select boxes, text fields and check boxes in accordance with the requirements of the EDID you are creating. The screen shot below shows a typical dialog box for editing the Timing Descriptor Detailed Timing Descriptor.

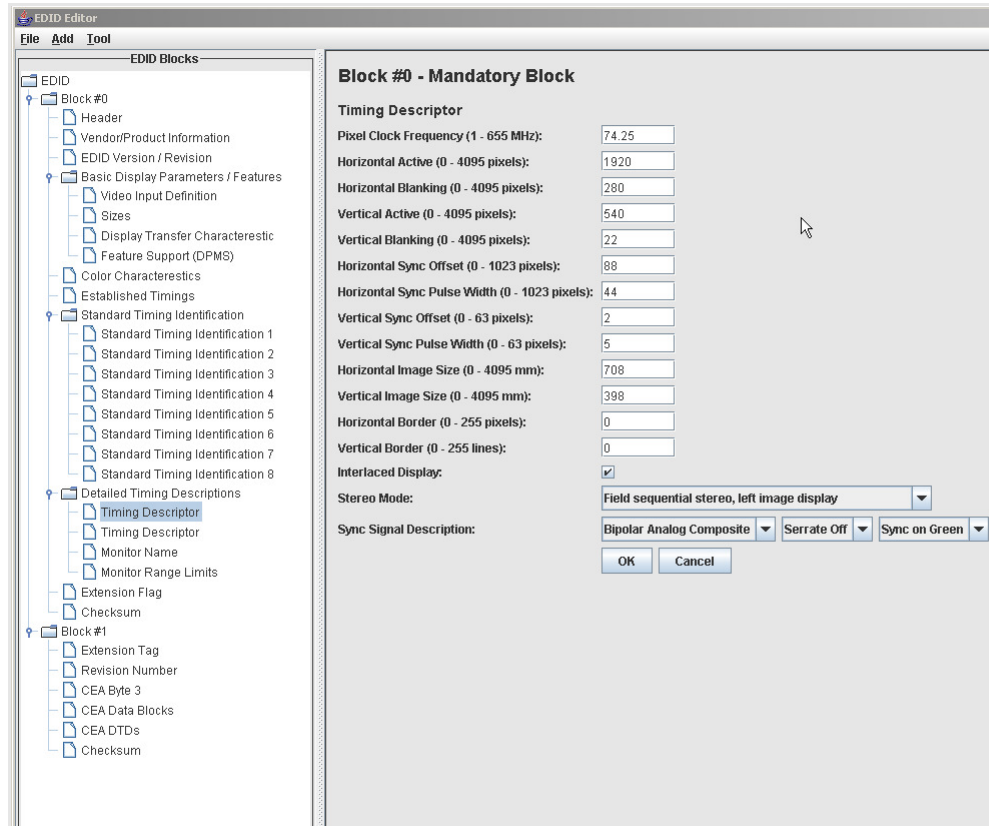

10. Save the modified EDID using the procedures described in “[Saving an EDID to a file](#)” on page 368.

Saving an EDID to a file

The procedure below provide instructions on saving an EDID to an EDID XML file used by the 882 generator.

To save an EDID to a file:

1. If not already loaded in the Editor, load the EDID using the procedure “[Loading EDIDs with the EDID Editor](#)” on page 352.

2. Select **Save EDID to...** from the **File** pull down menu as shown below.

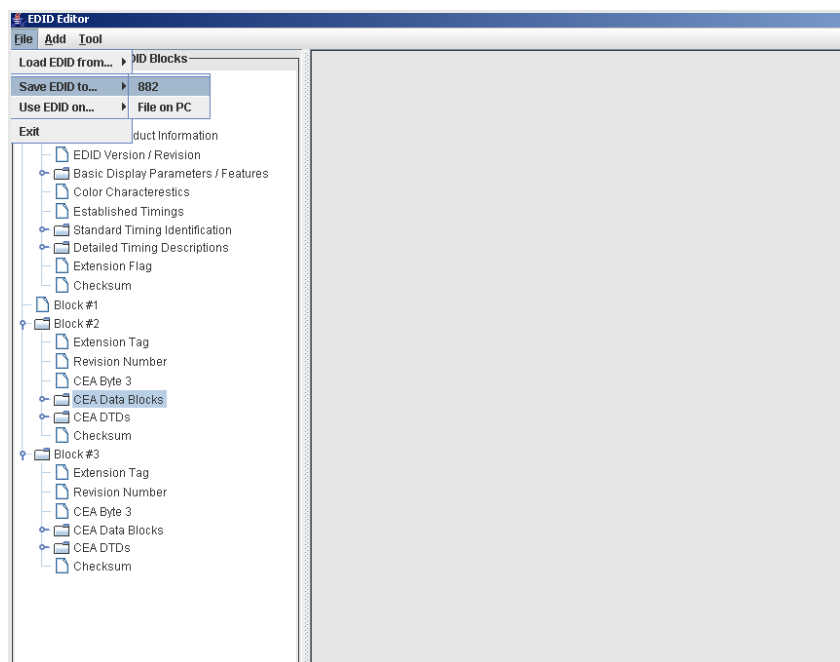

3. Select the location you want to store the file.
 - a. If you are saving the EDID to the 882 file system, select **882** and enter a filename. The EDID XML file is stored in flash memory.
 - b. If you are saving the EDID to the host PC, select **File on PC** and enter a filename. The EDID XML file is stored on the PC.

The EDID is saved to a EDID XML file used by the 882 generator.

Putting (Writing) EDID to a display

Note: The connected display device must have writable EEPROM to use this feature.

Important: This procedure will overwrite the EDID contents of your display device.

The procedure below provide instructions on putting (writing) an EDID to a display device connected to one of the 882's HDMI Tx ports.

To put (write) an EDID to a connected display device:

1. If not already connected, connect an HDMI-to-HDMI cable between the OUT connector on the 882 and the HDMI connector on the display device.

2. Activate the HDMI-H interface on the output port:
 - a. Press the **Interface** key to access the list of interfaces. A listing of signal interfaces appears on the 882's display as shown below.
 - b. Choose the **HDMI-H** item by pressing the adjacent soft key.

The interface is activated and the port outputs the currently selected image and format.

Alternatively, to select the interface through the command line, enter the following commands:

```
XVSI 4          // Selects the HDMI-H interface
ALLU           // Applies the interface setting to the 882
```

3. Activate the DisplayPort interface on the output port by selecting the **DisplayPort** item with the adjacent soft key.

Alternatively, to select the interface through the command line, enter the following commands:

```
XVSI 10         // Selects the DisplayPort interface
ALLU           // Applies the interface setting to the generator
```

4. If not already loaded in the Editor, load the EDID using the procedure "[Loading EDIDs with the EDID Editor](#)" on page 352.
5. Select **Save EDID to... > Device connected to 882... > 882 Analyzer Port <x>** from the **File** menu. (Port 1 is HDMI Tx 1, and Port 2 is HDMI Tx 2.)

The EDID is written to the writable EEPROM on the display device.

Emulating an EDID

The procedures below provide instructions on configuring one of the analyzer ports to emulate an EDID that you have loaded in the Editor tool. You can configure the port either or both HDMI Rx ports with any viable EDID .xml file that you have stored.

To emulate an EDID:

1. Load an existing EDID using the procedures described in "[Loading EDIDs with the EDID Editor](#)" on page 352.

2. Select **Use EDID on...** from the **File** pull down menu.

The example below shows how you would configure the EDID loaded into the editor on HDMI Rx port 1.

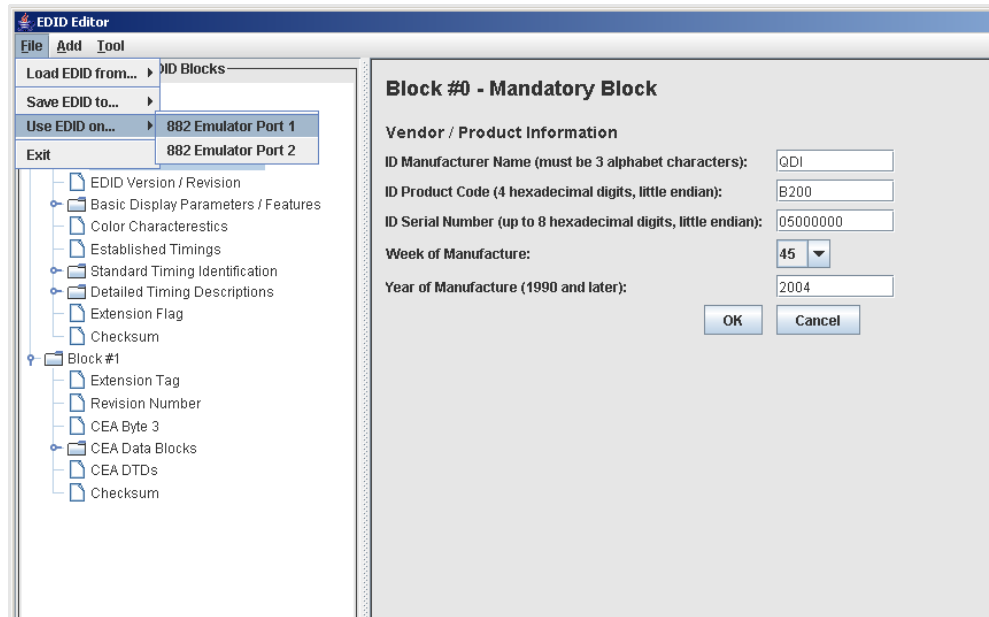

The EDID that was loaded into the EDID Editor tool is now configured on the HDMI Rx port you selected (882 HDMI Rx 1 port in the example above).

Running an EDID HDMI compliance test

You can run the EDID HDMI compliance test on an HDMI EDID that is loaded into the EDID Editor. When you run the test, the tool automatically generates the HTML report as well. When you run this test the CDF that is used is the one that is currently saved in the 882. The procedures below provide instructions on running the EDID HDMI compliance test from the EDID Editor.

To run an EDID HDMI compliance test:

1. Load an existing EDID using the procedures described in [“Loading EDIDs with the EDID Editor”](#) on page 352.
2. Configure the CDF in accordance with the procedures in [“Testing HDMI sink device for EDID compliance”](#) on page 330.

3. Select **Generate/View Compliance Test** from the **Tools** pull down menu as shown below.

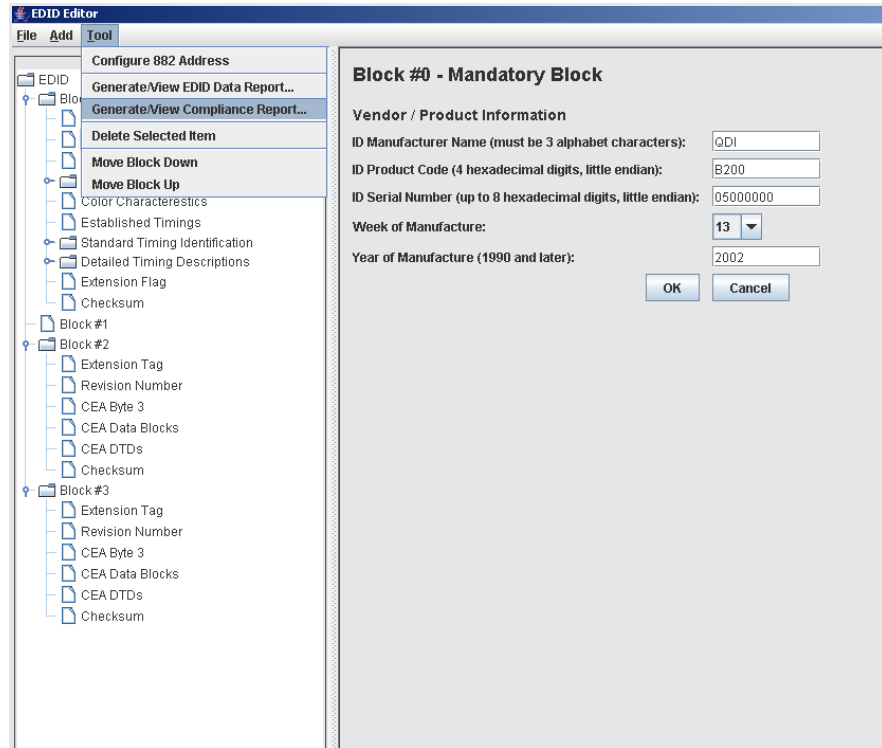

The EDID HDMI Compliance test report appears in the window.

Running an EDID data report

You can run the EDID data report in an HDMI EDID that is loaded into the EDID Editor. This function generates an HTML report that appears in the window when complete. The procedures below provide instructions on running the EDID data report from the EDID Editor.

To run an EDID data report:

1. Load an existing EDID using the procedures described in [“Loading EDIDs with the EDID Editor”](#) on page 352.

2. Select **Generate/View Compliance Test** from the **Tools** pull down menu as shown below.

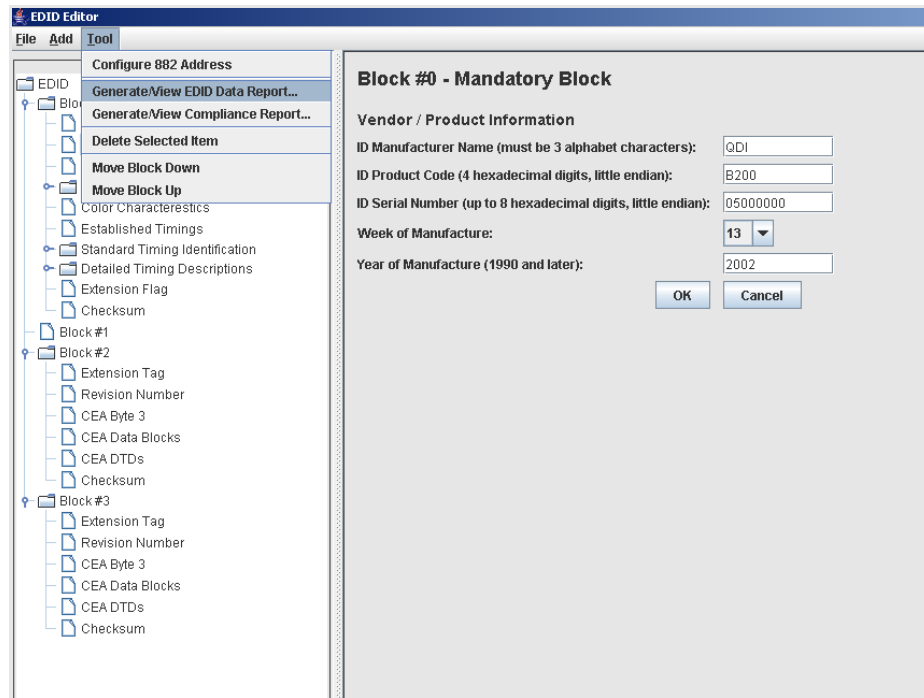

The EDID report appears in the window.

Using the EDID Compare tool

The 882 provides an EDID Compare tool. This tool allows you to capture an EDID from a connected display, then compare its contents to subsequent EDID readings. This allows you to verify the display device is consistently generating an identical EDID.

Comparing EDIDs

Follow this procedure to verify the display device is generating an identical EDID:

To compare EDIDs:

1. Connect an HDMI-to-HDMI cable between the HDMI OUT connector on the 882 and the HDMI connector on the display under test.
2. Open a Web browser (such as Internet Explorer) and type the 882's IP address in the address entry field. For example, enter the following: `http://206.135.215.189/`

The 882 home page appears in the browser.



3. Click the **EDID Compare Tool** link. The EDID Compare Tool appears.

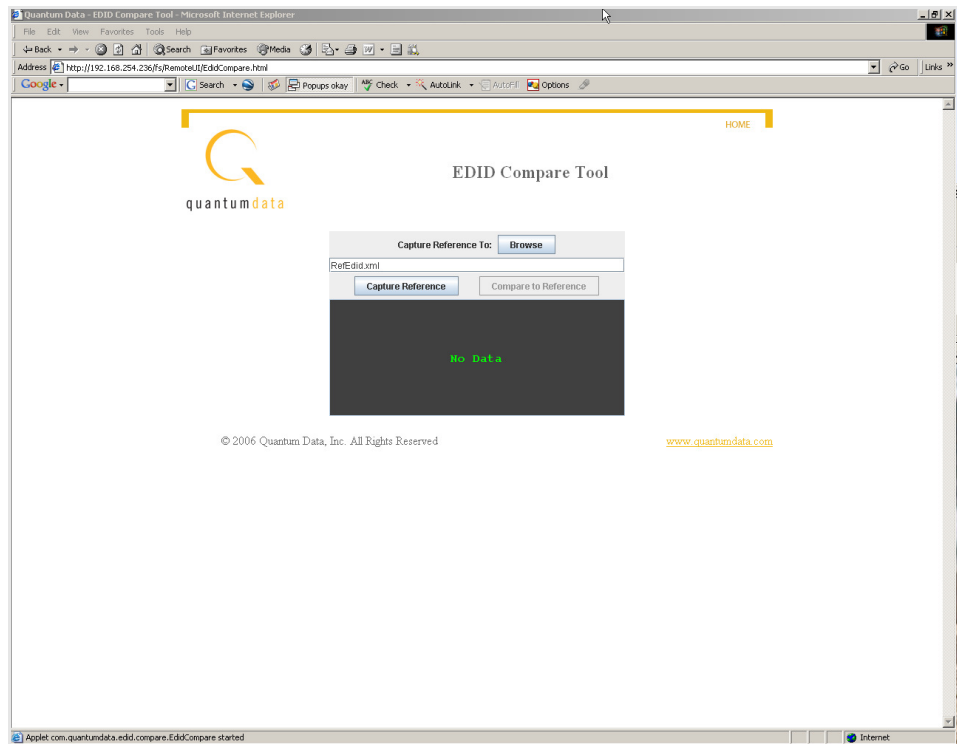

4. Click the **Capture Reference** button. The following message appears.

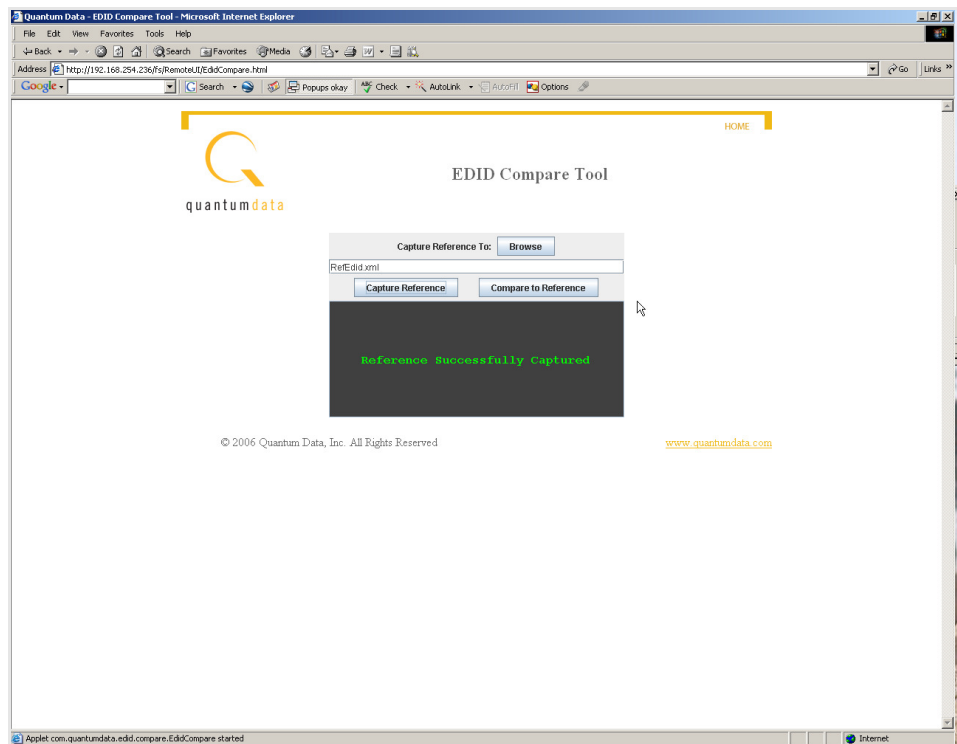

Note: You can use the tool to save a copy of the EDID onto your PC by clicking on the **Browse** button. This enables you to browse for a location on your PC and store the EDID.

5. Click the **Compare to Reference** button. The following message appears if EDID contents are identical.

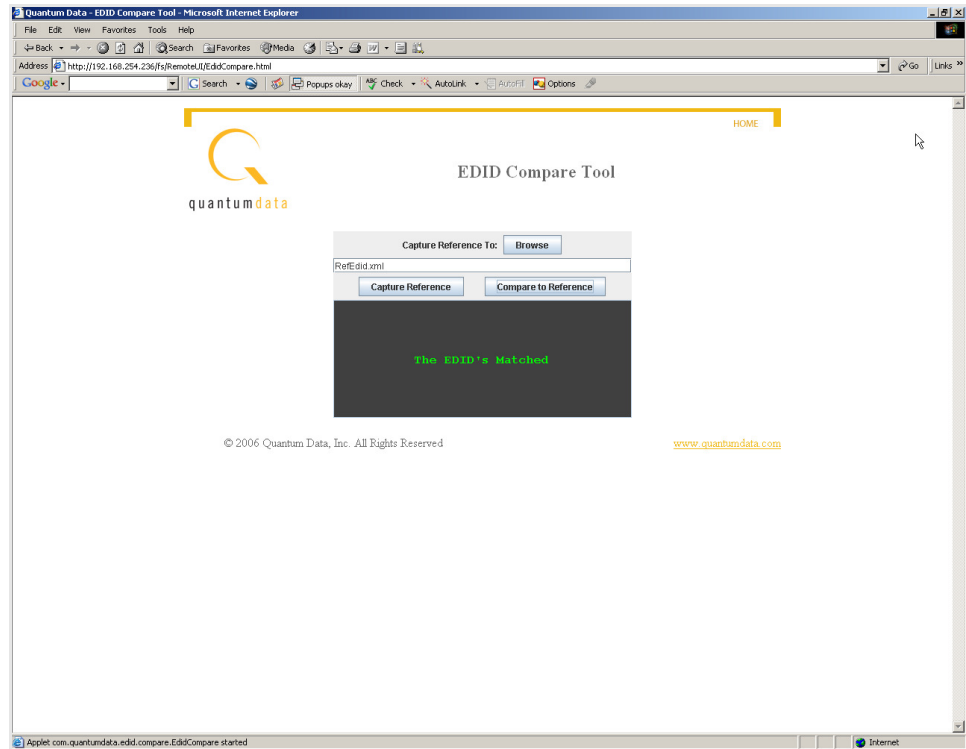

If EDID contents are not identical, you see the message **Mis-Matched EDID's** displayed.

12 Testing HDCP on HDMI

Topics in this chapter:

- [Overview](#)
- [Testing DVI displays with HDCP](#)
- [Testing HDMI displays with HDCP](#)
- [Running an HDMI HDCP self-test](#)
- [Understanding the HDCP test](#)

Overview

You can use the 882 with the High-bandwidth Digital Content Protection (HDCP) to test HDCP 1.0, 1.1 and 1.2 compliant devices. The procedures in this chapter instruct you on how to complete the HDCP tests for a DVI, HDMI or DisplayPort sink devices.

The 882E and 882C are compliant HDMI-HDCP sources. For more information about HDCP, see <http://www.digital-cp.com/>.

Testing DVI displays with HDCP

This section describes how to test DVI and HDMI receivers with HDCP.

To set up the 882 for testing a DVI display:

1. Connect an HDMI-to-DVI converter cable between the HDMI OUT connector on the 882 and the device's DVI receiver.
2. Activate the HDMI-D interface on the output port as follows:
 - a. Press the **Interface** key. A listing of signal interfaces appears on the 882's display as shown below.

* VGA	CVBS
HDMI-D	S-VIDEO
HDMI-H	SDI

- b. Choose the **HDMI-D** item by pressing the adjacent soft key. The interface is activated, and the port outputs the currently selected image and format.

Alternatively, to activate the interface through the command line interface, enter the following commands:

```
XVSI 3 // Activates the HDMI-D interface
ALLU // Applies the interface setting to the 882
```

3. Choose a standard format (for example, DMT0660) by pressing the adjacent soft key.

Alternatively, you can load the format with the following command:

```
FMTL DMT0660
FMTU
```

- Choose the **HDCPprod** test image, or, if you are using HDMI OUT port 2, choose the **HDCP2** test image.

If you are testing a device with a production key, select the **HdcpProd** image (or, if you are using HDMI OUT port 2, choose the **HDCP2** test image). These test images assume that both the HDCP transmitter and receiver have a production key.

```

STEP 1: Reset the transmitter - PASS
STEP 2: Initialize the transmitter - PASS
STEP 3: At transmitter generate An - PASS
STEP 4: Write An to the receiver - PASS
STEP 5: Write the transmitter KSU to the receiver - PASS, Aksv = 0x91584AD36F
STEP 6: Read and verify the receiver KSU - PASS, Bksv = 0x9C116E35EA
STEP 7: Write receiver KSU to transmitter - PASS
STEP 8: Ri ready at transmitter - PASS
STEP 9: Read and compare transmitter Ri with receiver Ri - PASS
          RiTX = 0xA543
          RiRX = 0xA543
STEP 10: Generate authentication - PASS
STEP 11: Transmitting encrypted data - TESTING
  
```

The image will indicate if the test passed or failed. If the test fails, see [“Understanding the HDCP test”](#) on page 387.

- To test another device, connect the cable to the new device.

The HDCP test starts automatically.

Alternatively, you can enter the following command to initiate and run the test with any image displayed. A zero is returned if the HDCP test is successful.

```
HDCP? (OUT1:HDCP?, OUT2:HDCP?)
```

You can also specify a number of frames to run the test for. For example to run the test for 2000 frames you would enter:

```
HDCP? (OUT1:HDCP?, OUT2:HDCP?) 2000
```

Testing HDMI displays with HDCP

To test HDCP with an HDMI device:

1. Connect an HDMI cable between the HDMI OUT connector on the 882 and the HDMI display.
2. Activate the HDMI-H interface on the output port as follows:
 - a. Press the **Interface** key. A listing of signal interfaces appears on the 882's display as shown below.

* VGA	CVBS
HDMI-D	S-VIDEO
HDMI-H	SDI

- b. Choose the **HDMI-H** item by pressing the adjacent soft key. The interface is activated and the port outputs the currently selected image and format.

Alternatively, to activate the interface through the command line interface, enter the following commands:

```
XVSI 4          // Activates the HDMI-H interface
ALLU           // Applies the interface setting to the 882
```

3. Choose a standard format (for example, DMT0660) by pressing the adjacent soft key.

Alternatively, you can load the format with the following command:

```
FMTL DMT0660
FMTU
```

4. Choose the **HDCPprod** test image, or, if you are using HDMI OUT port 2, choose the **HDCP2** test image.

If you are testing a device with a production key, select the **HdcpProd** image, or, if you are using HDMI OUT port 2, choose the **HDCP2** test image. These test images assume that both the HDCP transmitter and receiver have a production key.

```

STEP 1: Reset the transmitter - PASS
STEP 2: Initialize the transmitter - PASS
STEP 3: At transmitter generate An - PASS
STEP 4: Write An to the receiver - PASS
STEP 5: Write the transmitter KSU to the receiver - PASS, Aksv = 0x91584AD36F
STEP 6: Read and verify the receiver KSU - PASS, Bksv = 0x9C116E35EA
STEP 7: Write receiver KSU to transmitter - PASS
STEP 8: Ri ready at transmitter - PASS
STEP 9: Read and compare transmitter Ri with receiver Ri - PASS
RITX = 0xA543
RIRX = 0xA543
STEP 10: Generate authentication - PASS
STEP 11: Transmitting encrypted data - TESTING
  
```

The image will indicate if the test passed or failed. If the test fails, see [“Understanding the HDCP test”](#) on page 387.

5. To test another device, connect the cable to the new device.

The HDCP test starts automatically.

Alternatively, you can enter the following command to initiate and run the test with any image displayed. A zero is returned if the HDCP test is successful.

```
HDCP? (OUT1:HDCP?, OUT2:HDCP?)
```

You can also specify a number of frames to run the test for. For example to run the test for 2000 frames you would enter:

```
HDCP? (OUT1:HDCP?, OUT2:HDCP?) 2000
```

HDCP? (OUT1:HDCP?, OUT2:HDCP?) 2000



The image will indicate if the test passed or failed. If the test fails, see “[Understanding the HDCP test](#)” on page 387.

6. To test another device, connect the cable to the new device.

The HDCP test starts automatically.

Running HDCP test in step mode

The 882 normally runs the steps in the HDCP test automatically. However, to troubleshoot a failed test, you can run the test in “step” mode. This enables you to read the values at the step where the test failed.

To run the HDCP test in step mode:

1. Connect a cable between the HDMI OUT connector on the 882 and the device’s input.
2. Activate the HDMI-H or HDMI-D interface on the output port as follows:
 - a. Press the **Interface** key. A listing of signal interfaces appears on the 882’s display as shown below (HDMI shown in the example only).

* VGA	CVBS
HDMI-D	S-VIDEO
HDMI-H	SDI

- b. Choose either the **HDMI-H** or **HDMI-D** item by pressing the adjacent soft key. The interface is activated, and the port outputs the currently selected image and format.

Alternatively, to activate the interface through the command line interface, enter the following commands:

```
XVSI 4 // Activates the HDMI-H interface (3 for HDMI-D)
ALLU // Applies the interface setting to the 882
```

3. Press the **Content** key and choose the **HdcpProd** image by pressing the adjacent soft key. Or, if you are using HDMI OUT port 2, choose the **HDCP2** test image.
4. Enable and view image versions for the test image as follows:

- a. Press the **Options** key. The following menu appears on the 882’s display:

-More	Red+
-NoGamma	Green+
-Noise	Blue+

- b. Choose the **More** item by pressing the adjacent soft key until a + and Rendition appears next to the item.

+More	Rendition: 000
	Red+
-NoGamma	Green+
-Noise	Blue+

- c. Press the + key to advance through the image versions.

Alternatively, to enable and view image versions using the command line interface, enter the following commands:

```
ISUB 1      // Enables sub images
IVER 1      // Specifies the first image version
IMGU       // Activates the image version
```

5. When you are finished, disable image versions by pressing the **Options** key and choosing **More** until a - appears next to it.

Alternatively, to disable image versions using the command line interface, enter the following command:

```
ISUB 0      // Disables sub images
```

Running an HDMI HDCP self-test

An HDCP self-test checks that HDCP authentication is working properly between the transmitter and receiver on the analyzer. This test can also be used to confirm that a cable is not interfering with HDCP authentication, and that the DDC clock and DDC data pins (used by the I2C bus) are working correctly.

To run an HDCP self-test:

1. Connect the HDMI cable between the HDMI IN and HDMI OUT connectors on the 882.
2. Activate the HDMI-H interface on the output port as follows:
 - a. Press the **Interface** key. A listing of signal interfaces appears on the 882's display as shown below.

* VGA	CVBS
HDMI-D	S-VIDEO
HDMI-H	SDI

- b. Choose **HDMI-H** item by pressing the adjacent soft key. The interface is activated, and the port outputs the currently selected image and format.

Alternatively, to activate the interface through the command line interface, enter the following commands:

```
XVSI 3 // Selects the HDMI-H interface
ALLU // Applies the interface setting to the 882
```

3. Enter the following command to initiate and run the test with any image displayed. A zero is returned if the HDCP test is successful.

```
HDCP? (OUT1:HDCP?, OUT2:HDCP?)
```

You can also specify a number of frames to run the test for. For example to run the test for 2000 frames you would enter:

```
HDCP? (OUT1:HDCP?, OUT2:HDCP?)
```

Understanding the HDCP test

Understanding what the 882 does during an HDCP test can help you determine why an HDCP test failed.

HDMI HDCP test sequence:

The HDMI HDCP test sequence performed by the 882 is listed below.

1. Reset the transmitter HDCP engine.
2. Initialize the transmitter.
3. Check Bcaps over the DDC bus to determine if the sink is a receiver or a repeater and generate a new An value (8 byte random session number) in the transmitter.
4. Transmitter writes An to the receiver using the DDC bus.
5. Transmitter writes Aksv to the receiver using the DDC bus.
6. Read Bksv from the receiver over the DDC bus and validate that it has exactly 20 zeroes and 20 ones in it. You can query this value with the following command:

```
i2cr? hdl 74 0 5  
I2CR? (OUT1:I2CR?, OUT2:I2CR?, VGA:I2CR?)
```

The display may return a value such as the following which is:

```
07BE05CEA9
```

The value in binary is 0000011110111110000001011100111010101001 which contains 20 zeros and 20 ones.

7. Write the Bksv value to the transmitter to trigger calculation of R0.
8. Wait for the R0 calculation in the transmitter to complete.
9. Wait for at least 100 milliseconds and then read the R0' value out of the receiver over the DDC bus and compare the value with the R0 calculation in the transmitter. If this step fails, then go to step 1.
10. Enable encryption and read Ri' from the receiver over the DDC bus every 128 frames and compare it to the Ri value calculated in the transmitter. As long as the Ri value matches the Ri' value from the receiver continue to check these every 128 frames.

13 Using Special Sync Output

Topics in this chapter:

- [Overview](#)
- [Operating special sync for probe pulse](#)
- [Configuring special sync for FS, LS, or CS](#)

Overview

The generator is equipped with a Special Sync BNC connector on the rear of the generator labeled SPECIAL. You can configure the output of this video interface to output frame sync, line sync, composite sync or a special probe pulse.

The probe feature is used with a programmable probe pulse that is available on the Special Sync BNC connector. This pulse is most often used to trigger an oscilloscope or synchronize an inspection camera. The probe feature allows you to position the leading edge of the probe pulse anywhere within the video frame. This feature greatly facilitates troubleshooting by enabling you to focus on specific video signal problems occurring anywhere in the video signal.

Operating special sync for probe pulse

Configuring the probe feature involves positioning the probe pulse in the desired location on the video frame. You can do this using either the generator front panel or the command line interface. The front panel is most convenient if you are near the generator and not using a computer or terminal. Alternatively, you can control the generator through the command line interface either locally or remotely through the serial connection or through a Telnet session.

Probe coordinate numbering

Unlike ITU and SMPTE standards, the Quantum Data standard counts pixels, lines, and coordinates beginning with the number zero (not one) to improve the mapping between video signal specifications and modern computer graphics coordinates. The television standards are accounted for by suppressing any half-active line that appears in an equalizing interval and lengthening (to a full line) any half-active line that begins in the active portion of a field. Vertical counting always begins with the leading edge of blanking of the first field (not vertical sync). The first field is always defined as the field that includes the top line of the displayed picture (Y:0). This definition is always true whether the total number of active lines is odd or even.

With interlaced scanning, lines continue to be numbered sequentially throughout the frame, beginning with the leading edge of blanking of the first field. Therefore, the first two lines of blanking in the first field are numbered L:0 followed by L:1. If you have 525 total lines and 486 of those are active, for example, the first two (blank) lines of the second field would be numbered L:262 and L:263. The Y position continues to follow the visual order of lines going from the top to the bottom of the screen. If the last line of blanking in the first field is L:18, then L:19 corresponds to Y:0, L:20 to Y:2, L:21 to Y:4 and so on. In the second field, L:282 would correspond to Y:1, L:283 to Y:3, L:284 to Y:5 and so on.

Configuring the probe feature

This section describes how to configure the probe feature. Configuring the probe feature entails enabling the probe, configuring the sensitivity for traveling through the frame, and identifying the line(s) on which the probe is present.

To configure the probe feature:

1. Press the **Tools** key. The following menu appears on the generator's display:

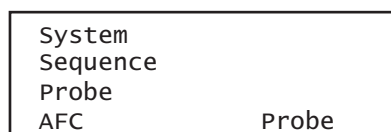

- Choose the **Probe** item by pressing the adjacent soft key. The current probe settings appear on the generator's display as shown below:

Left	P:0000	Exp
Right	X:0000	1
Up	L:0000	10
Down	Y:0000	100

- Press the **Settings** key to access the setting for the probe pulse width. The following appears on the generator's display:

Probe Tool	
Probe width	
PSPW	
<-	136

- Set the probe width as follows
 - Position the blinking cursor on the digit you want to change. To do this, press the soft key adjacent to the arrow by the width value to move the cursor left or right until it appears on the digit you want to change.
 - Adjust the value of the digit up or down by pressing the + or - keys. Repeat for each you want to change.
- To save the changes, press the **Enter (Options)** key. The following choices appear on the generator's display:

Apply Settings?	
Yes	Back
	No

To save the changes, choose the **Yes** item by pressing the adjacent soft key.

To exit without saving the changes, choose the **No** item.

To return to the previous screen without saving the changes, choose the **Back** item.

- Press the **Options** key. The options for setting the line or lines on which the probe pulse will occur appears on the generator's display:

*OneLine	Exit
AllActive	
AllLines	
	visible-

- Press the soft key adjacent to the desired option, as follows:
 - OneLine: Probe pulse occurs once per frame.
 - AllActive: Probe pulse occurs on every active line in the frame.
 - AllLines: Probe pulse occurs on every line in the frame.

8. Enable or disable the visibility setting by pressing the soft key adjacent to the Visible item on the display. A + indicates visibility is enabled; a - indicates it is disabled. Enabling the visibility setting will allow you to see the pulse position on a monitor.

To position the probe pulse in a specific location in the video signal:

1. Press the **Tools** key. The following menu appears on the generator's display:

System	
Sequence	
Probe	
AFC	Probe

2. Choose the **Pulse** item by pressing the adjacent soft key. The current probe settings appear on the generator's display as shown below:

Left	P:0000	Exp
Right	X:0000	1
Up	L:0000	10
Down	Y:0000	100

3. Select the travel sensitivity of the positioning keys by pressing the soft key adjacent to the desired setting. Refer to the table below.

Setting	Sensitivity
EXP	exponential increase/decrease when +/- keys are pressed
1	increase/decrease by 1 line or pixel when +/- keys are pressed
10	increase/decrease by 10 lines or pixels when +/- keys are pressed
100	increase/decrease by 100 lines or pixels when +/- keys are pressed

4. Set the horizontal position of the probe pulse by pressing the soft key adjacent to the Left or Right item on the generator's display.

The horizontal position of the probe is simultaneously displayed in two different ways:

- The horizontal position $P:nnn$ is given in pixels relative to the leading edge of the horizontal sync.
- If the leading edge of the probe is within the active portion of a line, an alternate horizontal position $X:nnn$ is also displayed, indicating the number of pixels between the start of active video ($X:0$) and the leading edge of the probe pulse in the horizontal direction.

5. Set the vertical position of the probe pulse by pressing the soft key adjacent to the Up or Down item on the generator's display.

The vertical position of the probe is simultaneously displayed in two different ways:

- The vertical position $L:nnn$ is given in whole scan lines relative to the leading edge of blanking of the frame or first field.

- If the probe is within the active portion of the frame, an alternate vertical position *Y:nnnn* is also displayed, indicating the number of lines between the start of active (Y:0) and the leading edge of the probe in the vertical direction.

Controlling the probe using the command line interface

Using the command line interface to control the probe provides more control, enables you to change the polarity and width, and to change the format and image while maintaining the probe pulse parameters.

To configure the probe feature:

1. Establish a session with the generator using either HyperTerminal over a serial connection or Telnet over an Ethernet LAN. See “[Establishing a terminal session with the 882](#)” on page 30 or “[Establishing a Telnet session with the 882](#)” on page 33.
2. Enable the probe feature by entering the following commands:

```
FSPG 0 // disable the frame sync on special sync output
PSPG 1 // enable the probe pulse
PSPP 1 // set the probe pulse polarity (0 for low or 1 for high)
PSPW 10 // set pulse width to 10 pixels (range: 1 pixel to HTOT - 1)
PSHD 100 // set pulse horizontal position at 100 pixels from leading
// edge of horizontal sync pulse, in range from 0 <=
// PSHD < (HTOT - PSPW - 1)
PSVW 50 // set the pulse vertical position at 50 lines from leading
// edge of vertical blanking, in range from 0 <=
// PSVD < (VTOT-1)
ALLU // apply the settings
```

To set the lines on which the probe pulse occurs:

1. Enter the appropriate command:

Set the probe pulse to occur	Command
Once per frame	<code>PSPM 0</code>
Once every active line	<code>PSPM 1</code>
Once every line	<code>PSPM 3</code>

2. Send the `ALLU` command to apply the setting.

Configuring special sync for FS, LS, or CS

The special sync output can provide frame sync, line sync, or composite sync signals. The output is controlled by setting parameters of these signals using the command line interface. The following commands are used to set the special sync signal:

- **FSPG** - Frame sync
- **PSPG** - Probe signal
- **LSPG** - Line sync
- **CSPG** - Composite sync

Note: The special sync output is disabled whenever these parameters are set to zero.

A frame pulse can be generated and output at the beginning of each frame. In the case of interlaced video, the frame pulse is output at the beginning of the blanking interval (of the first field) that immediately precedes the top line of active video.

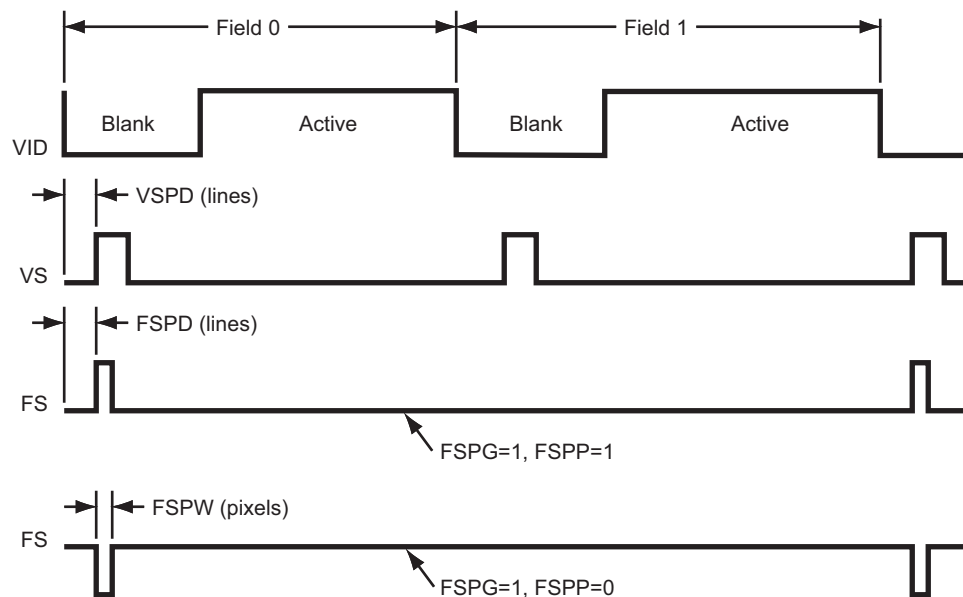

To configure frame sync on the special sync output:

1. Establish a session with the generator using either HyperTerminal over a serial connection or Telnet over an Ethernet LAN. See [“Establishing a terminal session with the 882”](#) on page 30 or [“Establishing a Telnet session with the 882”](#) on page 33.
2. Enable the frame sync by entering the following command:

```
FSPG 1
```

The values of the other parameters (**LS?** and **CSPG**) do not matter once FSPG is enabled.

3. Set the frame pulse polarity (either 0 for low or 1 for high) by entering the following command:

```
FSPF 1
```

4. Set the frame pulse pixel width by entering the following command:

```
FSPW 100 // range: 1 pixel to HTOT - 1
```

5. Set the frame pulse delay by entering the following command:

```
FSPD 10 // range: 0 <= FSPD < (VTOT - FSPW - 1); default = 0
```

6. Save these settings by entering the following command:

```
ALLU
```

To configure line sync on the special sync output:

1. Enable the line sync signal by entering the following commands:

```
FSPG 0  
PSPG 0  
LSPG 1  
ALLU
```

The value of composite sync (**CSPG**) does not matter once these are set.

2. Set the line sync pulse polarity by entering the following command:

```
LSPF 1 // 1 = high (default)  
ALLU
```

To configure composite sync on the special sync output:

1. Enable digital composite sync by entering the following command:

```
SSST 2 // (or 6,11)
```

2. Enable the composite sync signal by entering the following commands:

```
FSPG 0  
PSPG 0  
LSPG 0  
CSPG 1  
ALLU
```

3. Set the composite sync pulse polarity by entering the following commands:

```
CSPF 1 // 1 = high (default)  
ALLU
```

14 Script SDK

Topics in this chapter:

- [Overview](#)
- [Creating executable program scripts](#)
- [ScriptSDK API functions by category](#)
- [ScriptSDK API functions by name](#)
- [ScriptSDK commands](#)
- [Sample ScriptSDK programs](#)

Overview

The Quantum Data Software Development Kit (SDK) provides Application Programming Interfaces (APIs) for two categories of automation: 1) custom images (Image SDK) and 2) executable scripts (ScriptSDK). Both of these SDKs use the C++ programming language.

The Script SDK API provides a programming interface for executing any set of commands in the 880 series command language. Additional functions allow for program control, user input/output, and debugging. ScriptSDK is a much more powerful alternative to the test sequence feature in the 881/882 generators. By providing full access to the 880 series command language, ScriptSDK allows for a broad range of control and functionality in executable scripts that reside within the generator. The executable program scripts can be executed via the ScriptSDK selection in the 882's TOOLS menu.

The entire ScriptSDK system includes components that reside on the personal computer (PC) and components that reside in the Quantum Data 881/882 generator. The PC components include:

- C++ compiler
- Libraries
- Header files
- Examples
- Templates
- Graphical User Interface

These are automatically downloaded from the Quantum Data website and installed on the PC the first time the Quantum Data SDK is run. The graphical user interface (GUI) program includes the text editor and menus to compile programs and load the executable object files into the generator. The GUI is a Java application that is loaded from the 881/882 generator each time the Quantum Data SDK is run.

The other components of this system lie within the embedded firmware in the Quantum Data 881/882 generator. This includes the Scriptrunner functionality for running the executable program scripts, as well as the proper linkages to allow the custom images to load.

Installation

The Quantum Data SDK can be accessed from the generator's home page beginning with firmware version 2.18.0. It is implemented as a Java application, and the Java Runtime Environment (JRE) is required on the host computer. JRE version 5 is recommended.

The SDK is launched from the Quantum Data SDK list item on the generator's home page. If the SDK is not yet installed, the user will be prompted through the installation process which includes connecting to the Quantum Data website. Therefore, an internet connection is required. If the older command-line version of the Image SDK is already installed on the system, it will be replaced by the Quantum Data SDK. The installation program can save the original SDK on the computer.

For first-time installation, an internet connection is required so that the automatic installation process can retrieve the installation package from the Quantum Data website. If the host computer does not yet have JRE, it can be downloaded from the java.com website, or via a link near the bottom of the generator's home page.

Image programs versus script programs

When the Quantum Data SDK is launched, the user has a choice of Image SDK or ScriptSDK, depending on the type of application to be developed. When the SDK is running, the user can freely switch between Image SDK and Script SDK at any time.

The Image SDK is used to create resolution-independent test patterns and other display images. When an image is loaded from the SDK into the generator via the Load & Execute menu selection, it is displayed immediately. An image load consists of a file transfer and the commands IMG P, IMG L, and IMG U. After loading the image via the SDK, the image is then available to be selected for display via browse mode.

The ScriptSDK is used to create executable programs that can be stored in the generator and run from the SDK menu. A ScriptSDK program can contain any commands in the 880 command language, as well as user menus, responses to key presses, numeric input, and output to the serial port.

Creating executable program scripts

This sections provides information and procedures for using the ScriptSDK application.

Getting Started

The following are the important points to keep in mind when creating executable scripts:

- Naming files
- Return values on exit
- Enabling output
- Softkey functions

These are described in the following subsections.

Naming the file and the executable script

The executable script will have the same base name as the source file. This name must be lower-case, and it should be 8 characters or less in length. This name must be appended to "Script_" to name the function.

For example, for an executable script called "demo" the source file will be demo.cpp. The main function will be Script_demo(), and the resulting object file will be demo.o. The "load & execute" command will send this object file to the generator, and it will be visible in the Scripts menu as "demo."

Returning “true” on exit

The script's main function (e.g., Script_demo()) must return "true" on exit. As in any C or C++ program, it is okay to have multiple return points. Refer to the sample programs for examples.

Enabling output to a serial terminal

By executing the CIOY command `sc.Exec("CIOY");` you can enable output to the serial terminal for debugging and/or status output via `printf()`. You can connect a simple serial terminal (such as Hyperterm running on a PC). Serial port settings default to 9600 baud, 8 bits, no parity, 1 stop bit, no handshake. The required DB-9 null cable is included with all 880 series generators.

Writing to a log file

In some applications you may wish to write data out to a text file for later examination. For example you may want to create a script that measures the timing parameters of an incoming HDMI signal and write them out to a file. Starting in Release 2.19 you can do this. You will need to include three extern declarations at the top of the script:

```
extern int fopen();  
extern int fclose();  
extern int fprintf();
```

You will also need to include a File* declaration which points to a path where the log file is stored. Examples are shown in this chapter.

Halting a script through the front panel during execution

When a script is executing, the top right soft key on the 882 is assigned to the STOP function. If the STOP key is pressed, the `sc.Canceled()` method will return true. The script must check this state in order to detect whether the STOP key has been pressed. A script should always return true when exiting. See example programs `testapi.cpp` and `tcan.cpp`.

Some scripts may take over the top right soft key so it is not available for the STOP function. The example program `testapi` is an example of this. Therefore, the generator's OPTIONS key is always available to interrupt scripts that are running. After pressing the OPTIONS key, pressing the bottom left soft key (!Yes) will stop the script.

About the ScriptSDK main window

The Quantum Data SDK GUI is shown below. It is centered around the text editor. The title bar at the top indicates whether the program is currently set for ScriptSDK or ImageSDK. Beneath the title bar is the menu bar, featuring pull-down menu categories of File, Compile, Load&Execute, and Connection. The menu bar also contains a button for toggling between ScriptSDK and ImageSDK modes.

Under the menu bar is the main section of the GUI, the tabbed Editor pane. Multiple files can be edited, and each file has its own tab. Under the Editor pane is the output pane. The two tabs in this pane contain compiler output and connection output. Finally, the status bar at the bottom of the window shows the IP address of the 880 series generator that is currently connected.

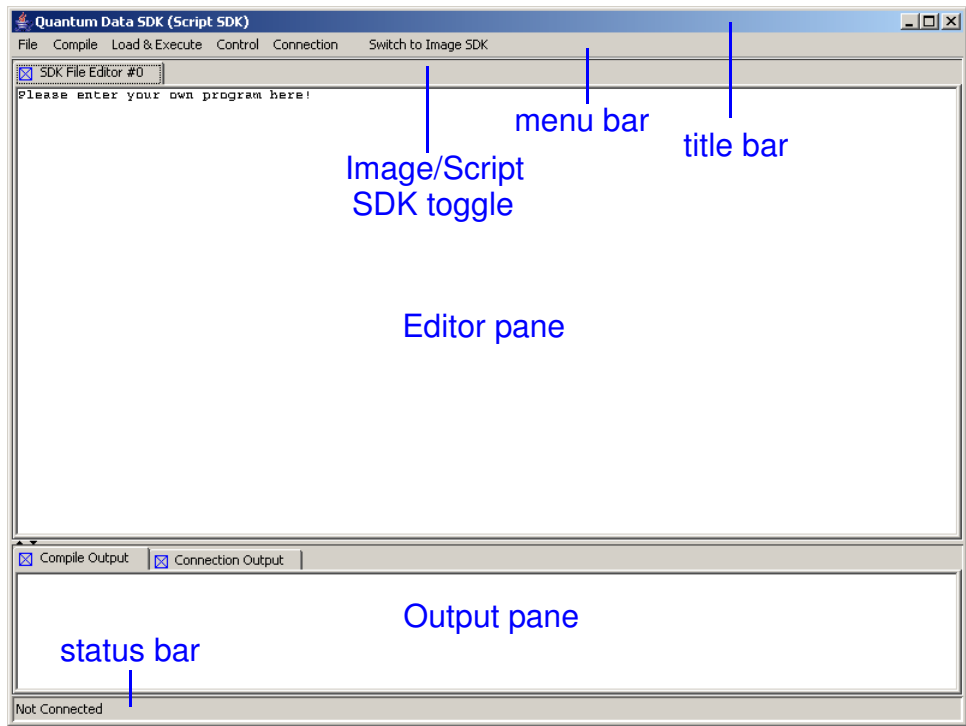

ScriptSDK menu summary

Refer to the table below for a list of menu commands.

Menu	Command	Description
File	New	Opens a new empty file in the tabbed editor pane.
	New File from Template	Only active in ScriptSDK mode, this selection presents a dialog for opening a template file from the script_templates folder.
	Open	Presents a dialog for opening an existing source file. In ScriptSDK mode the default folder is scripts; in ImageSDK mode the default folder is examples.
	Close File	Closes the file in the current editor tab.
	Save	Saves the file in the current editor tab.

Menu	Command	Description
	Save as	Presents a dialog for saving the current file, allowing the user to choose a new filename and/or folder.
	Preference	Allows the user to choose between the Quantum Data SDK text editor and another text editor on the host PC
	Exit	Exits the Quantum Data SDK. This will also cause the web browser to immediately terminate, so it is recommended to instead use the web browser's back button to exit the SDK.
Compile	Current File	Compiles the file in the current editor tab.
	Another File	Presents a dialog for choosing a source file to compile.
Load& Execute	Object File	Presents a dialog for choosing the object file to load to the generator.
Control	Pause	
	Terminate	
Connection	Connect to	Presents a dialog for entering the IP address of the generator to connect to. The dialog defaults to the generator that the application was launched from.
Switch to Image SDK		Allows the user to toggle between ImageSDK and ScriptSDK. This switch changes the default folders on the host PC for source and object files; it also changes the destination path on the generator for storing executable object files.

Starting ScriptSDK

To start ScriptSDK:

1. Connect to the generator through your Web browser. The generator Home page appears.

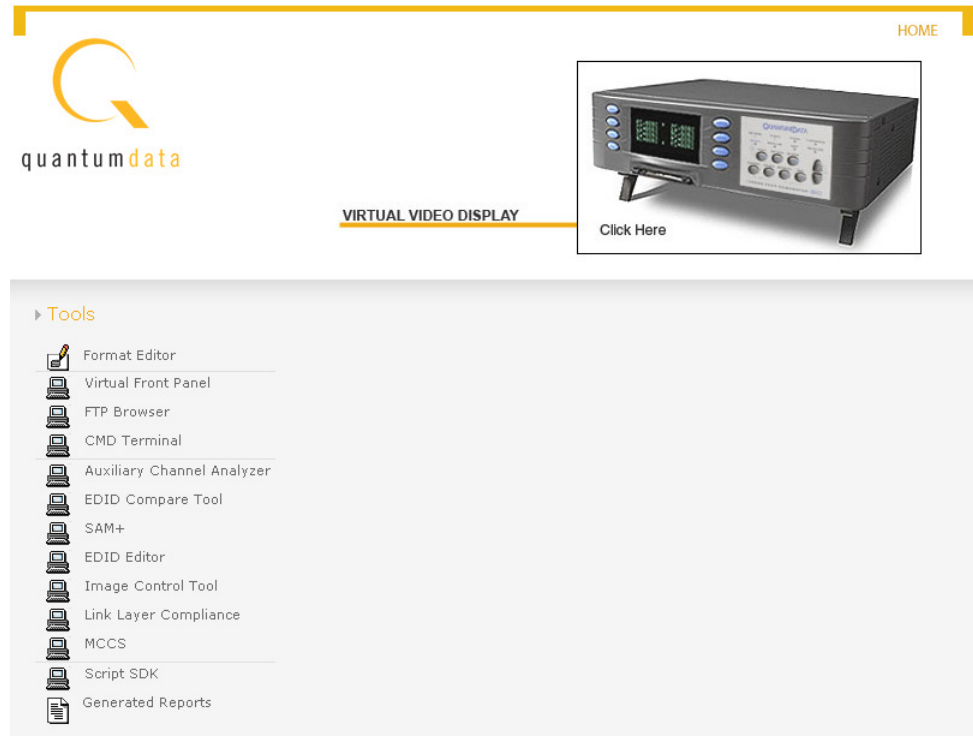

2. On the generator Home page, click **Script SDK**. The ScriptSDK Home page appears, and then a message appears asking you to choose whether you want to connect to ScriptSDK or ImageSDK.

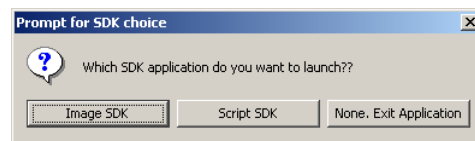

3. Click **Script SDK**. The ScriptSDK main window appears as shown below.

Creating, compiling, and executing a script

To start a scripting session:

1. With the ScriptSDK main window open, click **Connection**, and then click **Connect to**. The Input dialog box appears.

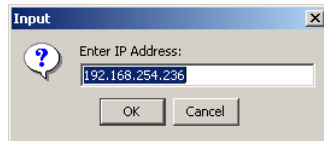

2. Enter the IP address of the generator you want to connect to. (The default address is the address of the generator from which you launched ScriptSDK.) Click **OK**. ScriptSDK attempts to connect to the generator and displays the message **Successfully Connected to Unit** when connected. Click **OK**.

To open an existing script:

1. Click **File**, and then click **Open**. The Open Script dialog box appears.

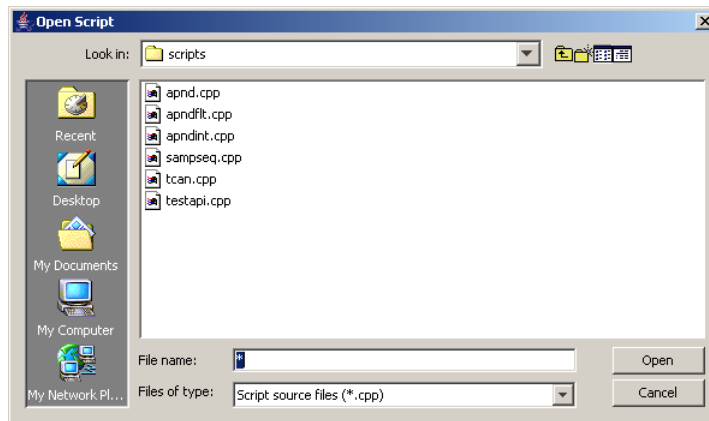

2. Select the script you want to open, and then click **Open**. The script appears in the Editor pane. You can have multiple scripts open at the same time. Each script appears as a separate tab in the Editor pane.

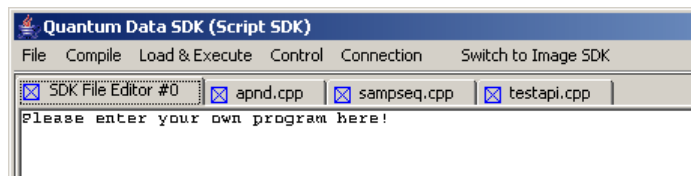

To create a new script:

1. Click **File**, and then click **New**. A new tab appears in the Editor pane.

2. Type the script in the Editor pane.

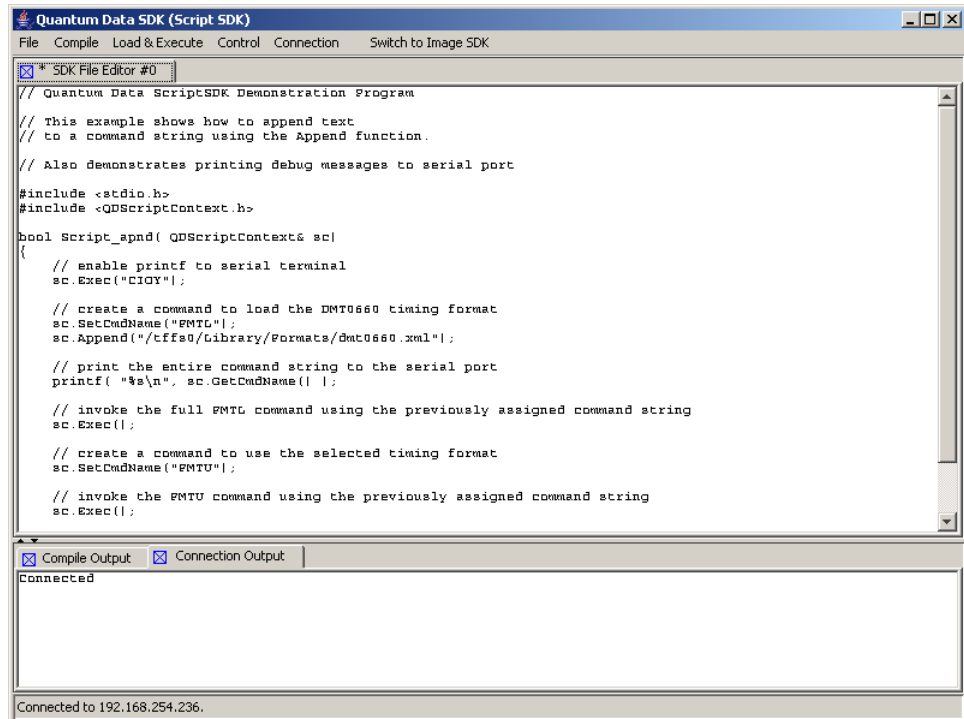

3. When you are finished, click **File**, and then click **Save**. The Save Script dialog box appears. In the **Filename** box, type a name for the script, and then click **Save**.

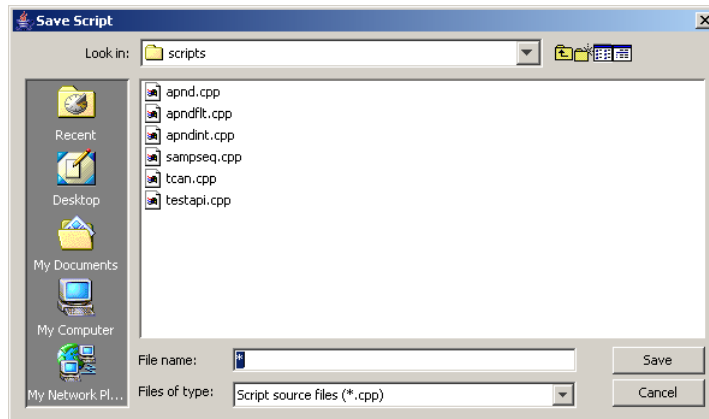

To create a new script using a template:

1. Click **File**, and then click **New File from Template**. The Select Template dialog box appears.
2. Select the template you want to use, and then click **Open**. The template appears in the Editor pane.

3. Modify the template as needed to match your requirements. When you are finished, click **File**, and then click **Save**. The Save Script dialog box appears. In the **Filename** box, type a name for the script, and then click **Save**.

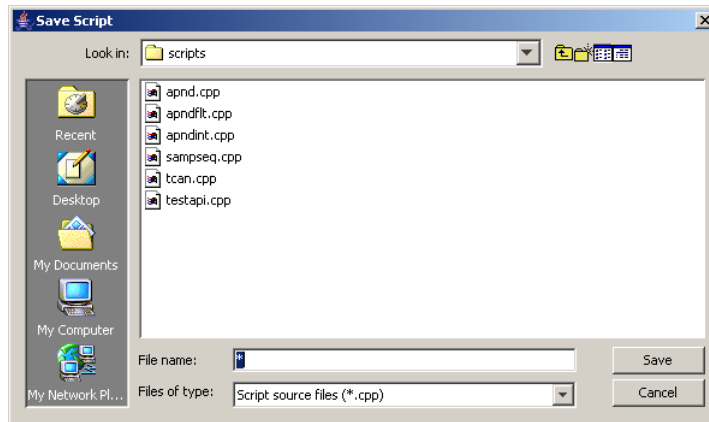

To compile a script:

1. To compile a script, click the tab in the Editor Pane that contains the script you want to compile.
2. Click **Current File** from the Compile pull down menu. The file is compiled and any compiler messages appear in the Compile Output pane. The output of the compile process is an executable object file that is placed in Scripts folder, which is in the SDK folder on your 882 generator library directory.

To execute a script from the ScriptSDK GUI:

1. Click **Object File** from the **Load&Execute** pull down menu. A dialog box called Choose Object File dialog box appears.
2. Select the file you want to execute, and then click **Choose**. A message appears telling you if the execution was successful.
3. You can also execute a scrip

To execute a script from the 882 front panel:

1. Press the **Tools** key. The Tools menu appears on the generator's display as shown below.

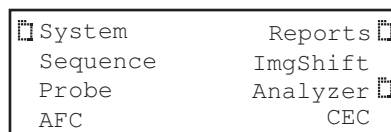

2. Scroll down until you see the ScriptSDK selection item.

The list of available scripts is presented.

Sampseq1	Sampseq2
Sampseq3	Sampseq4

3. Execute the desired script by pressing the adjacent soft key.

The script that has been selected and is now running is shown along with an option to stop the script.

*Sampseq1	stop
-----------	------

To execute a script from the 882 command line:

1. Load the script file that you want to execute by entering the following command.

```
SCRX:LOAD testapi.o //loads script object from current scripts path
```

For a list of scripts, enter the following command:

```
SCRX:LIST?
```

2. Execute the script by entering the following command:

```
SCRX:EXEC // executes currently loaded script
```

To stop a script that is executing enter the following:

```
SCRX:STOP // stops execution of currently running script
```

ScriptSDK API functions by category

The ScriptSDK API functions are all public methods of the QDScriptContext class. They are presented in categories of control, command, response, front panel display, and operators.

Control functions

Command	Description
GetGC	Get the handle of TGC
Canceled	Status of script cancel
Pause	Calibrate generator (using self-calibration circuitry)

Command functions

Command	Description
SetCmdName	Set name of command to execute
GetCmdName	Get name of command to execute
Exec	Execute current command
Append	Append to command string
Reset	Reset the command string
SetDefaultTimeOut	Set default command timeout
GetDefaultTimeOut	Get default command timeout
SetCancelOnError	Set "cancel on error" status
GetCancelOnError	Get "cancel on error" status

Response functions

Command	Description
GetResponse	Get most recent response string
GetIntResponse	Get response as signed int
GetUIntResponse	Get response as unsigned int
GetDoubleResponse	Get response as double
GetRespLineCount	Get number of lines in response
ClearResponse	Reset the response
Failed	Get fail state of most recent command
Succeed	Get response state of most recent command
GetError	Get error value for failed command

Front panel functions

Command	Description
Write	Write a string to front panel display
InputInteger	Get integer user input via front panel
InputFloat	Get float user input via front panel
WaitForKeyPress	Wait for user to press a soft key
ClearLCD	Clear the front panel display

Operator functions

Command	Description
=	Assign name of command to be executed
+=	Append to command to be executed

ScriptSDK API functions by name

This subsection lists the ScriptSDK functions by name and provides details about how to use them.

Append

Class	Command
Description	Adds characters to an existing command string, created with a call to <code>SetCmdName()</code> . Allowable arguments are char pointer, integer, and double-precision float. In the case of an integer argument, the radix for the base of the resulting string can be specified optionally. The default radix is 10.
Command syntax	<code>sc.Append(const char* txt)</code> <code>sc.Append(UINT32 value, UINT32 RADIX=10)</code> <code>sc.Append(double value)</code>
Example	Refer to example programs <code>apndflt.cpp</code> , <code>apndint.cpp</code> , <code>sampseq.cpp</code> , <code>testapi.cpp</code>
Related commands	<code>Exec()</code> , <code>GetCmdName()</code> , <code>Reset()</code> , <code>SetCmdName</code> ,

Canceled

Class Control

Description Returns script cancel state. A script can be set to cancel state by pressing the STOP (upper right) soft key during execution, or by pressing the OPTIONS key and then the lower-left (!Yes) soft key to confirm. A script can also be set to cancel state if its CancelOnError status is true, and the script encounters an error while executing. To cancel script execution, the script must check the return value of Canceled(); if it is true, the script should immediately return a value of true.

Command syntax sc.Canceled(void)

Example Refer to example programs apndflt.cpp, apndint.cpp, sampseq.cpp, tcan.cpp, testapi.cpp

Related commands Exec(), GetCmdName(), Reset(), SetCmdName

ClearLCD

Class Front Panel

Description Clears the entire display on the front panel of the generator

Command syntax `sc.ClearLCD(void)`

Example Refer to example program `testapi.cpp`

Related commands `Write()`, `InputInteger()`, `InputFloat()`

ClearReponse

Class Response

Description Resets the command response string to a default empty state. This can be used to clear a response after it is queried; therefore the next non-empty response will be a new response.

Command syntax `sc.ClearResponse(void)`

Related commands `GetResponse()`, `GetIntResponse()`, `GetUIntResponse()`, `GetDoubleResponse()`

Exec

Class	Command
Description	Execute a command. Command can be pre-built using SetCmdName() and Append(), or a pointer to a command string can be passed. Command timeout in milliseconds can be specified optionally.
Command syntax	sc.Exec(void) sc.Exec(UINT32 timeout) sc.Exec(char* cmdString) sc.Exec(char* cmdString, UINT32 timeout)
Return type	UNIT32
Example	Refer to sample programs apnd.cpp, apndflt.cpp, apndint.cpp, sampseq.cpp, tcan.cpp, testapi.cpp
Related commands	SetCmdName(), Append(), GetCmdName(), SetDefaultTimeOut(), GetDefaultTimeOut(), Command Reference in Appendix A of 881/882 Series User Guide

Failed

Class	Response
Description	Returns true if previous command execution failed.
Command syntax	sc.Failed(void)
Return type	bool
Related commands	Exec(), Succeed(), GetError()

GetBoolResponse

Class Response

Description Gets the most recent query response string and returns it as a bool. If the first character of the response string is "T" or "t" the return value is "true." If the first character of the response string is "F" or "f" the return value is "false." Otherwise, it will attempt to convert the string to unsigned long via strtoul(). If the result of the conversion is zero, the return value is "false." If the result is not zero, the return value is "true."

Command syntax sc.GetBoolResponse(void)

Return type bool

Example Refer to sample program testapi.cpp

Related commands GetResponse(), GetIntResponse(), GetUIntResponse(), GetDoubleResponse(), GetRespLineCount(), ClearResponse()

GetCancelOnError

Class Command

Description Returns CancelOnError status. Return value of true indicates that an execution error will cause Canceled() to be true. To terminate script execution on error, program code should check the state of Canceled(); if it is true the program should exit via "return true;"

Command syntax `sc.GetCancelOnError(void)`

Return type `bool`

Related commands `Canceled()`, `SetCancelOnError()`, `GetError()`

GetCmdName

Class Command

Description Returns the current contents of the command string. The command string can be built using SetCmdName(), Append(), =, and +=.

Command syntax sc.GetCmdName(void)

Return type const char*

Example Refer to sample programs apnd.cpp, apndflt.cpp, testapi.cpp

Related commands SetCmdName(), Exec(), Append(), operator =, operator +=

GetDefaultTimeOut

Class Command

Description Returns the current timeout value for commands, in milliseconds.

Command syntax `sc.GetDefaultTimeOut(void)`

Return type UNIT32

Related commands SetDefaultTimeOut()

GetDoubleResponse

Class Response

Description Gets the most recent query response string and returns it as a double-precision floating point value.

Command syntax `sc.GetDoubleResponse(void)`

Return type double

Example refer to sample program `testapi.cpp`

Related commands `GetResponse()`, `GetIntResponse()`, `GetUIntResponse()`, `ClearResponse()`

GetError

Class Response

Description Returns the error value of the previous command.

Command syntax `sc.GetError(void)`

Return type `UNIT32`

Example refer to sample program `testapi.cpp`

Related commands `Exec()`, `Failed()`, `Succeed()`

GetGC

Class Control

Description Returns a pointer to an instance of the graphics core object that provides dynamic linking with internal generator firmware.

Command syntax GetGC(void)

Return type TGC*

GetIntResponse

Class Response

Description Gets the most recent query response string and returns it as a signed 32-bit integer value.

Command syntax `sc.GetIntResponse(void)`

Return type INT32

Example refer to sample program `testapi.cpp`

Related commands `GetResponse()`, `GetUIntResponse()`, `GetDoubleResponse()`, `ClearResponse()`

GetRespLineCount

Class Response

Description Some query responses can consist of multiple lines of output. This method returns the number of lines of output from the most recent query.

Command syntax `sc.GetRespLineCount(void)`

Return type INT32

Example refer to sample program `testapi.cpp`

Related commands `GetResponse()`, `GetIntResponse()`, `GetUIntResponse()`, `GetDoubleResponse`, `ClearResponse()`

InputFloat

Class Front Panel

Description Presents a dialog for user input of a floating point value via front panel display and keys. Parameters allow specification of the displayed prompt, number of digits (whole and fractional,) and initial value. The prompt string is required. The whole and frac parameters are optional and both default to 4. The initValue parameter is optional and defaults to zero.

Command syntax `sc.InputFloat(const char*prompt, UINT32 whole, UINT32 frac, double initValue)`

Return type double

Example refer to example program testapi.cpp.

Related commands `InputInteger()`, `ClearLCD()`

InputInteger

Class Front Panel

Description Presents a dialog for user input of an integer value via front panel display and keys. Parameters allow specification of the displayed prompt, number of digits, and initial value. The prompt string is required. The numDigits parameter is optional and defaults to 4. The initValue parameter is optional and defaults to zero.

Command syntax `sc.InputInteger(const char* prompt, UINT32 numDigits, INT32 initValue)`

Return type INT32

Example refer to example program testapi.cpp.

Related commands `InutFloat()`, `ClearLCD()`

Pause

Class Control

Description Forces a delay in program execution, for specified number of milliseconds.

Command syntax `sc.Pause(UINT32 timeValue)`

Return type void

Example refer to example programs `apndfilt.cpp`, `apndint.cpp`, `sampseq.cpp`, `tcan.cpp`, `testapi.cpp`.

Reset

Class `Command`

Description Clears the command string; resets it to the default empty state.

Command syntax `sc.Reset(void)`

Return type `void`

Example refer to example program `testapi.cpp`.

Related commands `SetCmdName()`, `Append()`, `GetCmdName()`

SetCancelOnError

Class Command

Description Sets or clears the CancelOnError status. If set (with an argument of true) an error or failure will cause the Canceled() state to be set to true. To terminate script execution on error, program code should check the state of Canceled(); if it is true the program should exit via "return true;"

Command syntax `sc.SetCancelOnError(bool)`

Return type void

Example refer to example program testapi.cpp.

Related commands Canceled(), GetCancelOnError(), GetError()

SetCmdName

Class Command

Description Sets a command string to be executed later. The command string can be added to with Append(). The command can be executed with Exec().

Command syntax `sc.SetCmdName(const char*)`

Return type void

Example refer to example programs `apnd.cpp`, `apndflt.cpp`. `testapi.cpp`

Related commands refer to example programs `apnd.cpp`, `apndflt.cpp`. `testapi.cpp`

SetDefaultTimeOut

Class Command

Description Sets the current timeout value for commands, in milliseconds.

Command syntax `sc.SetDefaultTimeOut(UINT32)`

Return type void

Example `sc.SetDefaultTimeOut(5000); // commands will time out in 5 seconds`

Related commands `GetDefaultTimeOut()`

Succeed

Class Response

Description Returns true if previous command execution was successful.

Command syntax `sc.Succeed(void)`

Return type `bool`

Example refer to example program `testapi.cpp`.

Related commands `Exec()`, `Fail()`, `GetError()`

WaitForKeyPress

Class Front Panel

Description Delays program execution until a soft key is pressed. Optional argument indicates desired timeout in milliseconds. Void argument or zero will result in wait for ever. Returns a value representing the key pressed; one of the following:

QD_KEY_LEFT_1
QD_KEY_LEFT_2
QD_KEY_LEFT_3
QD_KEY_LEFT_4
QD_KEY_RIGHT_1
QD_KEY_RIGHT_2
QD_KEY_RIGHT_3
QD_KEY_RIGHT_4

Command syntax `sc.WaitForKeyPress(void)`
`sc.WaitForKeyPress(UINT32)`

Return type QDKeyld

Example refer to example program testapi.cpp.

Related commands `Write()`, `ClearLCD()`

Write

Class Front Panel

Description Write a string to the generator's front panel display. The display is 20 characters by 4 lines. Allowable values of column are in the range of 0 - 19. Allowable values of row are 0 - 3.

Command syntax `sc.Write(UINT32 column, UINT32 row, char* string)`

Return type `void`

Example refer to example programs `apndflt.cpp`, `testapi.cpp`

Related commands `ClearLCD()`, `WaitForKeyPress()`, `InputFloat()`, `InputInteger()`

Operator =

Class Operator

Description Assigns a string to the command string. The command string is represented by the pointer to the script context; sc. This is similar to SetCmdName().

Command syntax sc = "string"

Example sc = "SCRX:LOAD";// set the command string
also refer to example program testapi.cpp.

Related commands Operator +=, SetCmdName(), Append(), Exec()

Operator +=

Class Operator

Description Appends characters to the command string. The argument will be converted to ASCII character string if necessary. The command string is represented by a pointer to the script context; sc. This is similar to Append().

Command syntax sc += "string"
sc += char
sc += double
sc += UINT32

Example sc += "testapi.o";// append filename to the command string
also refer to example program testapi.cpp

Related commands Operator =, Append(), SetCmdName(), Exec()

ScriptSDK commands

This subsection lists the commands related to the ScriptSDK that can be executed through the 882's command line interface. These can be executed through the serial port, a telnet session or through the command utility available through the 882 home page.

SCRX:LIST?

Class Scriptrunner

Description Lists the executable script object files currently residing in the generator

Query syntax SCRX:LIST?

Query response list of executable script object files

Example `SCRX:LIST? // list executable scripts`

SCRX:PATH

Class	Scriptrunner
Description	Sets the current path for storage of SDK scripts. The query returns the current script path name.
Command syntax	SCRX:PATH < <i>name</i> > <i>name</i> a valid MS-DOS compatible path and filename (8 characters minus any extension)
Query syntax	SCRX:PATH? <i>name</i> returns a valid MS-DOS compatible path and filename for the name of the path
Query response	path name
Example	SCRX:PATH /tffs0/Library/Scripts // sets script path to default directory

SCRX:EXEC, SCRX:EXEC?

Class	Scriptrunner
Description	Executes the currently loaded script. The query returns the name of the currently executing script.
Command syntax	SCRX:EXEC
Query syntax	SCRX:EXEC?
Query response	path and name of currently executing script object file
Example	<code>SCRX:EXEC // execute currently loaded script</code>

SCRX:LOAD, SCRX:LOAD?

Class	Scriptrunner
Description	Loads a script object file in preparation for execution. Script object file must already be stored in generator file system. If the load command also includes a directory path, then this command will also change the current scripts path (SCRX:PATH) to the specified path. The query returns the name of the currently loaded script.
Command syntax	SCRX:LOAD < <i>name</i> > <i>name</i> a valid script file, including ".o" extension which can optionally include a fully-qualified path
Query syntax	SCRX:LOAD?
Query response	name of currently loaded script object file
Example	SCRX:LOAD testapi.o //loads script object from current scripts path SCRX:LOAD /tffs0/library/userdata/testapi.o //loads script object testapi.o from specified path, and also sets current script path to SCRX:LOAD? //returns name of currently loaded script object file

SCRX:KILL

Class	Scriptrunner
Description	Deletes an executable object file from the generator
Command syntax	SCRX:KILL name name a valid script file, including ".o" extension which can optionally include a fully-qualified path
Example	SCRX:KILL testapi.o // deletes script object testapi.o from current scripts path SCRX:KILL /tffs0/library/userdata/testing.o // deletes file testing.o from specified path

SCRX:STOP

Class Scriptrunner

Description Stops the execution of a script

Command syntax SCRX:STOP

Example `SCRX:STOP // stops execution of currently running script`

Sample ScriptSDK programs

This subsection provides some example ScriptSDK scripts to help you understand how to create scripts for specific applications.

apnd.cpp

This example shows how to append text to a command string using the Append function and demonstrates printing debug messages to a serial port.

```
#include <stdio.h>
#include <QDScriptContext.h>
bool Script_apnd( QDScriptContext& sc)
{
// enable printf to serial terminal
    sc.Exec("CIOY");
// create a command to load the DMT0660 timing format
    sc.SetCmdName("FMTL");
    sc.Append("/tffs0/Library/Formats/dmt0660.xml");
// print the entire command string to the serial port
    printf( "%s\n", sc.GetCmdName() );
// invoke the full FMTL command using the previously assigned command
string
    sc.Exec();
// create a command to use the selected timing format
    sc.SetCmdName("FMTU");
// invoke the FMTU command using the previously assigned command string
    sc.Exec();
return true;
}
```

apndflt.cpp

This example shows how to add a floating point numeric value to a command string using the Append function and also demonstrates writing to the 882 front panel display.

```
#include <stdio.h>
#include <QDScriptContext.h>
bool Script_apndflt( QDScriptContext& sc )
{
// For RGB: step the analog video signal swing from 0.1 volts
// to 1.0 volts in steps of 0.10 volts, pausing at each level
    double aswing;
// select a safe format, VGA
    sc.Exec("FMTL /tffs0/Library/Formats/DMT0660.xml");
// use this selected format
    sc.Exec ("FMTU");
// select a colorful image for this example
    sc.Exec("IMGL /Cache0/Images/colorbar.img");
// select RGB video out
    sc.Exec("XVSI 9");
// enable RGB video
    sc.Exec("AVST 2");
// apply the above image and interface selections
    sc.Exec("ALLU");
// step the analog video signal swing from 0.1 volts to 1.0
// volts in steps of 0.10 volts, pausing at each level
    for(aswing=0.10; aswing<1.01; aswing+=0.10)
    {
        // build the command to set analog video swing
        sc.SetCmdName("AVSS");
        sc.Append(aswing);
// write the command to the bottom of the front-panel display
        sc.Write( 0,3,(char *)sc.GetCmdName() );
// issue the command to set analog video swing
        sc.Exec();
// use the selected format parameters
        sc.Exec("FMTU");
// pause for 10 seconds at each level
        sc.Pause(10000);
// this will cause script to immediately exit if STOP is pressed
        if (sc.Canceled())
            return true;
    }
    return true;
}
```

apndflt.cpp

This example demonstrates appending an integer to a command string. This example will sequentially test 3 different video interfaces: HDMI, S-video, and composite.

```
#include <stdio.h>
#include <QDScriptContext.h>
bool Script_apndint( QDScriptContext& sc )

    UINT32 formatnum;

    sc.Exec("CIOY");          // enable printf to serial terminal

    // first load an image to use for this example:
    sc.Exec("IMGL /Cache0/Images/colorbar.img");
    // display the image
    sc.Exec("IMGU");

    // step through 3 interfaces: 4=HDMI-H, 5=SVideo, 6=CVBS
    for(formatnum=4; formatnum<=6; formatnum++)
    {
        // build command string to set video output interface
        // XVSI specifies which video output interface to use
        sc.SetCmdName("XVSI ");

        // use Append function to convert formatnum to character
        // and insert it into
        // command string. Base-10 conversion.
        // For this example, it will be either 4, 5, or 6.
        sc.Append(formatnum, 10);

        // print the entire command string to the serial port
        printf( "%s\n", sc.GetCmdName() );
        // execute the completed XVSI command
        sc.Exec();

        // This switch will select a video format that is appropriate
        // for the output interface selected above switch(formatnum)
        {
            case 4:
                printf("Now testing HDMI...\n");
                // load a format that is compatible with HDMI interface
                sc.SetCmdName("FMTL /tffs0/Library/Formats/dmt0660.xml");
                break;

            case 5:
                printf("Now testing SVideo...\n");
                // load a format that is compatible with SVideo interface
                sc.SetCmdName("FMTL /tffs0/Library/Formats/ntsc.xml");
                break;

            case 6:
                printf("Now testing CVBS...\n");
```

```
        // load a format that is compatible with CVBS interface
        sc.SetCmdName("FMTL /tffs0/Library/Formats/ntsc.xml");
    }
    // invoke the selected format
    sc.Exec();

    // use the format that was selected above
    sc.Exec("FMTU");

    // delay for 10 seconds on each interface
    sc.Pause(10000);

    // this will cause script to immediately exit if STOP is pressed
    if (sc.Canceled())
return true;
    }
    return true;
}
```

sampseq.cpp

```
// Quantum Data ScriptSDK Demonstration Program
```

```
//~~~~~
```

```
#include <stdio.h>
```

```
#include <QDScriptContext.h>
```

```
//~~~~~
```

```
/*~~~~~
```

```
* Script_sampseq
```

```
~~~~~
```

This is a conversion of "Sample Sequence" from chapter 8 of the 881/882 User Guide. This demonstrates how a sequence can be converted to an SDK script. Note that arguments are not always the same as in the sequence XML files, as shown in the XVSG conversions below.

In ScriptSDK, commands have the same syntax as if they were being entered at a command prompt. For full details on command syntax, refer to the Command Reference in Appendix A of the 881/882 User Guide available at: <http://www.quantumdata.com/downloads/index.asp>

Note: Note: this script (and the sequence that it evolved from) expects you to have previously selected a compatible interface, such as VGA or HDMI.

```
~~~~~
```

```
* Usage:
```

```
Script_sampleseq( QDScriptContext& sc );
```

```
*
```

```
* Arguments:
```

```
* sc - the script context being executed on.
```

```
~~~~~
```

```
bool Script_sampseq( QDScriptContext& sc )
```

```
{
```

```
//<?xml version="1.0" encoding="UTF-8" ?>
```

```
//<DATAOBJ>
```

```
    //<HEADER TYPE="SEQ" VERSION="1.0" ></HEADER>
```

```
    //<DATA>
```

```
    //<MODE>STEP</MODE>
```

```

//<STEP>
//<FMT>/tffs0/Library/Formats/DMT0660.xml</FMT>
sc.Exec("FMTL /tffs0/Library/Formats/DMT0660.xml");
sc.Exec("FMTU");
//<IMG>/Cache0/Images/Acer1.img</IMG>
sc.Exec("IMGL /Cache0/Images/Acer1.img");
sc.Exec("IMGU");
//<DELY>+3.0000000E+00</DELY>
sc.Pause(3000);
//<VERS>0</VERS>
sc.Exec("IVER 0");
//<XVSG>7</XVSG>
sc.SetCmdName("XVSG ");
sc.Append("1 1 1");
sc.Exec();

if (sc.Canceled()) {
    return true;
}
printf("Check Point 1\n");
//</STEP>
//<STEP>
//<IMG>/Cache0/Images/Cubes.img</IMG>
sc.Exec("IMGL /Cache0/Images/Cubes.img");
sc.Exec("IMGU");
//<DELY>+4.0000000E+00</DELY>
sc.Pause(4000);

if (sc.Canceled()) {
    return true;
}
printf("Check Point 2\n");

```

```

//</STEP>
//<STEP>
//<IMG>/Cache0/Images/Linearty.img</IMG>
sc.Exec("IMGL /Cache0/Images/Linearty.img");
sc.Exec("IMGU");
//<DELY>+5.5000000E+00</DELY>
sc.Pause(5500);

if (sc.Canceled()) {
    return true;
}
printf("Check Point 3\n");
//</STEP>
//<STEP>
//<FMT>/tffs0/Library/formats/DMT0860.xml</FMT>
sc.Exec("FMTL /tffs0/Library/Formats/DMT0860.xml");
sc.Exec("FMTU");
//<IMG>/Cache0/Images/RampX.img</IMG>
sc.Exec("IMGL /Cache0/Images/RampX.img");
sc.Exec("IMGU");
//<DELY>+3.0000000E+00</DELY>
sc.Pause(3000);

if (sc.Canceled()) {
    return true;
}
printf("Check Point 4\n");
//</STEP>
//<STEP>
//<XVSG>1</XVSG>
sc.Exec("XVSG 0 0 1");

```

```

//</STEP>
//<STEP>
//<XVSG>2</XVSG>
sc.Exec("XVSG 0 1 0");

//</STEP>
//<STEP>
//<XVSG>4</XVSG>
sc.Exec("XVSG 1 0 0");

//</STEP>
//<STEP>
//<XVSG>7</XVSG>
sc.Exec("XVSG 1 1 1");

if (sc.Canceled()) {
    return true;
}
printf("Check Point 5\n");
//</STEP>
//<STEP>
//<FMT>/tffs0/Library/Formats/DMT1060.XML</FMT>
sc.Exec("FMTL /tffs0/Library/Formats/DMT1060.xml");
sc.Exec("FMTU");
//<IMG>/Cache0/Images/Master.img</IMG>
sc.Exec("IMGL /Cache0/Images/Master.img");
sc.Exec("IMGU");
//<DELY>+5.0000000E+00</DELY>
sc.Pause(5000);
return true;
}

```

sampseq.cpp

This example delays and does nothing except waits to be cancelled, then reports to a serial terminal whether it was cancelled.

```
#include <stdio.h>
#include <QDScriptContext.h>
bool Script_tcan( QDScriptContext& sc )
{
    sc.Exec("CIOY");          // enable printf to serial terminal
    printf("Pause for 10 seconds\n");
    sc.Pause( 10000 );          // pause for 10 seconds

    if (sc.Canceled())
    {
        printf("Script was canceled\n");
    }
    else
    {
        printf("Script completed\n");
    }
    return true;
}
```

testapi.cpp

This example demonstrates the following functions of the API:

- Sending commands and getting responses back
- Pause()
- Multi-line response
- Operators “=” and “+=”
- QDLcd associated API commands: InputInteger(), InputFloat(), and WaitForButtonPress()
- GetUIntResponse()
- GetIntResponse()
- GetDoubleResponse()
- GetBoolResponse()
- Detecting an invalid command

```
#include <QDScriptContext.h>
#include <stdio.h>
bool Script_testapi( QDScriptContext& sc )
{
    // =====
    // Demonstration of sending command and getting response back
    // =====
    // one way to execute a command/query
    sc.Exec("CIOY");          // enable printf to serial terminal
    // another way to execute a command/query
    sc.SetCmdName("VERF?"); // query generator firmware version
    sc.Exec();              // execute the command
    printf("The return value of command \"%s\" is %s\n", sc.GetCmdName(),
sc.GetResponse());
    // =====
    // Demonstration of Pause()
    // =====
    printf("Pause for 5 seconds\n");
    sc.Pause( 5000 );
    if (sc.Canceled()) {
        return true;
    }
    printf("\nWake up from Pause(5000)\n");
    sc.SetCmdName("VERG?"); // query generator gateway versions
    sc.Exec();              // execute the command
    if (sc.Succeed()) {    // was previous command successful?
        printf("\nThe return value of command \"%s\" is %s\n",
sc.GetCmdName(), sc.GetResponse());
    }
}
```



```

else
    printf("\nThere is no response.\n");
// =====
// Demonstration of multi-line responses
// =====
if (sc.Canceled()) {
    return true;
}
// query the first 10 test images in the generator
sc.SetCmdName("IMGQ?");
sc.Append(" 1 10");
sc.Exec();
printf("\nThe response of command \"%s\" has %d lines\n",
sc.GetCmdName(), sc.GetRespLineCount());
printf("\nThe 9th line of response is %s\n", sc.GetResponse(9));
for ( U_INT32 index=1; index<sc.GetRespLineCount()+1; index++ ) {
    printf("Response line %d is: %s \n", index,
sc.GetResponse(index));
}
// =====
// Demonstration of Operator "=" and "+=" overloading
// =====
sc.Reset();
if (sc.Canceled()) {
    return true;
}
sc = "SCRX: ";
sc += "LIST";
sc += "?";
sc.Exec();
printf("\nThe return value of command \"%s\" is %s\n",
sc.GetCmdName(), sc.GetResponse());
// =====
// Demonstration of QDLcd associated APIs, InputInteger() &
InputFloat()
// =====
if (sc.Canceled()) {
    return true;
}
// Test "InputInteger( const char* prompt )" API
INT32 test = sc.InputInteger( "My test:" );
printf("\nThe input of my test is: %d\n", test);
if (sc.Canceled()) {
    return true;
}
test = sc.InputInteger( "Input another one:" );
printf("\nThe input of second input is: %d\n", test);
if (sc.Canceled()) {
    return true;
}
test = sc.InputInteger( "Test limity:", 3, 300 );
printf("\nThe input of test limit is: %d\n", test);
if (sc.Canceled()) {

```

```

        return true;
    }
    double test2 = sc.InputFloat( "Test Float:" );
    printf("\nThe input of Test Float is: %f\n", test2);
    // =====
    // Demonstration of QDLcd associated APIs, WaitForButtonPress()
    // =====
    if (sc.Canceled()) {
        return true;
    }
    sc.ClearLCD();
    sc.Write(1, 1, "Test WaitForButtonPress()");
    sc.Write(0, 3, "<-Yes4");
    sc.Write(16, 3, "No->");
    QDKeyId pressedKey = sc.WaitForKeyPress(5000);
    if ( pressedKey == QD_KEY_LEFT_4 ) {
        printf("\nUser pressed \"Yes\"\n");
    }
    else if ( pressedKey == QD_KEY_RIGHT_4 ) {
        printf("\nUser pressed \"No\"\n");
    }
    else
    {
        printf("\nPressed Invalid Key\n");
    }
// =====
// Demonstration of GetUIntResponse()
// =====
    if (sc.Canceled()) {
        return true;
    }
    sc.SetCmdName("DPTR?");
    //sc.ClearScreen();
    sc.Exec();
    if (sc.Succeed()) {
        printf("\nTest GetUIntResponse(): The return value of command
\"%s\" is %d\n", sc.GetCmdName(), sc.GetUIntResponse());
    }
    else
        printf("\nCommand execution failed.\n");
// =====
// Demonstration of GetIntResponse()
// =====
    if (sc.Canceled()) {
        return true;
    }
    sc.SetCmdName("HRES?");
    //sc.ClearScreen();
    sc.Exec();
    if (sc.Succeed()) {
        printf("\nTest GetIntResponse(): The return value of command
\"%s\" is %d\n", sc.GetCmdName(), sc.GetIntResponse());
    }
}

```

```

else
    printf("\nCommand execution failed.\n");
// =====
// Demonstration of GetDoubleResponse()
// =====
if (sc.Canceled()) {
    return true;
}
sc.SetCmdName("PRAT?");
//sc.ClearScreen();
sc.Exec();
if (sc.Succeed()) {
    printf("\nTest GetDoubleResponse(): The return value of command
\"%s\" is %f\n", sc.GetCmdName(), sc.GetDoubleResponse());
}
else
    printf("\nCommand execution failed. Error is %d\n",
sc.GetError());
// =====
// Demonstration of GetBoolResponse()
// =====
if (sc.Canceled()) {
    return true;
}
sc.SetCmdName("PDAX:RPTG?");
//sc.ClearScreen();
sc.Exec();
if (sc.Succeed()) {
    printf("\nTest GetBoolResponse(): The return value of command
\"%s\" is %d\n", sc.GetCmdName(), sc.GetBoolResponse());
}
else
    printf("\nCommand execution failed.\n");
// =====
// Demonstration of Pause()
// =====
printf("Pause for 6 seconds\n");
sc.Pause( 6000 );
if (sc.Canceled()) {
    return true;
}
printf("\nWake up from Pause(6000)\n");
if (sc.Canceled()) {
    return true;
}
sc.SetCmdName("VERG?");
//sc.ClearScreen();
sc.Exec();

if (sc.Succeed()) {
    printf("\nThe return value of command \"%s\" is %s\n",
sc.GetCmdName(), sc.GetResponse());
}

```

```

else
    printf("\nCommand execution failed.\n");
// =====
// Demonstration of detecting invalid command
// =====
// First, set CancelOnError to be FALSE, the test should continue to
next
    sc.SetCancelOnError( false );
    sc.SetCmdName("VERP?");
    sc.Exec();
    printf("\nThe error status of the invalid command %s is %d\n",
sc.GetCmdName(), sc.GetError());
    if (sc.Canceled()) {
        printf("The test exited because the command is not valid\n");
        return true;
    }
    else
    {
        printf("Script not cancelled. Execution should continue\n");
    }
// Then, set CancelOnError to be TRUE, the test should continue to
next
    sc.SetCancelOnError( true );
    sc.SetCmdName("VERP?");
    sc.Exec();
    printf("\nThe error status of the invalid command %s is %d\n",
sc.GetCmdName(), sc.GetError());
    if (sc.Canceled()) {
        printf("The test exited because the command is not valid\n");
        return true;
    }
    else
    {
        printf("Script not cancelled. Execution should continue\n");
    }
    return true;
}

```

timinglog.cpp

This example demonstrates the ability to output data to a file. It uses the new functions related to file output: fopen(); fclose(); fprintf().

```
#include <stdio.h>

#include <QDScriptContext.h>

extern int fopen();
extern int fclose();
extern int fprintf();

// set up delay between timing measurements as 5000 milliseconds
UINT32 delay = 5000;

bool Script_timinglog( QDScriptContext& sc )
{
    INT32 num = 1;

    // open a text file to write to
    FILE* outfile = fopen("/card0/timing_log.txt","w");
    fprintf( outfile, "Start of timing analyzer log\n\n" );
    fprintf( outfile, "Delay between timing measurements: %d milliseconds\n", delay );
    sc.Exec("DATE?");
    fprintf( outfile, "Measurement start date and time: %s, ", sc.GetResponse());
    sc.Exec("TIME?");
    fprintf( outfile, "%s\n\n", sc.GetResponse());
    fprintf( outfile,
"Number\tSCAN\tPRAT\t\t\tHRAT\tVRAT\t\tHTOT\tHRES\tHSPD\tHSPW\tHSPP\tVTOT\tV
RES\tVSPD\tVSPW\tVSPP\tHVPD\n" );
    fprintf( outfile,
"====\t====\t====\t====\t====\t====\t====\t====\t====\t====\t====\t====\n" );

    // infinite loop until you press Stop on top right
    while (true)
```

```

{
    sc.SetCancelOnError( false);

    // measure the incoming signal
    sc.Exec("TMAU");

    // repeat measurement if there is no incoming signal
    while (sc.Failed())
    {
        sc.Pause(delay);
        sc.Exec("TMAU");
    }

    // if Stop is pressed, close the file and end script
    if (sc.Canceled()) {
        sc.Exec("DATE?");
        fprintf( outfile, "\nMeasurement end date and time: %s, ", sc.GetResponse());
        sc.Exec("TIME?");
        fprintf( outfile, "%s\n\n", sc.GetResponse());
        fprintf( outfile, "End of timing analyzer log\n" );
        fclose( outfile );
        return true;
    }

    // query and write measured timing values to the text file
    fprintf( outfile, "%d\t\t", num);
    sc.Exec("TMAX:SCAN?");
    fprintf( outfile, "%s\t", sc.GetResponse());
    sc.Exec("TMAX:PRAT?");
    fprintf( outfile, "%s\t", sc.GetResponse());
    sc.Exec("TMAX:HRAT?");
    fprintf( outfile, "%s\t", sc.GetResponse());

```

```

sc.Exec("TMAX:VRAT?");
fprintf( outfile, "%s\t", sc.GetResponse());
sc.Exec("TMAX:HTOT?");
fprintf( outfile, "%s\t", sc.GetResponse());
sc.Exec("TMAX:HRES?");
fprintf( outfile, "%s\t", sc.GetResponse());
sc.Exec("TMAX:HSPD?");
fprintf( outfile, "%s\t", sc.GetResponse());
sc.Exec("TMAX:HSPW?");
fprintf( outfile, "%s\t", sc.GetResponse());
sc.Exec("TMAX:HSPP?");
fprintf( outfile, "%s\t", sc.GetResponse());
sc.Exec("TMAX:VTOT?");
fprintf( outfile, "%s\t", sc.GetResponse());
sc.Exec("TMAX:VRES?");
fprintf( outfile, "%s\t", sc.GetResponse());
sc.Exec("TMAX:VSPD?");
fprintf( outfile, "%s\t", sc.GetResponse());
sc.Exec("TMAX:VSPW?");
fprintf( outfile, "%s\t", sc.GetResponse());
sc.Exec("TMAX:VSPP?");
fprintf( outfile, "%s\t", sc.GetResponse());
sc.Exec("TMAX:HVPD?");
fprintf( outfile, "%s\n", sc.GetResponse());

// increase the measurement number counter
num++;

// hard delay until the next measurement
sc.Pause(delay);

// if Stop is pressed, close the file and end script

```

```
if (sc.Canceled()) {
    sc.Exec("DATE?");
    fprintf( outfile, "\nMeasurement end date and time: %s, ", sc.GetResponse());
    sc.Exec("TIME?");
    fprintf( outfile, "%s\n\n", sc.GetResponse());
    fprintf( outfile, "End of timing analyzer log\n" );
    fclose( outfile );
    return true;
}
}
}
```

A Command Reference

Topics in this appendix:

- [Commands by category](#)
- [Commands by name](#)

Commands by category

System

Control

Command	Description
BOIT	Initialize generator (without performing self-calibration)
BOOT	Restart generator (without performing self-calibration)
SCAL	Calibrate generator (using self-calibration circuitry)
UI:MODE	Set generator operating mode (Basic or Browse)
NERR?	Get number of errors in error queue
ERRY?	Retrieve most recent error from error queue
ERRC	Clear all errors in error queue
OERR?	Check for error queue overflow
NOTU	Disables ongoing command execution until communication is complete
TOGG	Enable/disable hot plug setting of source format list via EDID function
INIT	Restore generator RAM storage to factory default condition
DATE	Sets generator system date
TIME	Sets generator system time

Parameters

Command	Description
ASSC	Set analog sync swing calibration factor
AVCM	Set analog video calibration method
AVSC	Set analog video swing calibration factor
CALF	Set analog output calibration factors
DVSC	Set TMDS differential swing calibration factor
RATC	Set pixel rate calibration factor
FRGB	Temporarily set image foreground RGB colors
MODE	Set serial port communications parameters

Tools

Command	Description
VERF?	Get generator firmware version number
VERG?	Get gateway version number
FILE:LOAD	Load file (image, format) on generator
FILE:SCREENCAP	Capture currently displayed image to a bitmap file
LCDS?	Get text displayed on generator LCD display
LEDS?	Get status of generator signals
DEVS?	List all devices
LS?	List contents of current directory
CAT?	View contents of a text file
PWD?	Get current directory name
RM	Remove a file from current directory
TASK?	List current tasks

Network

Command	Description
ENET	Get generator's ethernet MAC address
ENET:IP	Set generator's ethernet IP address
ENET:MASK	Set generator's ethernet subnet mask address

User Profile

Command	Description
USRA	Add user profile
USRU	Create new user profile
USRK	Delete user profile

GPIB (IEEE-488.2 standard)

Commands

Command	Description
*CLS	Clear event status register
*ESE	Set event status enable register value
*ESR?	Get event status register value
*IDN?	Get equipment identification string
*OPC	Set OPC bit in event status register
*RST	Reset generator to known condition
*SRE	Set service request enable register value
*STB	Get status byte register value
GPIB	Set GPIB port address

Port control

Command	Description
*DDT	Execute command on generator when triggered
*TRG	Execute/trigger command on generator
*TST	Perform self-text on generator
*WAI	Wait for command completion before sending prompt
SEOS	Set how generator reads strings

Gating Controls

Command	Description
BLUG	Enable/disable blue video output
GRNG	Enable/disable green video output
REDG	Enable/disable red video output
HPBG	Enable/disable reading hot plug formats
OUTG	Enable/disable all video and sync outputs
SVSG	Set output colors
XVSG	Enable/disable output colors

Images

Control

Command	Description
IMGQ?	Get list of images stored in memory
IMGL	Load an image from a file
IMGU	Update generator with current image edit buffer contents
IMGA	Save image edit buffer contents to a specified filename
IMGK	Delete a saved image file
IMGP	Set default image path
ISUB	Enable/disable alternate versions of images
IVER	Set a image version (normal/alternate)
LEVP , LEVP:R	Set image color component (R, G, B) levels
TOBL	Set signal levels relative to blanking (blacker than black)

Edit

Command	Description
IMGN	Create a new image file
IMGB	Begin an image editing session
IMGE	End an image editing session
IMGS	Save a new image to filename specified by IMGN
ANIM?	Determine if image has animation
DELX	Set horizontal shift for each step of SlideG/SlideRGB image
DELY	Set vertical shift for each step of SlideG/SlideRGB image
DWEL	Set number of frames for each step of SlideG/SlideRGB image
ISTP?	Allow contents of custom image to be copied
MSIZ	Set size of light meter boxes in BriteBox image
NOGA	Disables gamma correction in a custom image
OFFX	Set horizontal offset for large patch of Regulate image
OFFY	Set vertical offset for large patch of Regulate image
PENH	Set height variable for line thickness in EeRise, NAWC, and Slider images
PENW	Set width variable for line thickness in EeRise, NAWC, and Slider images

Command	Description
SPAX	Set horizontal spacing
SPAY	Set vertical spacing
UIDN	Set test string in upper portion of SMPTE133 and Cubes images
XRES	Set horizontal scaling factor
YRES	Set vertical scaling factor

Custom Image Draw

Command	Description
ADOT	Draw a single pixel
ANTI	Use anti-aliasing
CENT	Draw a small cross in center
CROS	Draw a large cross in center
FORM	Draw format data block
GRID	Draw a color crosshatch with boxes
GRIH	Draw equally spaced horizontal lines (grill)
GRIV	Draw equally spaced vertical lines (grill)
HATI	Draw inside-out color crosshatch with boxes
HATO	Draw outside-in color crosshatch with boxes
LIMI	Draw nine markers to define active video area
LINE	Draw a line between two points
OVAL	Draw an oval
PAGE	Fill a rectangular area with a repeating character
RECT	Draw a rectangle with sides parallel to axis of active video
SNUM	Draw sequence step number (when using a sequence)
TBOX	Draw information text box
TBXG	Enable/disable display of information text box specified by TBOX
TEXT	Draw text string
TRIA	Draw a triangle

ImageShift utility

Command	Description
ISHG	Enable/disable image shifting function
ISHQ?	Get list of imageshift files stored in memory
ISHL	Load values from an imageshift file
ISHN	Create a new imageshift file
ISHB	Begin an imageshift file editing session
XISH:HINC	Set horizontal shifting increment
XISH:PATH	Set shift path
XISH:SRCN	Set image for shifting
XISH:TINC	Set time shift increment
XISH:TTYP	Set shifting method
XISH:VINC	Set vertical shifting increment
ISHE	End an imageshift file editing session
ISHS	Save a new imageshift file to filename specified by ISHN
ISHU	Update generator with current imageshift file edit buffer contents
ISHA	Save imageshift file edit buffer contents to a specified filename
ISHK	Delete a saved imageshift file
ISHP	Set default imageshift path

Formats

Control

Command	Description
FMTQ?	Get list of formats stored in memory
FMTL	Load a format from a file
FMTU	Update generator with current format edit buffer contents
FMTA	Save format edit buffer contents to a specified filename
FMTG?	Test format edit buffer contents
FMTK	Delete a saved format file
FMTTP	Set default format path
FMTZ	Clear format storage memory

Edit

Command	Description
FMTN	Create a new format file
FMTB	Begin a format editing session
FMTE	End a format editing session
FMTS	Save a new format to filename specified by FMTN
JDVI	Set upper and lower pixel clock rate limit for DVI output
JLDI	Set pixel clock rate for LDI output
JRAT	Set pixel clock rate
PELD	Set number of data bits in each active pixel
HSIZ	Set horizontal physical size of image displayed
VSIZ	Set vertical physical size of image displayed
USIZ	Set measurement units for HSIZ and VSIZ

Parameters (Video Signal)

Command	Type	Description
XVSI	Interface	Enable/disable video signal interface output
XVSI:IN	Interface	Enable/disable video signal interface input
SSST	Synchronization	Set display sync signal type
GAMC	Gamma Correction	Enable/disable video gamma correction factor
GAMA	Gamma Correction	Set video gamma correction factor
CXAR	Active Format (HDMI)	Set aspect ratio of source image content
EXAR	Active Format (HDMI)	Set aspect ratio of extended image content
SXAR	Active Format (HDMI)	Set natural aspect ratio of video signal format
EXCX	Active Format (HDMI)	Map source image to extended image
SXCX	Active Format (HDMI)	Map CXAR -shaped image to SXAR -shaped aperture
SXEX	Active Format (HDMI)	Map EXAR -shaped image to SXAR -shaped aperture
XAFD	Active Format (HDMI)	Set parameters to support a given AFD code

Command	Type	Description
PXAR?	Active Format (HDMI)	Get aspect ratio of pixels in active regions of raster image
XBBH	Manual Border (HDMI)	Set bottom border height
XLBW	Manual Border (HDMI)	Set left border width
XRBW	Manual Border (HDMI)	Set right border width
XTBH	Manual Border (HDMI)	Set top border height
PELD	Canvas	Set pixel depth
NPPP	Canvas	Set pixel repetition factor
AVST	Analog Video	Set signal output type
AVSS	Analog Video	Set maximum peak-to-peak swing for analog video output
AVPS	Analog Video	Set analog video black pedestal level
AVPG	Analog Video	Enable/disable analog video set-up pedestal
AVCS	Analog Video	Set color subcarrier type for television output
AVCO	Analog Video	Set mapping of video colors to analog video output
ASSS	Analog Sync	Set maximum peak-to-peak swing for composite sync
ASCT	Analog Sync	Set composite sync type for analog video output
EQUF	Analog Sync	Enable/disable equalization pulses in composite sync
ASBG	Analog Sync Gates	Add composite sync to blue analog video output
TSPG	Analog Sync Gates	Enable/disable tri-level sync pulse
ASSG	Analog Sync Gates	Add composite sync to all three analog video outputs
DVST	Digital Video	Set signal type
DVQM	Digital Video	Set quantizing mode
NCPP	Digital Video	Set number of clocks per pixel
NBPC	Digital Video	Set color depth
LMAX	Digital Video	Set maximum digital quantizing level
LMIN	Digital Video	Set minimum digital quantizing level
NLNK	Digital Video	Set number of links used by LVDI digital outputs

Command	Type	Description
BALG	Digital Video	Enable/disable adding DC balancing to Open LVDI digital output
PREG	Digital Video	Enable/disable pre-emphasis to Open LVDI digital outputs
DVSP	Digital Video	Set signal polarity
DVPT	Digital Video	Set output protocol (DVI or HDMI)
DVSM	Digital Video	Set sampling mode
DVSS (OUT1:DVSS, OUT2:DVSS)	Digital Video	Set TMDS differential swing voltage
DSST	Digital Sync	Set digital separate sync type for digital composite sync output
DSCT	Digital Sync	Set composite sync type for digital composite sync output
HSPP	Digital Sync Polarity	Set digital horizontal sync pulse polarity
VSPP	Digital Sync Polarity	Set digital vertical sync pulse polarity
CSPP	Digital Sync Polarity	Set digital composite sync output polarity
FSPP	Digital Sync Polarity	Set digital frame sync pulse polarity
PSPP	Digital Sync Polarity	Set probe pulse polarity
LSPP	Digital Sync Polarity	Set digital line sync pulse polarity
HSPG	Digital Sync Gates	Enable/disable digital horizontal sync output
VSPG	Digital Sync Gates	Enable/disable digital vertical sync output
CSPG	Digital Sync Gates	Enable/disable all digital composite sync outputs
PSPG	Digital Sync Gates	Enable/disable probe pulse on special sync output
LSPG	Digital Sync Gates	Enable/disable digital horizontal sync output
FSPG	Digital Sync Gates	Enable/disable digital frame sync output
PCPG	Digital Sync Gates	Enable/disable pixel clock pulse

Parameters (Video Timing)

Command	Type	Description
PRAT?	Rates	Get current pixel rate setting
HRAT	Rates	Set line frequency
VRAT?	Rates	Get current vertical (field) rate
FRAT?	Rates	Get current vertical rate setting for frame
HTOT	Horizontal	Set total number of pixels per horizontal line
HRES	Horizontal	Set number of active pixels per line
VTOT	Vertical	Set total number of lines per vertical frame
VRES	Vertical	Set number of active pixels per frame
SCAN	Vertical	Set number of fields scanned per frame
RFLD	Vertical	Enable/disable identical video information output for each field of interlaced format
HSPD	Horizontal Sync	Set horizontal sync pulse delay
HSPW	Horizontal Sync	Set width of horizontal sync pulse
HVPD?	Horizontal Sync	Get pixel delay between horizontal and vertical sync pulses
VSPD	Vertical Sync	Set vertical sync pulse delay
VSPW	Vertical Sync	Set vertical sync pulse width
EQUB	Composite Sync	Set equalization interval before vertical sync pulse
EQUA	Composite Sync	Set equalization interval after vertical sync pulse
HVSA	Composite Sync	Set pixel serration period
FSPD	Frame Sync	Set frame sync pulse delay
FSPW	Frame Sync	Set width of frame sync pulse
PSHD	Probe Sync	Set line delay (in pixels)
PSVD	Probe Sync	Set vertical delay
PSPW	Probe Sync	Set pixel width
PSVW	Probe Sync	Set vertical width
PSPM	Probe Sync	Set lines in frame where probe pulse occurs

Parameters (Audio Signal and Timing)

Command	Type	Description
CAUD	Encoding	Set digital audio clips
DASI	Interface	Set digital audio signal interface

Command	Type	Description
DAST	Encoding	Set digital audio signal type
NDAS	Encoding	Set number of digital audio streams
NDAC	Encoding	Set number of digital audio channels (CC parameter in Audio InfoFrame)
NBPA	Encoding	Set number of bits (SS parameter in Audio InfoFrame)
DAXG	Components	Specify gated speaker locations
DAXA	Components	Specify available speaker locations
SDGM	Mix	Set generator SPDIF audio OUT source (HDMI, SPDIF IN or internal)
SDMG	Mix	Set generator audio source (internal or external)
DADG	Mix	Enable/disable audio signal downmixing (DM_I parameter in Audio InfoFrame)
DALS	Mix	Set level shift value for audio signal downmixing (LVS parameter in Audio InfoFrame)
DACA	Channels	Set active audio channels
DACG	Channels	Set gated audio channels
SDAU	SPDIF analyzer	Initiates the measurement of the audio received on the SPDIF In connector of the 882EA
SDAX:ARAT?	SPDIF analyzer	Queries for the sampling rate of the audio received on the SPDIF In connector of the 882EA
SDAX:IECD?	SPDIF analyzer	Queries for the IEC header information of the audio received on the SPDIF In connector of the 882EA
SDAX:CSBA/B?	SPDIF analyzer	Queries for the channel status bits of the audio received on the SPDIF In connector of the 882EA
SAMP	Sinewave	Set amplitude of digital audio stream sinewave output
SMAX?	Sinewave	Get maximum amplitude of digital audio stream sinewave output
SMIN?	Sinewave	Get minimum amplitude of digital audio stream sinewave output
SRAT	Sinewave	Set frequency of digital audio stream sinewave output

Command	Type	Description
ARAT	Digital Audio Timing	Set sampling rate (CT parameter in Audio InfoFrame)
BRAT	Digital Audio Timing	Set bit rate (MBR parameter in Audio InfoFrame)

Test Sequences

Control

Command	Description
SEQQ?	Get list of filenames of stored sequence files
SEQL	Load a sequence from a file
SEQA	Save sequence edit buffer contents to a specified filename
SEQU	Update hardware with current sequence editor contents
SEQK	Delete a saved sequence file
SEQP	Set default sequence path
SMOD	Set sequence mode
DNUM	Enable/display sequence step number display
NSTP?	Get number of sequence steps in the buffer

Edit

Command	Description
SEQN	Create a new sequence file
SEQB	Begin a sequence editing session
STEP	Select a sequence step
SDLY	Set sequence step delay
SEQE	End a sequence editing session
SEQS	Save a new sequence to filename specified by SEQN

Directories

Control

Command	Description
DIRQ?	Get list of directories
DIRL	Copy a directory from memory into directory edit buffer
DIRA	Save current contents of directory edit buffer to a file
DIRU	Install (use) currently loaded directory
DIRK	Delete a directory
DIRP	Set current directory path name

Edit

Command	Description
DIRN	Initialize directory edit buffer
DIRB	Begin a directory editing session
DIRE	End a directory editing session
DIRS	Save contents of directory edit buffer in memory
DIRT	Set directory type to be created
NAMF?	Get index number of file in directory edit buffer
NAMI	Move file to new index position
NAMK	Delete a file from directory edit buffer
NAMQ?	Get list of files in directory edit buffer
NAMY	Delete a file from index position in directory edit buffer

EDID and DDC

Control

Command	Description
DCPG	Enable/disable +5V power signal on output connector
DCPX	Get status of 5V Digital Data Channel (DDC) on output connector
DDCV?	Determine if generator hardware supports VESA DDC communications.
DIDQ	Get list of filenames of stored EDID files

Command	Description
DIDL	Load an EDID from a file
DIDA	Save an EDID to a specified filename
DIDU	Update hardware with current EDID contents
DIDK	Delete a saved EDID file
DIDP	Set default EDID path
EDA	Read/write EDID from/to device connected to HDMI output port
EDID?	Read EDID from connected device
I2CR?	Read EDID data using I2C bus
I2CW	Write EDID data using I2C bus
XDID	Set new EDID structure (DVI/HDMI Analyzer)
EDE	Set HDMI input port with contents of EDID buffer (DVI/HDMI Analyzer)
STRG	Enable/disable SCL low signal stretching (DVI/HDMI Analyzer)

Edit

Command	Description
DIDN	Create a new EDID file
DIDB	Begin an EDID editing session
XDID	Set new EDID structure (DVI/HDMI Analyzer)
DIDE	End an EDID editing session
DIDS	Save a new EDID to filename specified by DIDN

Special Sync Probe Pulse

Command	Description
PSHD	Set line delay (in pixels)
PSPG	Enable/disable probe pulse on special sync output
PSPM	Set lines in frame where probe pulse occurs
PSPP	Set probe pulse polarity
PSPW	Set pixel width
PSVD	Set vertical delay
PSVW	Set vertical width

Color Look-Up Table (LUT)

Command	Description
RGBW	Set RGB levels to within the current lookup table
SLUT	Set colorset for color lookup table

HDMI

Data Island Packet

Command	Description
XACR	Set Audio Clock Regeneration packet
XGDP	Set Generic Control packet
XGCP	Enable/disable Audio/Video Mute (AVMUTE) in general control packet
MUTE	Enable/disable Audio/Video Mute (AVMUTE) feature
DPTG	Set gated packet types
DPTR	Set frequency for General Control packet
DPGU	Update generator with current data island packet content

InfoFrame Packet

Command	Description
XGIF	Set Generic (Vendor-Specific) InfoFrame packet data
XAVI	Set Auxiliary Video Information (AVI) InfoFrame packet data

Command	Description
XSPD	Set Source Product Description InfoFrame packet data
XAUD	Set Audio InfoFrame packet data
XMPG	Set MPEG InfoFrame packet data
DVIC	Sets video identification code in AVI InfoFrame
IFTG	Set gated InfoFrame types
IFTR	Set frequency for InfoFrame types
IFGU	Update generator with current InfoFrame content

HDCP

Command	Description
HDCP? (OUT1:HDCP?, OUT2:HDCP?)	Set number of frames to run test on a specific HDMI output port

DVI/HDMI DisplayPort Signal Analyzer

Commands by name

***CLS**

Clear Status

Class GPIB

Description Clears the Event Status Register, the Status Byte and the output buffer.

Command syntax *CLS

Related commands [*ESR?](#), [*STB](#)

*DDT

Delay Device Trigger

Class Trigger

Description Specifies a command or command string to be executed when the generator is “triggered” with the *TRG command. Only one *DDT command can be pending at a time. The command or query arguments must be enclosed in quotes.

Command syntax *DDT “*command_1; command_2 ... command_n*”

Example *DDT “imgl flat; imgu”
*TRG // to invoke the command line in quotes from the *DDT command

Related commands [*TRG](#)

*ESE

Event Status Enable

Class GPIB

Description Sets the Event Status Enable register to the given mask value. The bits in the Event Status Enable register function as enable bits for each corresponding bit in the Event Status register. That is, when a bit in the Event Status register goes high, and the corresponding bit in the Event Status Enable register is a 1, it is enabled and will cause the ESB bit in the Status Byte register to go high.

The *ESE? query returns the current value of the Event Status Enable register.

Command syntax *ESE *mask*
mask
0 - 255

Example *ESE 8

Query syntax *ESE?

Query response *mask* NL
Where *mask* is in integer NR1 form.

See also: [*CLS](#), [*ESR?](#)

*ESR?

Event Status Register

Class GPIB

Description Returns the current value of the Event Status register. After this command is executed, the Event Status register is cleared. This is the only way of clearing any bit in the Event Status register except by the *CLS command.

Query syntax *ESR?

Returns *registerValue* NL

Where *registerValue* is in integer NR1 form.

Related commands [*CLS](#), [*ESE](#)

*IDN?

IDeNtification

Class	GPIB
Description	Returns an equipment identification string formatted per IEEE-488.2 standards.
Query syntax	*IDN?
Returns	<i>Company,Model,SerialNumber,FirmwareVersion</i> <i>Company</i> Always QuantumData. <i>Model</i> Product model description. <i>SerialNumber</i> Serial number of nonvolatile SRAM module (Dallas chip) in generator. <i>FirmwareVersion</i> Version number of currently installed firmware.
Example	R:*idn? QuantumData,802BT-DVI-AN,7514191,7.38380000

***OPC**

OPeration Complete

Class GPIB

Description Causes the 882 to set the OPC bit in the Event Status register when all operations have been completed. Since there are no overlapping commands, the *OPC command will set the OPC bit immediately when executed.

The *OPC query will put a 1 in the output buffer when all operations are complete.

Command syntax *OPC

Query syntax *OPC?

Returns NL

*RST

ReSet

Class GPIB

Description Performs a device reset. This places the 882 into a known condition. These conditions are:

- IEEE-488 address set to 15
- Status Byte cleared
- Input queue empty
- Output queue empty

Command syntax *RST

Related commands [*CLS](#)

*SRE

Service Request Enable

Class GPIB

Description Sets the Service Request Enable register to the mask value given. The bits in the Service Request Enable register function as enable bits for each corresponding bit in the Status Byte register to enable a condition to request service from the system controller. That is, when a bit in the Status Byte register goes true, and the corresponding bit in the Service Request Enable register is also true, the 882 will request service through the GPIB. The *SRE query returns the current value of the Service Request Enable register.

Command syntax *SRE *mask*
mask
0 - 255

Example *SRE 16

Query syntax *SRE?

Returns *mask* NL
Where *mask* is in integer NR1 form.

Related commands [*STB](#), [*ESE](#)

*STB

Status Byte

Class GPIB

Description Returns the current value of the Status Byte register. The value stored in the Status Byte register is not affected by reading it.

Query syntax *STB?

Returns *statusByte*<NL>

Where *statusByte* is in integer NR1 form.

Related commands [*SRE](#), [*ESR?](#), [*CLS](#)

***TRG**

TRiGger

Class GPIB port control

Description Triggers the generator programmatically. The *TRG command is used to trigger a command or command string entered with the *TRG command.

Command syntax *TRG

Example *DDT "imgl flat;imgu"
*TRG // Invoke the command line in quotes from the *DDT command

Related commands [*DDT](#)

*TST

self TeST

Class GPIB port control

Definition: Causes the 882 to perform a self-test and report the results in a response message. If the self-test fails, an ASCII "1" is placed in the output buffer; otherwise, an ASCII "0" is placed in the output buffer.

Query syntax *TST?

Returns *result*<NL>

Where *result* is in integer NR1 form.

*WAI

WAI for completion suffix

Class GPIB port control

Description Causes the generator to wait until all processes have been completed before sending the prompt. Normally, the generator returns a prompt immediately after either an FMTU, IMGU, ALLU, BOOT, INIT, or SCAL command is received, even before these commands have finished executing. If the system controlling the generator must know when a command has finished executing, use a semicolon to append the suffix ... ;*WAI. .

Command syntax *command*; *WAI

command

FMTU, IMGU, ALLU, BOOT, INIT, or SCAL

Example

```
FMTL vga_m3 // Load a format from memory to buffer
IMGL SMPTE133 // Load the SMPTE RP-133 image to buffer
ALLU; *WAI // Update hardware to current buffer contents and delay
// prompt until all done
```

ADOT

draw A single pixel DOT

Class	Custom image primitive
Description	Draws a single pixel dot. A dot is the smallest graphic element that can be drawn. It uses three parameters: the color and the X and Y coordinates.
Command syntax	<pre>ADOT <i>color</i> <i>x</i> <i>y</i></pre> <p><i>color</i> available colors</p> <p><i>x</i> positive integer number</p> <p><i>y</i> positive integer number</p>
Other required commands	The FMTU command instructs the generator to use the new setting. The ALLU command updates hardware to the new setting and redraws the test image.
Example	<pre>ADOT White 200 300 // Draw white dot at X = 200 Y = 300</pre>

ALLE

end ALL Editor sessions

Class Directory, format, image and sequence editor control

Description Same as entering all of the DIRE, FMTE, IMGE and SEQE commands.

Command syntax ALLE

ALLU

ALL Use

Class System control

Description Checks the current contents of the format buffer for errors. If no errors are found, it reconfigures the signal generating hardware in accordance with the contents. Next, the current test image is re-rendered using the latest system and format parameter data.

Command syntax ALLU

Other required commands This command updates the generator after using the FMTL, IMGL and SEQL commands to load new files from memory. This command also can be used to see the results of work when using commands to edit formats or custom images.

Example

```
FMTL vga_m3 // Load a format from memory to buffer
ALLU // Update hardware to current buffer contents
```

ANIM?

current test image has ANIMation

Class Image editor control

Description Returns a flag indicating if the image currently being displayed is animated.

Query syntax ANIM? *imageName*

Query response 0 = Not animated (static image) or the image was not found.
1 = Animated.

Example ANIM? cubes // to determine if the "cubes" image has animation
1 // response indicates that "cubes" is an animated image

ANTI

ANTI-alias

Class	Image drawing primitives
Description	Causes other primitives to be drawn using anti-aliasing on diagonal edges when appearing anywhere in a custom image. This command affects only television formats on 801GX generators. It causes the leading and trailing edges of rectangles to have controlled rise and fall times.
Command syntax	ANTI
Other required commands	The IMGU or ALLU command must be used to redraw the custom image using anti-aliased primitives.

ARAT

Audio sampling RATE

Class Format parameter setting - Audio signal

Description Sets the sampling rate of the audio stream output from the generator. This sets the CT parameter of the Audio InfoFrame (as specified in EIA/CEA-861-B, table 20).

Command syntax *ARAT rate*

rate

- 192.0E3
- 176.4E3
- 96.0E3
- 88.2E3
- 48.0E3 (default)
- 44.1E3
- 32.0E3

Example *ARAT 48.0E3*
ALLU

Related commands [XAUD](#) (SF parameter)

ASBG

Analog Sync on Blue Gating

Class	Format parameter setting - Analog video signal
Description	Enables and disables adding composite sync to the blue analog video outputs when analog sync is selected (see SSST command) and an analog video signal is being generated (see AVST command). The ASBG? query returns the current setting of ASBG. See the ASSG command description for information on simultaneously controlling red, green and blue sync gating.
Command syntax	<i>ASBG mode</i> <i>mode</i> 0 = OFF 1 = ON
Query syntax	ASBG?
Query response	<i>mode</i>
Other required commands	The FMTU command instructs the generator to use the new setting. The ALLU command updates hardware to the new setting and redraws the test image.
Example	<pre>ASBG 1 // Enable composite sync on blue in buffer FMTU // Update hardware to current buffer contents</pre>

ASCT

Analog Sync Composite Type

Class	Format parameter setting - Analog video signal
Description	Sets the kind of composite sync added to the analog video outputs when analog sync is enabled (see SSST command) and an analog video signal is being generated (see AVST command). The ASCT? query returns the current setting of ASCT. A setting of zero (0) indicates that the ACS sync selection cannot be activated by the operator.
Command syntax	ASCT <i>type</i> <i>type</i> 0 = none 1 = American HDTV ORed 2 = American ORed 3 = American w/serr 4 = American w/serr & eq 5 = European HDTV ORed 6 = European ORed 7 = European w/serr 8 = European w/serr & eq 9 = American HDTV w/serr 10 = American HDTV w/serr & eq 11 = European HDTV w/serr 12 = European HDTV w/serr & eq 13 = Japanese HDTV ORed 14 = Japanese HDTV w/serr 15 = Japanese HDTV w/serr & eq
Query syntax	ASCT?
Query response	<i>type</i>

Other required commands The **SSST** mode must be set to 4, 5, 6, or 7 and the **AVST** type must be set to 1, 2 or 5 in order for the **ASCT** setting to have any affect on the generator's hardware outputs. The **FMTU** command instructs the generator to use the new setting. The **ALLU** command updates hardware to the new setting and redraws the test image.

Example

```
ASCT 2 // Enable Amer ORed comp sync in buffer
SSST 4 // Enable ACS
AVST 2 // Select analog RGB as video type
FMTU // Update hardware to current buffer contents
```

ASGG

Analog Sync on Green Gating

Class	Format parameter
Description	Enables and disables adding composite sync to the green analog video outputs when analog sync is selected (see SSST command) and an analog video signal is being generated (see AVST command). The ASGG? query returns the current setting of ASGG. See the ASSG command description for information on simultaneously controlling red, green and green sync gating.
Command syntax	<i>ASGG mode</i> <i>mode</i> 0 = OFF 1 = ON
Query syntax	ASGG?
Query response	<i>mode</i>
Other required commands	The FMTU command instructs the generator to use the new setting. The ALLU command updates hardware to the new setting and redraws the test image.
Example	<pre>ASGG 1 // Enable composite sync on green in buffer FMTU // Update hardware to current buffer contents</pre>

ASRG

Analog Sync on Red Gating

Class	Format parameter
Description	<p>Enables and disables adding composite sync to the red analog video outputs when analog sync is selected (see SSST command) and an analog video signal is being generated (see AVST command). The ASRG? query returns the current setting of ASRG.</p> <p>See the ASSG command description for information on simultaneously controlling red, green and red sync gating.</p>
Command syntax	<p>ASRG <i>mode</i></p> <p><i>mode</i></p> <p>0 = OFF</p> <p>1 = ON</p>
Query syntax	ASRG?
Query response	<i>mode</i>
Other required commands	The FMTU command instructs the generator to use the new setting. The ALLU command updates hardware to the new setting and redraws the test image.
Example	<pre>ASRG 1 // Enable composite sync on red in buffer FMTU // Update hardware to current buffer contents</pre>

ASSC

Analog Sync Swing Calibration factor

Class	System calibration settings
Description	<p>Sets the analog video calibration (or scaling) factor that's used to adjust the level set by ASSS. Issuing the command with a single factor sets all three analog video channels to the same value. Issuing the command with three factors sets each of the analog video channels to each of the given values. The actual peak-to-peak swing of the analog composite sync signals at the output connectors equals the product of ASSS multiplied by ASSC. The ASSC? query returns the current settings of ASSC. The default factory setting is 1.000 for this parameter.</p> <p>Note: <i>The ASSC parameter is a system level parameter that affects the analog video swing of all formats that are recalled. The ASSC value is retained when the generator is powered down and back up again. Query the current setting of ASSC if you are experiencing problems with low or missing analog composite sync levels. Reinitializing the generator's memory restores the setting to factory default values of 1.000.</i></p>
Command syntax	<p><i>ASSC red_factor, green_factor, blue_factor</i></p> <p>or</p> <p><i>ASSC common_factor</i></p> <p><i>factor</i></p> <p>min = 0.000 (floating point accepted)</p> <p>max = 1.000 (floating point accepted)</p>
Query syntax	<i>ASSC?</i>
Query response	<i>red_factor, green_factor, blue_factor</i>
Example	<pre>ASSC .995 .998 1.00 // Reduce red and green sync levels FMTU // Update hardware to current buffer contents</pre>

ASSG

Analog Sync Signal Gate

Class	Format parameter setting - Analog video signal
Description	Enables and disables adding composite sync to all three analog video outputs when analog sync is selected (see SSST command) and an analog video signal is being generated (see AVST command). This command can take the place of sending all three of the individual ASRG, ASGG, ASBG commands. The ASSG? query returns the current settings of the ASSG?
Command syntax	<i>ASSG red_mode, green_mode, blue_mode</i> or <i>ASSG common_mode</i> <i>mode</i> 0 = OFF 1 = ON (0, 0, 0 or 0, 1, 0 only choices on 801GC-ISA)
Query syntax	ASSG?
Query response	<i>red_mode, green_mode, blue_mode</i>
Other required commands	The SSST type must be 4, 5, 6 or 7 to output analog sync. The FMTU command instructs the generator to use the new setting. The ALLU command updates hardware to the new setting and redraws the test image.
Example	<pre>ASSG 0,1,0 // Enable composite sync on green in buffer FMTU // Update hardware to current buffer contents</pre>

ASSS

Analog Sync Signal Swing

Class	Format parameter setting - Analog video signal
Description	Sets the maximum peak-to-peak swing for any composite sync that is added to any of the three analog video channels. The actual peak-to-peak swing of the analog sync signals at the output connectors equals the product of ASSS multiplied by ASSC. The ASSS? query returns the current setting of ASSS.
Command syntax	<i>ASSS level</i> <i>level</i> min = 0.000 volts (floating point accepted) max = 0.500 volts (floating point accepted)
Query syntax	ASSS?
Query response	<i>level</i>
Other required commands	One or more ASSG modes must be set to ON and the SSST type must be 4, 5, 6 or 7 to output analog sync. The FMTU command instructs the generator to use the new setting. The ALLU command updates hardware to the new setting and redraws the test image.
Example	<pre>ASSS 0.286 // Set sync swing to 286 mV in buffer FMTU // Update hardware to current buffer contents</pre>

AVCM

Analog Video Calibration Method

Class	System calibration setting
Description	Determines how the generator tests and calibrates its analog video outputs. The AVCM? query returns the current setting of AVCM.
Command syntax	AVCM <i>type</i> <i>type</i> 0 = Interpolate 1 = Measure Interpolate 2 = Measure Set Absolute 3 = Test Levels
Query syntax	AVCM?
Query response	<i>type</i>
Example	AVCM 1 // Select Measure Interpolate // type of self cal

AVCO

Analog Video COnfiguration

Class	Format parameter setting - Analog video signal
Description	Sets the mapping of the analog video colors to the video output connections. The AVCO? query returns the current setting of AVCO.
Command syntax	<i>AVCO type</i> <i>type</i> 0 = RGB - R to R, G to G, B to B (Normal) 1 = RBG - R to R, B to G, G to B 2 = GRB - G to R, R to G, B to B 3 = GBR - G to R, B to G, R to B 4 = BRG - B to R, R to G, G to B 5 = BGR - B to R, G to G, R to B
Query syntax	AVCO?
Query response	<i>type</i>
Other required commands	The FMTU command instructs the generator to use the new setting. The ALLU command updates hardware to the new setting and redraws the test image.
Example	<pre>AVCO 5 // Output blue on red chan and red on blue chan FMTU // Update hardware to current buffer contents</pre>

AVCS

Analog Video Color subcarrier Selection

Class	Format parameter setting - Analog video signal
Description	Sets the color subcarrier type used for the television outputs on generator models that have television outputs available. The AVCS? query returns the current setting of AVCS.
Command syntax	<i>AVCS type</i> <i>type</i> 0 = No subcarrier 1 = NTSC-M, 3.579545 MHz (American) 2 = NTSC-44, 4.43361875 MHz (conversion format without phase alternation) 3 = PAL, 4.43361875 MHz (with phase alternation) 4 = PAL-Nc, 3.58205625 MHz (Argentina) 5 = PAL-M, 3.57561149 MHz 6 = PAL-60, 3.57561149 MHz
Query syntax	AVCS?
Query response	<i>type</i>
Other required commands	The FMTU command instructs the generator to use the new setting. The ALLU command updates hardware to the new setting and redraws the test image.
Example	<pre>AVCS 1 // Select standard American NTSC encoding FMTU // Update hardware to current buffer contents</pre>

AVPG

Analog Video Pedestal Gate

Class	Format parameter setting - Analog video signal
Description	Enables and disables the analog video set-up pedestal. The AVPG? query returns the current setting of AVPG.
Command syntax	<i>AVPG mode</i> <i>mode</i> 0 = OFF 1 = ON
Query syntax	AVPG?
Query response	<i>mode</i>
Other required commands	Analog video must be enabled with the AVST command in order to output an analog video signal. The pedestal level is set with the AVPS command. The FMTU command instructs the generator to use the new setting. The ALLU command updates hardware to the new setting and redraws the test image.

Example

```
AVPG 1 // Enable use of a black level pedestal
AVPS 7.5 // Set pedestal level to 7.5 IRE
FMTU // Update hardware to current buffer contents
```

AVPS

Analog Video Pedestal Swing

Class	Format parameter setting - Analog video signal
Description	Sets a black pedestal level between the blanking level (0.0 I.R.E.) and the peak video level (100.0 I.R.E.). The AVPS? query returns the current setting of AVPS.
Command syntax	<i>AVPS level</i> <i>level</i> min = 0.0 I.R.E. max = 100.0 I.R.E.
Query syntax	AVPS?
Query response	<i>level</i>
Other required commands	AVPG must be set to ON to enable the use of the pedestal. The FMTU command instructs the generator to use the new setting. The ALLU command updates hardware to the new setting and redraws the test image.

Example

```
AVPG 1 // Enable use of a black level pedestal
AVPS 7.5 // Set pedestal level to 7.5 IRE
FMTU // Update hardware to current buffer contents
```

AVSC

Analog Video Swing Calibration factor

Class	System parameter setting
Description	<p>Sets the analog video calibration (or scaling) factor that is used to adjust the level set by AVSS. Issuing the command with a single factor sets all three analog video channels to the same value. Issuing the command with three factors sets each of the analog video channels to each of the given values. The actual peak-to-peak swing of the analog video signals at the output connectors equals the product of AVSS multiplied by AVSC. The AVSC? query returns the current setting of AVSC for each channel. The default factory settings are 1.000 for AVSC.</p> <p>Note: <i>The AVSC parameter is a system level parameter that affects the analog video swing of all Formats that are recalled. The AVSC value is retained when the generator is powered down and back up again. Query the current value of the AVSC if you are experiencing low or missing analog video levels.</i></p>
Command syntax	<p><i>AVSC red_factor, green_factor, blue_factor</i></p> <p>or</p> <p><i>AVSC common_factor</i></p> <p><i>common_factor</i></p> <p>min = 0.000 (floating point accepted)</p> <p>max = 1.000 (floating point accepted)</p>
Query syntax	AVSC?
Query response	<i>red_factor, green_factor, blue_factor</i>
Other required commands	The FMTU command instructs the generator to use the new setting on the current format.
Example	<pre>AVSC 1.000 .995 .998 // Reduce green and blue levels FMTU // Apply new factors to current format</pre>

AVSS

Analog Video Signal Swing

Class	Format parameter setting - Analog video signal
Description	Sets the maximum peak-to-peak swing for all three analog video channels. The actual peak-to-peak swing of the analog video signals at the output equals the product of AVSS multiplied by AVSC . The AVSS? query returns the current setting of AVSS.
Command syntax	<i>AVSS level</i> <i>level</i> 0.000 to 1.000 volts (floating point accepted)
Query syntax	AVSS?
Query response	<i>level</i>
Other required commands	Analog video must be enabled with the AVST command in order to output an analog video signal. The FMTU command instructs the generator to use the new setting. The ALLU command updates hardware to the new setting and redraws the test image.
Example 1	This example uses the AVSS command changes the output level of the NTSC format from 714mV to 500mV. <pre>FMTL NTSC FMTB AVSS 0.5 FMTE FMTA NTSC_1</pre>
Example 2	This example enables analog video, and sets the video swing. <pre>AVST 2 // Select RGB component color video in buffer AVSS 0.714 // Set to 714 mV in buffer FMTU // Update hardware to current buffer contents</pre>
Example 3	This example changes the sync level from 286mV to 200mV, and sets the video output level at 500mV. <pre>FMTL NTSC FMTB ASSS 0.2 AVSS 0.7 FMTE FMTA NTSC_1</pre>

AVST

Analog Video Signal Type

Class	Format parameter setting - Analog video signal
Description	Establishes the type of signal that appears on the analog video outputs of the generator. The AVST? query returns the current setting of AVST.
Command syntax	<p>AVST <i>type</i></p> <p><i>type</i></p> <ul style="list-style-type: none">0 = none1 = Analog Y (grayscale)2 = Analog RGB (color)3 = CVBS or S-Video grayscale4 = CVBS or S-Video color5 = Analog YPrPb (old SMPTE 240M HDTV)6 = Analog YPrPb ITU BT.601 (ANSI/SMPTE 170M TV)7 = Analog YPrPb SMPTE RP177 HDTV8 = YPrPb ITU-R BT.709 HDTV
Query syntax	AVST?
Query response	<i>type</i>
Other required commands	DVST must be set to zero when analog video is used. The FMTU command instructs the generator to use the new setting. The ALLU command updates hardware to the new setting and redraws the test image.
Example	<pre>DVST 0 // Disable digital video AVST 2 // Select RGB component color video ALLU // Update hardware and redraw test image</pre>

BALG

dc BALancing Gate

Class	Format parameter setting - Digital video signal
Description	Enables and disables adding DC balancing to the Open LVDI digital outputs on generators that support LVDI outputs. FPD-Link compatible displays use unbalanced (BALG 0), while OpenLDI displays use balanced (BALG 1). The BALG? query returns the current setting of BALG.
Command syntax	BALG <i>mode</i> <i>mode</i> 0 = OFF 1 = ON
Query syntax	BALG?
Query response	<i>mode</i>
Other required commands	FMTU or ALLU

BLUG

BLUe Gate

Class Video Gate

Description Toggles the blue video signal gate.

Command syntax `BLUG mode`
mode
0 disable
1 enable

Query syntax `BLUG?`

Query response 0 or 1

Other required commands [ALLU](#) to invoke the command.

Related commands [GRNG](#), [REDG](#)

Example `BLUG 0; ALLU // disable blue video component`

BOIT

BOot and **I**nITialize

Class System control

Description Initializes the generator without going through a self-calibration.

Command syntax BOIT

BOOT

warm BOOT

Class System control

Description Causes the generator to go through its standard power-up procedure. Self-calibration is not performed. The procedure checks all RAM storage locations for corrupt data. This command is equivalent to turning the generator off and then on.

Command syntax BOOT

BRAT

Bit RATE

Class Format parameter setting - Digital audio signal

Description Sets the bit rate (in Hz) for an external compressed audio source. This sets the MBR parameter of the Audio InfoFrame (as specified in EIA/CEA-861-B).

The BRAT? query returns the current compressed digital audio bit rate

Command syntax BRAT *rate*
rate
0.0 (audio is not compressed)
8000, 16000, 24000 (or higher multiple of 8,000)

Query syntax BRAT?

Example BRAT 32000
IFGU

Related commands [XAUD](#) (MBR parameter)

CALF

analog video CALibration Factors

Class	System calibration settings
Description	<p>Sets the analog output calibration factors to values other than those set by the generator's own self-calibration function. Each channel is calibrated using two independent zero calibration points, and two independent slope calibration points. Interpolation equations for the different video types are used to set the caldac values that controls the output sync and voltage levels to the correct values.</p> <p>TV calibration uses two factors for NTSC output, and two factors for PAL output.</p> <p>Note: <i>Sending bad calibration factors to the generator via the CALF command can hang the generator. If the generator hangs it will have to be reinitialized.</i></p>
Command syntax	<p>CALF <i>zero500R, zero50R, slope1500R, slope1000R, zero500G, zero50G, slope1500G, slope1000R, zero500B, zero50B, slope1500B, slope1000B, ntsc714, pal700, ntsc_blank, pal_blank</i></p> <p><i>zero500R</i> Red calibration factor from 0 (most negative) to 4095 (least negative) at -1.0V.</p> <p><i>zero50R</i> Red calibration factor from 0 (most negative) to 4095 (least negative) at -100mV.</p> <p><i>slope1500R</i> Red calibration factor from 0 (maximum swing) to 4095 (minimum swing) at 2.0V.</p> <p><i>slope1000R</i> Red calibration factor from 0 (maximum swing) to 4095 (minimum swing) at 1.4V.</p> <p><i>zero500G, zero50G, slope1500G, slope1000R</i> Green calibration factors.</p> <p><i>zero500B, zero50B, slope1500B, slope1000B</i> Blue calibration factors.</p> <p><i>ntsc714</i> Factor from 0 (maximum swing) to 4095 (minimum swing) for NTSC output level at 714mV. The <i>ntsc714</i> and <i>ntsc_blank</i> values are interrelated.</p> <p><i>pal700</i> Factor from 0 (maximum swing) to 4095 (minimum swing) for PAL output level at 700mV.</p> <p><i>ntsc_blank</i> Factor from 0 (least negative) to 4095 (most negative) used to set the zero level of the NTSC output at 0.0 IRE.</p>

pal_blank

Factor from 0 (least negative) to 4095 (most negative) used to set the zero level of the PAL output at 0.0 IRE.

Query syntax CALF?

Related commands The [AVSC](#) command matches the levels for the three analog video channels. The [ALLU](#) command updates the signal generating hardware to the new settings and redraws the test image.

Example CALF 1090, 2590, 1992, 3223, 1149, 2634, 2059, 3278, 1001, 2506, 1993,
3221, 781, 780, 3387, 3513 // Set new factors
ALLU // Use new factors

CAT?

Class Tools

Description Lists the contents of a file.

Query syntax CAT? file
file.ext
any valid text file name

Query response Contents of text file

Related commands None

Example

```
CAT?
<?xml version="1.0" encoding="UTF-8" ?>
<DATAOBJ>
  <HEADER TYPE="LIB" VERSION="1.0" >
    <DISPNAME>FormatVESAClassQD</DISPNAME>
  </HEADER>
  <DATA>
    <TYPE>SOURCE</TYPE>
    <NAME>/tffs0/Library/Formats/DMT0659.xml</NAME>
    <NAME>/tffs0/Library/Formats/DMT0660.xml</NAME>
    <NAME>/tffs0/Library/Formats/DMT0672.xml</NAME>
    .
    .
    .
    <NAME>/tffs0/Library/Formats/DMT2060.xml</NAME>
    <NAME>/tffs0/Library/Formats/DMT2075.xml</NAME>
    <NAME>/tffs0/Library/Formats/SMT0660.xml</NAME>
    <NAME>/tffs0/Library/Formats/SMT0660D.xml</NAME>
    <NAME>/tffs0/Library/Formats/SMT0760H.xml</NAME>
    <NAME>/tffs0/Library/Formats/SMT0760V.xml</NAME>
  </DATA></DATAOBJ>
```

CAUD

Compressed AUDIO output

Class	Audio
Description	Enables you to play compressed audio out the 882E HDMI output. You can use this command with any pattern in the generator.
Command syntax	<p>CAUD <i>clip_index</i></p> <p><i>clip_index</i></p> <p>an index representing the audio clip:</p> <ul style="list-style-type: none">1:DTS, 5.1, 48000.00 [dts-48kHz-1509kbps-51ch.wav.pcm]2:DTS(ES), 6.1, 48000.00 [DTES-ES-48kHz-1509kbps-61ch.wav.pcm]3:DTS(HDHRA), 7.1, 192000.00 [dtshdhra-48kHz-5376kbps-71ch.wav.pcm]4:DTS(HDHRA), 5.1, 192000.00 [dtshdhra-48kHz-3840kbps-51ch.wav.pcm]5:DTS(HDHRA), 7.1, 192000.00 [dtshdhra-96kHz-5760kbps-71ch.wav.pcm]6:DTS(HDMA), 5.1, 192000.00 [dtshdma-48kHz-VBR-51ch-HDMI_HBR.ba.pcm]7:DTS(HDMA), 7.1, 192000.00 [dtshdma-48kHz-VBR-71ch-HDMI_HBR.ba.pcm]8:DOLBY(AC3), 2.0, 48000.00 [2khz2ch-0dB_ac3.pcm]9:DOLBY(EAC3), 2.0, 192000.00 [1khz2ch-20dB_ec3.pcm]10:DOLBY(EAC3), 5.1, 192000.00 [1khz51ch-20dB_ec3.pcm]11:DOLBY(EAC3), 7.1, 192000.00 [1khz71ch-1frame_ec3.pcm]12:DOLBY(TRUEHD), 7.1, 192000.00 [1khz71ch-20dB_mlp.pcm]13:DOLBY(TRUEHD), 2.0, 192000.00 [nxt2ch2s.mlp.pcm]
Query syntax	<p>CAUD?</p> <p><i>list</i></p> <p>a list of compressed audio formats is shown</p>
Example 1	<pre>CAUD? // Sends an AC3 clip named "AC3Clip1" out the HDMI output 1:DTS, 5.1, 48000.00 [dts-48kHz-1509kbps-51ch.wav.pcm] . . . 8:DOLBY(AC3), 2.0, 48000.00 [2khz2ch-0dB_ac3.pcm] . . . 13:DOLBY(TRUEHD), 2.0, 192000.00 [nxt2ch2s.mlp.pcm]</pre>
Example 2	<pre>CAUD 8 // Sends a 2 channel Dolby AC3 clip with 192kHz sampling rate at 0dB out the HDMI output.</pre>

CENT

draw video CENTERing markers

Class	Custom image primitive
Description	Draws a small cross in the center of active video. If the format has an even number of active pixels, the vertical line is 2 pixels thick. The horizontal line is 2 pixels thick if the format has an even number of active lines. The primitive uses a single parameter, the color of the cross.
Command syntax	<code>CENT <i>color</i></code> <code><i>color</i></code> available colors
Other required commands	The FMTU command instructs the generator to use the new setting. The ALLU command updates hardware to the new setting and redraws the test image.
Example	<pre>CENT red // Draw a small red cross in center of active video ALLU // Update hardware to current buffer contents</pre>

CROS

draw a centered CROSSs

Class	Custom image primitive
Description	Draws a large centered cross that fills the active video area. The vertical line is 2 pixels thick if the format has an even number of active pixels. The horizontal line is 2 pixels thick if the format has an even number of active lines. The primitive uses a single parameter, the color of the cross.
Command syntax	<code>CROS <i>color</i></code> <code><i>color</i></code> available colors
Other required commands	The FMTU command instructs the generator to use the new setting. The ALLU command updates hardware to the new setting and redraws the test image.
Example	<pre>CROS magenta // Draw a large cross in the center of the active video ALLU // Update hardware to current buffer contents</pre>

CSPG

Composite Sync Pulse Gate

Class	Format parameter setting - Synchronization
Description	Enables and disables all of the digital composite sync outputs when digital composite sync is selected via the SSST command (SSST = 3). The CSPG? query returns the current setting of CSPG.
Command syntax	<i>CSPG mode</i> <i>mode</i> 0 = OFF 1 = ON
Query syntax	CSPG?
Query response	0 or 1
Other required commands	In order to use digital composite sync, it must be selected with the SSST command. The FMTU command instructs the generator to use the new setting. The ALLU command updates hardware to the new setting and redraws the test image.
Example	<pre>CSPG 1 // Enable dig comp sync in buffer SSST 2 // Choose digital comp sync type in buffer FMTU // Update hardware to current buffer contents</pre>

CSPP

Composite Sync Pulse Polarity

Class	Format parameter setting - Synchronization
Description	Establishes the logic sense of the digital composite sync output. The CSPP? query returns the current setting of CSPP.
Command syntax	CSPP <i>polarity</i> <i>polarity</i> 0 = active-low (negative going pulse) 1 = active-high (positive going pulse)
Query syntax	CSPP?
Query response	0 or 1
Other required commands	In order to use digital composite sync, it must be gated on with the CSPG command and selected with the SSST command. The FMTU command instructs the generator to use the new setting. The ALLU command updates hardware to the new setting and redraws the test image.
Example	<pre>CSPG 1 // Enable dig comp sync in buffer CSPP 1 // Select active hi in buffer SSST 2 // Choose digital comp sync type in buffer FMTU // Update hardware to current buffer contents</pre>

CXAR

Content Aspect Ratio

Class Format parameter setting - Active Video

Description Sets the aspect ratio of the source image content.

Command syntax CXAR *aspect_ratio*

aspect_ratio

0.75 to 2.39

The following table provides a listing of established aspect ratios.

Aspect Ratio	Symbol	Description	Examples
0.750	OT or T ₉₀	Television Portrait	3x4, 480x640, 600x800, 768x1024, 960x1280, 1200x1600
0.800	OG or G ₉₀	Workstation Graphics Portrait	4x5, 1024x1280, 1280x1600
1.000	Q	Quadrate, "Square"	1x1, 512x512, 1024x1024
1.250	G	Workstation Graphics	5x4, 1280x1024, 1600x1280
1.333...	T (A) ¹	SDTV / Silent Film	4x3, 640x480, 800x600, 1024x768, 1280x960, 1600x1200
~1.37	C (B) ¹	Academy ² "Classic" with sound	~4x3, 0.825x0.602 SMPTE RP40 35mm "C"
1.444...	I	IMAX™	13x9, IMAX™
1.500	V (T) ¹	Vista Vision™	3x2, 1152x768 Apple Computer (uncropped) Vista Vision™
1.555...	M (V) ¹	Mid	14x9, AFD Shoot and Protect (half-way between 4x3 and 16x9)
1.600	D	16 Decimal	16x10, 1728x1080, 1280x800, see VESA CVT 1.0
1.666...	E	European Film, "1.66	5x3, 1200x720, 1280x768, 1800x1080
1.750	Z	Old Film	7x4, Old Metro-Goldwyn-Mayer and Disney Films
1.777...	H	HDTV	16x9, 1280x720, 1920x1080
~1.85	A (F) ¹	Film Standard (USA)	~13x7, 1280x692, 1920x1038, 0.825x0.446 SMPTE RP40 35mm "A"
2.000	U	Univisum™	2x1, 1280x640, 1920x960
~2.20	F (M) ¹	"Flat", MPEG "20x9"	~11x5, 1280x582, 1920x874, 1.912x0.870 SMPTE RP91 70mm
~2.39	B (C) ¹	Anamorphic Cinema, "2.35" ³	~12x5, 1280x536, 1920x804, 1.650x0.690 SMPTE RP40 35mm "B"

1. The letters in parenthesis are the letters that we used to use, before we updated our aspect ratio symbols for compatibility with existing film industry standards (i.e. the symbols defined in SMPTE RP40).
2. In 1932, the shape of film was changed from 1.33:1 to 1.37:1 in order to better accommodate the new optical soundtrack that was added a few years earlier. This slightly wider shape is the true aspect ratio of "classic" film. The aperture is commonly referred to as "Academy" and was the shape of the vast majority of U.S. films produced until the 1950s.
3. Sometimes called "2.35", which was the aspect ratio before it was changed to 2.39:1 in 1971 to keep splices from showing up in the projected image.

Related commands [EXAR](#), [SXAR](#)

Example CXAR 1.33 //Sets 4:3 picture aspect ratio for source content
FMTU

DACA

Digital Audio Channels Available

Class Format parameter setting - Audio signal

Description Specifies which audio channels are active.

Command syntax *DACA mask*

mask

0 to 3, based on following table.

Channel	1	2
Bit	0	1
Value	1	2

Normally, each type of audio content is assigned to a particular channel and is always output on that channel when present. There is one exception to this rule: rear center (RC) content is switched from channel 5 to 7 whenever rear left (RL) content is simultaneously present. To simplify this, RC content is thus treated as if it were two different types of content: RC5 and RC7. When RL content is not present, RC content is output on channel 5 as RC5 content. When RL content is present, RC content is output on channel 7 as RC7 content.

Setting DACA will automatically set [DAXA](#) and [XAUD:CA](#) parameters to a corresponding value (see table below).

DACA	3
DAXA	3
XAUD:CA	0

Note: If DACA is set to a value not found in the table above, then other parameters will not be automatically set and an error will be generated if the format is loaded while this condition exists.

mask

0 to 255 (based on the value in the table below).**Notes:**

- Setting DACA will automatically set [DAXA](#) and [XAUD:CA](#) parameters to a corresponding value (see table below). However, in the case of DACA values 243, 247, 251, and 255, two sets of DAXA and XAUD:CA values are possible. In this case, DAXA and XAUD:CA settings will be based on those highlighted (in grey) in the table.
- If DACA is set to a value not found in the table above, then other parameters will not be automatically set and an error will be generated if the format is loaded while this condition exists.

Example DACA 3 //specifies audio channels 1 and 2
DACG 3 //gates audio channels 1 and 2
FMTU

Related commands [DACG](#)

DACG

Digital Audio Channel Gate

Class Format parameter setting - Audio signal

Description Specifies which audio channels are gated (on).

Command syntax `DACG mask`

mask

0 to 3 (based on the value in the table below).

Channel	1	2
Bit	0	1
Value	1	2

Example `DACA 3 //specifies audio channels 1 and 2`
`DACG 3 //gates audio channels 1 and 2`
`FMTU`

Related commands [DACA](#)

DADG

Digital Audio Down-mix Gate

Class Format parameter setting - Audio signal

Description Enables or disables downmixing of an audio signal. This sets the DM_I parameter of the Audio InfoFrame (as specified in EIA/CEA-861-B, table 24).

Command syntax DADG *mode*
mode
 1 = enable
 0 = disable

Example DADG 1
 FMTU
 IFGU

Related commands [XAUD](#) (DMI parameter), [DALS](#)

DALS

Digital Audio Level Shift Value

Class Format parameter setting - Audio signal

Description Sets the level shift value (in decibels) for downmixing of the audio signal. This sets the LSV parameter of the Audio InfoFrame (as specified in EIA/CEA-861-B, table 23).

Command syntax DALS *x*
x
0 - 15 (dB)

Example DALS 5
FMTU
IFGU

Related commands [XAUD](#) (LSV parameter), [DADG](#)

DASI

Digital Audio Signal Interface

Class Format parameter setting - Audio signal

Description Sets the digital audio signal interface.

Command syntax DASI *interface*
interface
0 = none
1 = SPDIF

Example DASI 1
IFGU

DAST

Digital Audio Signal Type

Class Format parameter setting - Audio signal

Description Sets the digital audio signal type for an audio signal. This sets the CT parameter of the Audio InfoFrame (as specified in EIA/CEA-861-B, table 19).

Command syntax DAST *type*

type

0 = void

1 = IEC 60958-3 Consumer LPCM

Example DAST 1

IFGU

Related commands [XAUD](#) (CT parameter)

DATE

DATE

Class System parameter

Description Sets the system date in the 882.

Command syntax DATE *mm dd yyyy*

mm

01 - 12

dd

01 - 31

yyyy

2000 -

Query syntax DATE?

mm dd yyyy

Example 1 DATE 09 11 2008

Example 2 DATE?
01 11 2008

Related commands [TIME](#)

DAXA

Digital Audio Content Available

Class Format parameter setting - Audio signal

Description Specifies which speaker locations are available (present).

Command syntax DAXA *mask*

mask

0 to 3 (based on the value in the table below).

Normally, each type of audio content is assigned to a particular channel and is always

Content	FR	FL
Bit	1	0
Value	2	1

output on that channel when present. There is one exception to this rule: rear center (RC) content is switched from channel 5 to 7 whenever rear left (RL) content is simultaneously present. To simplify this, RC content is thus treated as if it were two different types of content: RC5 and RC7. When RL content is not present, RC content is output on channel 5 as RC5 content. When RL content is present, RC content is output on channel 7 as RC7 content.

Setting DAXA will automatically set [DACA](#) and [XAUD:CA](#) parameters to a corresponding value (see table below). However, this method should not be used to gate channels. Instead, [DAXG](#) should be used after all of the available channels have been selected.

DAXA	3
DACA	3
XAUD:CA	0

Note: If DAXA is set to a value not found in the table above, then other parameters will not be automatically set and an error will be generated if the format is loaded while this condition exists.

Example DAXA 3 //specifies FR and FL as having audio content
DAXG 3 //gates FR and FL content
FMTU

Related commands [DAXG](#)

DAXG

Digital Audio Content Gate

Class Format parameter setting - Audio signal

Description Specifies which speaker locations are gated (on).

Command syntax DAXG *mask*

mask

0 to 3 (based on the value in the table below).

Content	FR	FL
Bit	1	0
Value	2	1

Example DAXA 3 //specifies FR and FL as having audio content
DAXG 3 //gates FR and FL content
FMTU

Related commands [DAXA](#)

DCBM

Display Code Bit Mask

Class	Direct processor control
Description	Sets the 4-bit binary bit mask used by the DCRD? query. The mask is entered as the decimal equivalent of a 4-bit binary number. The binary number represents the masking of the individual sense lines from M3 (MSB) to M0 (LSB). The DCBM? query returns the current setting of DCBM.
Command syntax	DCBM <i>mask</i> <i>mask</i> 0 = 0 0 0 0 8 = 1 0 0 0 1 = 0 0 0 1 9 = 1 0 0 1 2 = 0 0 1 0 10 = 1 0 1 0 3 = 0 0 1 1 11 = 1 0 1 1 4 = 0 1 0 0 12 = 1 1 0 0 5 = 0 1 0 1 13 = 1 1 0 1 6 = 0 1 1 0 14 = 1 1 1 0 7 = 0 1 1 1 15 = 1 1 1 1
Query syntax	DCBM?
Query response	<i>mask</i>
Other required commands	The FMTU command instructs the generator to use the new setting. The ALLU command updates hardware to the new setting and redraws the test image.
Example	DCBM 7 // Set mask to read sense lines 0, 1 and 2 only FMTU // Update hardware to current buffer contents

DCEX

Display Code EXpected

Class Format parameter settings

Description Sets up the display code that is expected from a display connected to the generator. The code is determined by one or more sense lines being connected to ground by the display. Many video controller cards for the Apple Macintosh II and VGA type cards for the IBM-PC sample the status of the display code sense lines. The information then sets up one of several different operating modes to match a particular display. An improper display code may make the controller card or display appear to malfunction.

The DCEX? query first performs a logical AND operation with the display code bit mask and the actual display code that's sensed. The decimal equivalent of the result then is returned. The mask is set with the DCEX command.

The expected setting and the actual result are both shown in the Format test image. They have no effect how a given format generates a set of test signals.

Command syntax DCEX *code*

code

0 = 0 0 0 0	8 = 1 0 0 0
1 = 0 0 0 1	9 = 1 0 0 1
2 = 0 0 1 0	10 = 1 0 1 0
3 = 0 0 1 1	11 = 1 0 1 1
4 = 0 1 0 0	12 = 1 1 0 0
5 = 0 1 0 1	13 = 1 1 0 1
6 = 0 1 1 0	14 = 1 1 1 0
7 = 0 1 1 1	15 = 1 1 1 1

Query syntax DCEX?

Query response *code*

Other required commands The [FMTU](#) command instructs the generator to use the new setting. The [ALLU](#) command updates hardware to the new setting and redraws the test image.

Example

```
DCBM 7 // Set mask to read sense lines 0, 1 and 2 only
DCEX 5 // Only lines 0 and 1 should be grounded
FMTU // Update hardware to current buffer contents
```

DCPG (OUT1:DCPG, OUT2:DCPG, AV:DCPG, VGA:DCPG) Data Channel Power Gate

Class EDID and DDC control

Description Enables and disables the +5V power signal at the specified connector by writing to a latch. The [OUT1|OUT2|AV|VGA]:DCPG? query reads back the latched bit at the specified connector.

Command syntax DCPG *option*

connector:DCPG *option*

option

0 = disable +5V power

1 = enable +5V power

connector

OUT1, OUT2 = HDMI OUT 1 or HDMI OUT 2 connector

AV = SPDIF/AV connector

VGA = VGA connector

Query syntax DCPG

connector:DCPG?

connector

OUT1, OUT2 = HDMI OUT 1 or HDMI OUT 2 connector

AV = SPDIF/AV connector

VGA = VGA connector

Example 1 OUT1:DCPG 0 // disables +5V power on the HDMI output 1
DCPU // initiates the command

Example 2 VGA:DCPG 1 // enables +5V power on the VGA output

Example 3 DCPG 1 // enables +5V power on all connectors
DCPU // initiates the command

Example 4 OUT2:DCPG? // queries +5V power on HDMI output 2

Example 5 DCPG? // reads back the logical AND of all connectors

Related commands [DCPX? \(OUT1:DCPX?, OUT2:DCPX, AV:DCPX?, VGA:DCPX?\)](#)

DCPX? (OUT1:DCPX?, OUT2:DCPX, AV:DCPX?, VGA:DCPX?) Data Channel Power Overcurrent

Class EDID and DDC control

Description Queries the status of the 5V display data channel (DDC) power level at the specified output connector.

Query syntax DCPX?

connector

OUT1, OUT2 = HDMI OUT 1 or HDMI OUT 2 ports

AV = SPDIF/AV connector

VGA = VGA connector

Returns 0 or 1

0 = OK

1 = overcurrent (for example, shorted)

Example 1 OUT1:DCPX? // queries the DDC power level of HDMI output connector 1
0

Example 2 OUT2:DCPX? // queries the DDC power level of HDMI output connector 2
1

Example 3 DCPX? // reads back the logical AND of all connectors
0

Related commands [DCPG \(OUT1:DCPG, OUT2:DCPG, AV:DCPG, VGA:DCPG\)](#)

DDCV?

DDC Version supported

Class	EDID and DDC control
Description	The DDCV? query returns a status flag indicating if the generator hardware supports VESA DDC communications.
Query syntax	DDCV?
Query response	0 or 1 0 = no DDC support 1 = DDC supported
Example	DDCV? // Return DDC support information

DELX

slider image DELta X

Class	Image editor control
Description	Sets the amount of horizontal shift that occurs for each step of the SlideG and SlideRGB built-in images. The command is also used to set the horizontal size of the white patch used in the Regulate image. The DELX? Query returns the current DELX setting.
Command syntax	DELX <i>delta_x</i> <i>delta_x</i> horizontal distance in pixels
Query syntax	DELX?
Query response	<i>delta_x</i>
Example	<pre>DELX 8 // Set H shift to 8 pixels per step DELY 3 // Set V shift to 3 pixels per step DWEL 2 // Display each step for 2 frames IMGL "SlideG" // Select Image that uses DELX and DELY IMGU // Draw the Image</pre>

DEVS?

DEVIceS?

Class	Tools
Description	Lists all devices.
Query syntax	DEVS?
Query response	List of devices
Related commands	None

Example DEVS?
drv name
0 \null
1 \tyCo\0
3 \card0
5 QDEW023:
6 \vio
7 \tgtsvr
3 \ram20K
3 \ramNV
3 \tffs0
2 \pipe\cli
8 \pty\remote0.S
9 \pty\remote0.M

DELY

slider image DELta Y

Class	Image editor control
Description	Sets the amount of vertical shift that occurs for each step of the SlideG and SlideRGB built-in images. The command is also used to set the vertical size of the white patch used in the Regulate image. The DELY? Query returns the current DELY setting.
Command syntax	DELY <i>delta_y</i> <i>delta_y</i> vertical distance in pixels
Query syntax	DELY?
Query response	<i>delta_y</i>
Example	<pre>DELX 8 // Set H shift to 8 pixels per step DELY 3 // Set V shift to 3 pixels per step DWEL 2 // Display each step for 2 frames IMGL "SlideG" // Select Image that uses DELX and DELY IMGU // Draw the Image</pre>

DIDA

eDID save As file

Class EDID and DDC control

Description Saves an EDID to the filename specified by *filename*.

Command syntax DIDA *filename*

filename

a valid MS-DOS filename (8 characters minus any extension)

Example This example loads an EDID file, edits it, and saves the changes under a new filename, *myedid8*.

```
DIDL myedid7      // loads the EDID file named myedid7
DIDB              // begins an edid editing session
XDID 19 A E88A82A0564796240F48 // edits EDID at 19 for 10 (0x0A) bytes
DIDE              // ends an edid editing session
DIDA myedid8     // saves the changes to the filename myedid8
```

Related commands [DIDB](#), [DIDE](#), [DIDK](#), [DIDL](#), [TASK?](#), [DIDP](#), [DIDQ](#), [DIDS](#), [DIDU](#), [EDA<port>:GDID](#), [EDA<port>:PDID](#), [XDID](#)

DIDB

eDID editing Begin

Class EDID and DDC control

Description Marks the beginning of an EDID editing session.

Command syntax DIDB

Example

```
DIDL myedid7      // loads the EDID file named myedid7
DIDB              // begins an edid editing session
XDID 19 A E88A82A0564796240F48 // edits EDID at 19 for 10 (0x0A) bytes
DIDE             // ends an edid editing session
DIDA myedid8     // saves the changes to the filename myedid8
```

Related commands [DIDA](#), [DIDE](#), [DIDK](#), [DIDL](#), [TASK?](#), [DIDP](#), [DIDQ](#), [DIDS](#), [DIDU](#), [EDA<port>:GDID](#), [EDA<port>:PDID](#), [XDID](#)

DIDE

eDID editing End

Class EDID and DDC control

Description Marks the end of an EDID editing session.

Command syntax DIDE

Example

```
DIDL myedid7      // loads the EDID file named myedid7
DIDB              // begins an edid editing session
XDID 19 A E88A82A0564796240F48 // edits EDID at 19 for 10 (0x0A) bytes
DIDE              // ends an edid editing session
DIDA myedid8     // saves the changes to the filename myedid8
```

Related commands [DIDA](#), [DIDB](#), [DIDK](#), [DIDL](#), [TASK?](#), [DIDP](#), [DIDQ](#), [DIDS](#), [DIDU](#), [EDA<port>:GDID](#), [EDA<port>:PDID](#), [XDID](#)

DIDK

eDID Kill file

Class EDID and DDC control

Description Deletes the EDID file specified by *filename*.

Command syntax DIDK *path/filename*

path/filename

The directory path and valid MS-DOS filename (8 characters minus any extension) of the file to be deleted. If the file to be deleted is in the default path, then *path/* may be omitted.

Example This example deletes the file *myedid1* in the */userdata* directory on the generator.

```
DIDK /tffs0/library/userdata/myedid1
```

Related commands [DIDA](#), [DIDB](#), [DIDE](#), [DIDL](#), [TASK?](#), [DIDP](#), [DIDQ](#), [DIDS](#), [DIDU](#), [EDA<port>:GDID](#), [EDA<port>:PDID](#), [XDID](#)

DIDL

eDID Load from file

Class EDID and DDC control

Description Loads an EDID from a file on the generator.

Command syntax DIDL *path/filename*
path/filename

The directory path and valid MS-DOS filename (8 characters minus any extension) of the file to be loaded. If the file to be loaded is in the default path, then *path/* may be omitted.

Query syntax DIDL?

Query response The name of the file currently in the buffer.

Example This example loads the EDID from the file *myedid1* in the */userdata* directory.

```
DIDL /tffs0/library/userdata/myedid1
```

Related commands [DIDA](#), [DIDB](#), [DIDE](#), [DIDK](#), [TASK?](#), [DIDP](#), [DIDQ](#), [DIDS](#), [DIDU](#), [EDA<port>:GDID](#), [EDA<port>:PDID](#), [XDID](#)

DIDN

eDID New file

Class EDID and DDC control

Description Creates a new EDID file with the name specified by *filename*.

Command syntax DIDN *path/filename*

path/filename

The directory path and valid MS-DOS filename (8 characters minus any extension) of the file to be created. If the file is to be created in the default path, then *path/* may be omitted.

Example This example creates the file *myedid1* in the */userdata* directory on the generator.

```
DIDN /tffs0/library/userdata/myedid1
```

Related commands [DIDA](#), [DIDB](#), [DIDE](#), [DIDK](#), [DIDL](#), [DIDP](#), [DIDQ](#), [DIDS](#), [DIDU](#), [EDA<port>:GDID](#), [EDA<port>:PDID](#), [XDID](#)

DIDP

eDID Path

Class EDID and DDC control

Description Sets the default EDID path.

Command syntax DIDP *path*
path
path to directory containing EDID files

Example This example sets the default path to the */userdata* directory.

```
DIDP /tffs0/library/userdata
```

Related commands [DIDA](#), [DIDB](#), [DIDE](#), [DIDK](#), [DIDL](#), [TASK?](#), [DIDQ](#), [DIDS](#), [DIDU](#), [EDA<port>:GDID](#), [EDA<port>:PDID](#), [XDID](#)

DIDQ

eDID file Query

Class	EDID and DDC control
Description	Returns EDID filenames from the list of all the EDID filenames stored on the generator, beginning at <i>startIndex</i> and ending at <i>endIndex</i> . The filenames are kept in alphanumeric order.
Query syntax	DIDQ? <i>startIndex</i> <i>endIndex</i> <i>startIndex</i> positive integer number <i>endIndex</i> positive integer number
Query response	List of filenames.
Example	This example returns the first 10 EDID filenames.in the default directory. DIDQ? 1 10
Related commands	DIDA , DIDB , DIDE , DIDK , DIDL , TASK? , DIDP , DIDS , DIDU , EDA<port>:GDID , EDA<port>:PDID , XDID

DIDS

eDID Save to file

Class EDID and DDC control

Description Saves an EDID to the filename given by DIDN.

Command syntax DIDS

Example This example loads an EDID file, edits it, and saves the changes to the same filename.

```
DIDL myedid7      // loads the EDID file named myedid7
DIDB             // begins an edid editing session
XDID 19 A E88A82A0564796240F48 // edits EDID at 19 for 10 (0x0A) bytes
DIDE            // ends an edid editing session
DIDS            // saves the changes to myedid7
```

Related commands [DIDA](#), [DIDB](#), [DIDE](#), [DIDK](#), [DIDL](#), [TASK?](#), [DIDP](#), [DIDQ](#), [DIDU](#), [EDA<port>:GDID](#), [EDA<port>:PDID](#), [XDID](#)

DIDU

eDID Use

Class	EDID and DDC control
Description	Updates hardware with current EDID contents. This command also causes a hot plug pulse on the hot plug detect lead.
Command syntax	DIDU
Query syntax	DIDU?
Query response	The current EDID file in use.
Example	This example edits part of an EDID and updates the hardware with the current buffer contents. XDID 8 3 DE33FF DIDU
Related commands	DIDA , DIDB , DIDE , DIDK , DIDL , TASK? , DIDP , DIDQ , DIDS , EDA<port>:GDID , EDA<port>:PDID , XDID

DIRA

DIRectory save As

Class Directory memory management

Description Saves the current contents of the directory edit buffer using the given name.

Command syntax DIRA *name*

name

a valid MS-DOS filename (8 characters minus any extension)

Example

```
DIRN Vesal      // creates a catalog named Vesal
DIRT Source     // identifies new catalog as a source catalog
DIRB           // begins a directory editing session
NAMI 1 /tffs0/Library/Formats/DMT0660 // adds DMT0660 to catalog
.
.              // add other formats
.
NAMI 6 /tffs0/Library/Formats/DMT0860 // adds DMT0860 to catalog
DIRE           // ends the directory editing session
DIRA Vesal     // saves the catalog
```

DIRB

DIRectory editing Begin

Class	Directory memory management
Description	Marks the beginning of a directory editing session. This command does nothing in the current firmware version, but is used for compatibility with future versions of firmware.
Command syntax	DIRB
Other required commands	Use either a DIRL command to load an existing directory or a DIRN command to create a new directory. Use DIRE when ending the editing session.
Example	<pre>DIRN // Initialize directory edit buffer DIRB // Start directory editing session // One or more directory editing commands ... DIRE // End directory editing session</pre>

DIRE

DIRectory editing End

Class	Directory memory management
Description	Marks the end of a directory editing session. This command does nothing in the current firmware version, but is used for compatibility with future versions of firmware.
Command syntax	DIRE
Other required commands	Use DIRB when starting the editing session. Use DIRS to save changes.
Example	<pre>DIRB // Start directory editing session // One or more directory editing commands ... DIRA MYDIR_02 // Save edited directory as MYDIR_02 DIRE // End directory editing session</pre>

DIRK

DIRectory Kill

Class Directory memory management

Description Deletes a directory by name. The query returns a one if the named directory can be deleted. If directory is read-only or nonexistent, the query returns a zero.

Command syntax DIRK *name*
name
a valid MS-DOS filename (8 characters minus any extension)

Query syntax DIRK? *name*
name
a valid MS-DOS filename (8 characters minus any extension)

Query response 0 or 1

Example DIRK MY_DIR // Delete directory called "MY_DIR"

DIRL

DIRectory Load

Class Directory memory management

Description Copies the directory having a name equal to *name* from directory memory into the directory edit buffer. The query returns a one if the named directory can be loaded; otherwise, a zero is returned.

Note: Use the *FMTP*, *IMGF* and *SEQP* commands to select which directory is used for the format, image, and sequence selection lists.

Command syntax DIRL *name*
name
a valid MS-DOS filename (8 characters minus any extension)

Query syntax DIRL? *name*
name
a valid MS-DOS filename (8 characters minus any extension)

Query response 0 or 1

Example DIRL MY_DIR // Load "MY_DIR" directory in edit buffer

DIRN

DIRectory New

Class Directory memory management

Description Initializes the directory edit buffer. The name *name* is assigned as the directory's name. The query will return the name that has been assigned as the directory's name.

Command syntax DIRN *name*
name
optional valid MS-DOS filename (8 characters minus any extension)

Query syntax DIRN?

Example DIRN // Init edit buffer without assigning a new name
or
DIRN MY_DIR // Init edit buffer with name of "MY_DIR"

DIRP

DIRectory Path

Class Directory memory management

Description Sets the current directory path name. The query will return the current directory path name.

Command syntax DIRP *name*
name
a valid MS-DOS filename (8 characters minus any extension)

Query syntax DIRP?

Query response *name*

Example DIRP DIRPTH01 // Set directory path to DIRPTH01

DIRQ?

DIRectory Query pointer

Class	Directory memory management
Description	Returns the number directory names from the list of all the directory names stored in directory memory beginning at index. The directories are kept in alphanumeric order.
Query syntax	<i>DIRQ? index number</i> <i>index</i> positive integer number <i>number</i> positive integer number
Query response	List of specified directory names
Example	<code>DIRQ? 1 5 // List the first five directories in memory</code> or <code>DIRQ? 1 9999 // List all directories in memory</code>

DIRS

DIRectory Save

Class Directory memory management

Description Saves the current directory edit buffer contents into directory memory using the current name of the directory in the edit buffer.

Example

```
DIRN NTSCFMT      // creates a catalog named NTSCFMT
DIRT Source       // identifies new catalog as a source catalog
DIRB              // begins a directory editing session
NAMI 1 /tffs0/Library/Formats/NTSC // adds NTSC to catalog
DIRE             // ends the directory editing session
DIRS             // saves the catalog
```

DIRT

DIRectory Type

Class Directory memory management

Description Specifies a directory (catalog) type that is being created.

Command syntax DIRT *type*

Command response *type*
Directory type such as: Source, SourceLib, Content, ContentLib

Query syntax DIRT?

Query response *type*
The current directory type defined such as: Source, SourceLib, Content, ContentLib

Example

```
DIRN NTSCFMT      // creates a catalog named NTSCFMT
DIRT Source       // identifies new catalog as a source catalog
DIRB              // begins a directory editing session
NAMI 1 /tffs0/Library/Formats/NTSC // adds NTSC to catalog
.
.                // add other formats
.
NAMI 6 /tffs0/Library/Formats/NTSC-J // adds NTSC-J to catalog
DIRE              // ends the directory editing session
DIRS              // saves the catalog
```

DIRU

DIRectory Use

Class Directory memory management

Description Uses (installs) the currently loaded directory (library).

Command syntax DIRU *directory*

Command response Not applicable

Related commands DIRL

Example

```
DIRN NTSCFMT      // creates a catalog named NTSCFMT
DIRT Source       // identifies new catalog as a source catalog
DIRB              // begins a directory editing session
NAMI 1 /tffs0/Library/Formats/NTSC      // adds NTSC to catalog
DIRE             // ends the directory editing session
DIRS /tffs0/Library/FormatLib/NTSCFMT   // saves the catalog
DIRL /tffs0/Library/FormatLib/NTSCFMT   // loads the catalog
DIRU             // installs the catalog
```

DNUM

Display sequence step NUMbers

Class	Sequence editor commands
Description	Enables and disables the addition of the sequence step number to the displayed test image when running a sequence.
Command syntax	DNUM <i>mode</i> <i>mode</i> 0, 1 or 2
Query syntax	DNUM?
Query response	<i>mode</i>
Example	DNUM 1 // Enable the displaying of the sequence step #

DPGU

Data Island Packet Generator Use

Class [Data Island Packet](#)

Description Updates the hardware with content of the current Data Island packet.

Command syntax DPGU

Related Commands [DPTG](#)

Example 1 Turn mute on:

```
XGCP 1 0
DPTG 7
DPTR 1
DPGU
```

Example 2 Read mute status:

```
R:MUTE?
R:1
```

Example 3 Turn mute off:

```
XGCP 0 1
DPTG 7
DPTR 1
DPGU
```

Example 4 Read mute status:

```
R:MUTE?
R:0
```

Example 5 Change the N value to 6000, and let hardware determine CTS value:

```
XACR 6000
DTPG 7
DPGU
// You can read N and CTS value at the reciever for verification.
```

Example 6 Change the N value to 6000, and CTS to 8000:

```
XACR 6000 8000
DTPG 7
DPGU
// You can read N and CTS value at the reciever for verification.
```

Example 7 Turn audio off:

```
DPTG 3  
DPGU
```

Example 8 Turn audio on:

```
DPTG 7  
DPGU
```

DPTG

Data Island Packet Type Gate

Class [Data Island Packet](#)

Description Gates on or off the assigned packet type (Audio Sample, Audio Clock Regeneration, or General Control Packet) to be updated by the hardware and sent to the receiver.

Gating Audio Sample packets on and off also enables and disables the audio output from the transmitter. The mask value is a value ORed with the current setting.

Command syntax `DPTG mask`

mask

- 1 = General Control Packet (GCP)
- 2 = Audio Clock Regeneration (ACR)
- 4 = Audio Sample
- 8 = Generic Data Packet (GDP)

Related commands [DPGU](#), [DPTR](#)

Example This example gates off the audio (the current value is 7):

`DPTG 3`; [DPGU](#)

See [DPGU](#) for other examples.

DPTR

Data Island Packet Type Repeat Mask

Class [Data Island Packetr](#)

Description Specifies if a General Control packet is sent with every frame or sent once.

Note: *Audio Sample and ACR packets are always enabled (and thus cannot be changed).*

Command syntax DPTR *mask*

mask

1 = General Control Packet (GCP)

8 = Generic Data Packet (GDP)

Example See [DPGU](#) for examples.

DSCT

Digital Sync Composite Type

Class	Format parameter setting - Digital video signal
Description	Establishes the type of composite sync that appears at the digital composite sync outputs when digital composite sync is selected via the SSST command. The DSCT? query returns the current setting of DSCT. A setting of zero (0) indicates that digital composite sync cannot be activated by the operator.
Command syntax	DSCT <i>type</i> <i>type</i> 0 = none 2 = American HDTV w/serrations & equalization 3 = American HDTV w/serrations 4 = American HDTV w/double serrations 5 = Australian AS 493.1-200X CS serrations 6 = European HDTV ORed 7 = European HDTV w/single serrations 8 = European HDTV w/double serrations
Query syntax	DSCT?
Query response	<i>type</i>
Other required commands	The FMTU command instructs the generator to use the new setting. The ALLU command updates hardware to the new setting and redraws the test image.
Example	<pre>DSCT 2 // Select simple Amer ORed in buffer FMTU // Update hardware to current buffer contents</pre>

DSST

Digital Sync Separate Type

Class	Format parameter setting - Digital video signal
Description	<p>Establishes the type of digital separate sync that appears at the digital HS and VS outputs of the generator when digital composite sync is selected via the SSST command and the outputs are gated on via the HSPG and VSPG commands. The only difference between EIA and CCIR digital separate syncs is that, in the case of CCIR, the width of the vertical sync pulse is 0.5 line shorter than the width specified via the VSPW command. In the EIA case, the width of the vertical sync pulse is as programmed.</p> <p>After sending the DSST command, send the FMTU or ALLU command.</p>
Command syntax	<p>DSST <i>type</i></p> <p><i>type</i></p> <ul style="list-style-type: none">0 = none1 = American separate2 = American HDTV separate3 = European HDTV separate4 = Japanese HDTV separate5 = European separate
Query syntax	DSST?
Query response	Returns the current setting of DSST. A setting of zero (0) indicates that separate digital H&V sync cannot be activated by the operator.
Example	<pre>DSST 1 FMTU // Update hardware to current buffer contents</pre>

DVIC

Digital Video Identification Code

Class [InfoFrame Packet](#)

Description Writes the specified Video Identification Code (VIC) into the AVI InfoFrame.

Command syntax DVIC *code*

code

0 = unestablished format

1 - 34 = DVIC code corresponding to a format defined in EIA/CEA-861-C standard (Section 4). See table below for DVIC codes.

For detailed information on these timings refer to the CEA-861-C specification.

DVIC	Format Name	NCPP ¹	HRES ²	VTOT ³
1	DMT0659	1	640	525
1	DMT0660	1	640	525
2	480p59	1	720	525
2	480p60	1	720	525
2	480p59LH	1	720	525
2	480p60LH	1	720	525
3	480p59SH	1	720	525
3	480p60SH	1	720	525
4	720p59	1	1280	750
4	720p60	1	1280	750
5	1080i29	1	1920	1125
5	1080i30	1	1920	1125
6	480i2x29	2	720	525
6	480i2x30	2	720	525
6	480i2xL1	2	720	525
6	480i2xL2	2	720	525
7	480i2xS1	2	720	525
7	480i2xS2	2	720	525
8	240p2x_1	2	720	262
8	240p2x_2	2	720	262
8	240p2x_3	2	720	263
8	240p2x_4	2	720	263
8	240p2xL1	2	720	262
8	240p2xL2	2	720	262
8	240p2xL3	2	720	263
8	240p2xL4	2	720	263
9	240p2xS1	2	720	262

DVIC	Format Name	NCPP¹	HRES²	VTOT³
9	240p2xS2	2	720	262
9	240p2xS3	2	720	263
9	240p2xS4	2	720	263
10	480i4x29	1	2880	525
10	480i4x30	1	2880	525
10	480i4xL1	1	2880	525
10	480i4xL2	1	2880	525
11	480i4xS1	1	2880	525
11	480i4xS2	1	2880	525
12	240p4x_1	1	2880	262
12	240p4x_2	1	2880	262
12	240p4x_3	1	2880	263
12	240p4x_4	1	2880	263
12	240p4xL1	1	2880	262
12	240p4xL2	1	2880	262
12	240p4xL3	1	2880	263
12	240p4xL4	1	2880	263
13	240p4xS1	1	2880	262
13	240p4xS2	1	2880	262
13	240p4xS3	1	2880	263
13	240p4xS4	1	2880	263
14	480p2x59	2	720	525
14	480p2x60	2	720	525
14	480p2xL1	2	720	525
14	480p2xL2	2	720	525
15	480p2xS1	2	720	525
15	480p2xS2	2	720	525
16	1080p59	1	1920	1125
16	1080p60	1	1920	1125
17	576p50	1	720	625
17	576p50LH	1	720	625
18	576p50SH	1	720	625
19	720p50	1	720	750
20	1080i25	1	1920	1125
21	576i2x25	2	720	625
21	576i2xLH	2	720	625
22	576i2xSH	2	720	625
23	288p2x_1	2	720	312
23	288p2x_2	2	720	313
23	288p2x_3	2	720	314
23	288p2xL1	2	720	312
23	288p2xL2	2	720	313
23	288p2xL3	2	720	314
24	288p2xS1	2	720	312

DVIC	Format Name	NCPP¹	HRES²	VTOT³
24	288p2xS2	2	720	313
24	288p2xS3	2	720	314
25	576i4x25	1	2880	625
25	576i4xLH	1	2880	625
26	576i4xSH	1	2880	625
27	288p4x_1	1	2880	312
27	288p4x_2	1	2880	313
27	288p4x_3	1	2880	314
27	288p4xL1	1	2880	312
27	288p4xL2	1	2880	313
27	288p4xL3	1	2880	314
28	288p4xS1	1	2880	312
28	288p4xS2	1	2880	313
28	288p4xS3	1	2880	314
29	576p2x50	1	720	625
29	576p2xLH	1	720	625
30	576p2xSH	1	720	625
31	1080p50	1	1920	1125
32	1080p23	1	1920	1125
32	1080p24	1	1920	1125
33	1080p25	1	1920	1125
34	1080p29	1	1920	1125
34	1080p30	1	1920	1125
35	480p4x59	1	2880	525
35	480p4xL1	1	2880	525
35	480p4x60	1	2880	525
35	480p4xL2	1	2880	525
36	480p4xL2	1	2880	525
36	480p4xS2	1	2880	525
37	576p4x50	1	2880	625
37	576p4xLH	1	2880	625
38	576p4xSH	1	2880	625
39	1080i25_	1	1920	1250
40	1080i50	1	1920	1125
41	720p100	1	1280	750
42	576p100	1	720	625
42	576p100L	1	720	625
43	576p100S	1	720	625
44	576i2x50	2	720	625
44	576i2xL1	2	720	625
45	576i2xS1	2	720	625
46	1080i59	1	1920	1125
46	1080i60	1	1920	1125
47	720p119	1	1280	750

DVIC	Format Name	NCPPI ¹	HRES ²	VTOT ³
47	720p120	1	1280	750
48	480p119	1	720	525
48	480p119L	1	720	525
48	480p120	1	720	525
48	480p120L	1	720	525
49	480p119S	1	720	525
49	480p120S	1	720	525
50	480i2x59	2	720	525
50	480i2x60	2	720	525
50	480i2xL3	2	720	525
50	480i2xL4	2	720	525
51	480i2xS3	2	720	525
51	480i2xS4	2	720	525
52	576p200	1	720	625
52	576p200L	1	720	625
53	576p200S	1	720	625
54	576i2x_1	2	720	625
54	576i2xL2	2	720	625
55	576i2xS2	2	720	625
56	480p239	1	720	525
56	480p239L	1	720	525
56	480p240	1	720	525
56	480p240L	1	720	525
57	480p239S	1	720	525
57	480p240S	1	720	525
58	480i2x_1	2	720	525
58	480i2x_2	2	720	525
58	480i2xL5	2	720	525
58	480i2xL6	2	720	525
59	480i2xS5	2	720	525
59	480i2xS6	2	720	525

1. The generator treats double-clocking and pixel repetition as two totally separate items. NCPPI controls the number of clocks per pixel, while NPPP controls pixel repetition factor. All library formats set pixel repetition factor NPPP to zero (i.e. OFF) by default. Double-clocking and pixel repetition cannot be applied simultaneously due to AVI:RP field constraints. Therefore, double-clocked formats do not support pixel repetition. Pixel repetition is only applicable to the "4x" formats, where HRES remains at 2880-pixels as the pixel repetition factor NPPP is varied between 1 and 10 - thereby varying the effective resolution.
2. Double-clocked formats have the same horizontal resolution as single-clocked formats - the horizontal active (as we define it), is not doubled in the double-clocked case. Some formats are distinguished by a horizontal active that is 4-times the normal value of 720. Here, pixel repetition may be applied, by a special "PixelRep" test image, after the format has loaded. The "PixelRep" test image allows the number of pixels-per-pixel (NPPP) to be varied and an image with repeated pixels to be rendered for test purposes.
3. Some formats are distinguished by having a slightly different vertical line total.

Related commands [XAVI](#) (see VIC parameter),

Example DVIC 23
FMTU

DVPT

Digital Video Protocol Type

Class Format parameter setting - Digital video signal

Description Controls the output protocol. Setting the DVPT parameter to 2 and issuing a FMTU (or ALLU) command causes the output signal protocol to switch to HDMI, while setting DVPT to 1 causes a DVI compatible protocol to be output. All of the formats in the format library set DVPT to 0. This is a default setting, which lets the output protocol be determined, on a global basis, by the type of hardware that is present.

Command syntax DVPT *type*

type

0 = default (based on hardware present)

1 = DVI 1.0

2 = HDMI 1.0

Example DVPT 2
FMTU

DVQM

Digital Video Quantization Mode

Class Format parameter setting - Digital video signal

Description Controls the range of digital signals per the EIA/CEA-861-C standard.
The DVQM? query returns the current DVQM mode.

Command syntax DVQM *mode*

mode

Use the following table to determine the proper mode (0, 1, or 2).

DVQ Mode	Components	NBPC=8 ranges		NBPC=10 ranges		NBPC=12 ranges	
		LMIN	LMAX	LMIN	LMAX	LMIN	LMAX
0	RGB	0	255	0	1023	0	4095
	YCbCr	0	255	0	1023	0	4095
1	RGB	1	254	4	1019	16	4079
	YCbCr	1	254	4	1019	16	4079
2	RGB	16	235	64	940	256	3760
	YCbCr	16	240	64	960	256	3840

Notes:

- Computer (for example, DMT and CVT) formats set DVQM=0 for full range.
- DVQM can be set to 1 to test the undershoot/overshoot signal code margins (for example, see SMPTE 296M section 7.12).
- Television formats (for example, 1080i29) set DVQM=2 for reduced range required by various television standards (for example, EIA/CEA-861-C).

Query syntax DVQM?

Example DVQM 1 // Sets the quantizing mode to 1.
FMTU // Applies the format change

Related commands [LMIN](#), [LMAX](#), [NBPC](#)

DVSC

Digital Video Swing Calibration factor

Class System calibration setting

Description Sets the TMDS differential swing calibration factor for the digital video signal (HDMI and DVI). The DVSC query returns the current value.

Command syntax DVSC *factor*
factor
0.0 to 1.1

Query syntax DVSC?

Related commands [DVSS \(OUT1:DVSS, OUT2:DVSS\)](#)

Examples DVSC 0.9 // sets the digital video swing calibration to 0.9
ALLU

DVSM

Digital Video Sampling Mode

Class Format parameter setting - Digital video signal

Description Controls how the color difference components (CbCr) are sampled when YCbCr signal type is selected. Set DVST to a signal type that supports the sampling mode specified by DVSM.

Command syntax DVSM *mode*

mode

0 = RGB 4:4:4 (default)

2 = 4:2:2 (color difference components are sampled at half the pixel rate; luminance is sampled at full pixel rate)

4 = 4:4:4 (both luminance and color difference components are sampled at the pixel rate)

Related commands [NBPC](#), [DVST](#)

Examples DVST 10 // Selects RGB digital video type
DVSM 0 // Specifies default condition
FMTU // Applies the format change

DVST 14 // Selects YCbCr digital video type
DVSM 2 // Specifies 4:2:2 sampling mode
FMTU // Applies the format change

DVSP

Digital Video Signal Polarity

Class	Format parameter setting - Digital video signal
Description	Establishes the logic sense of the digital video outputs. The DVSP? query returns the current setting of DVSP.
Command syntax	DVSP <i>polarity</i> <i>polarity</i> 0 = active-low (negative going video) 1 = active-high (positive going video)
Query syntax	DVSP?
Query response	<i>polarity</i>
Other required commands	To use the digital video outputs, digital video must be enabled with the DVST command. The FMTU command instructs the generator to use the new setting. The ALLU command updates hardware to the new setting and redraws the test image.
Example	<pre>AVST 0 // Deselect analog video in buffer DVST 5 // Select 3 bit color in buffer DVSP 1 // Select active high video in buffer FMTU // Update hardware to current buffer contents DVSS 1.25 // set digital video swing to 1.25 volts on HDMI output 1 ALLU</pre>

DVSS (OUT1:DVSS, OUT2:DVSS)

Digital Video Signal Swing

Class Format parameter setting - Digital video signal

Description Sets the TMDS differential swing voltage for the digital video signal. For generators with two HDMI ports, the OUT1:DVSS or OUT2:DVSS syntax sets the voltage for the corresponding connector. The DVSS query returns the current value.

The [DV_Swing](#) image can also be used to adjust the digital swing.

Command syntax *connector:DVSS voltage*

connector

OUT1, OUT2 = HDMI OUT 1 or HDMI OUT 2 connector

voltage

0.0 to 2.0 volts differential peak-to-peak (nominally 1.000, 0.150 to 1.560 range guaranteed)

Query syntax OUT1:DVSS?

or

DVSS?

Related commands [DVST](#), [DVSC](#)

Example 1 DVSS 1.25 // sets the digital video signal swing voltage to 1.25 volts on HDMI output 1
ALLU

Example 2 OUT1:DVSS 1.00 // sets the digital video signal swing voltage to 1.0 volts on HDMI output 1
ALLU

Example 3 OUT2:DVSS 0.50 // sets the digital video signal swing voltage to 0.5 volts on HDMI output 2
ALLU

Example 4 OUT2:DVSS? // queries the current value of HDMI output 2
+0.500E+00
ALLU

DVST

Digital Video Signal Type

Class Format parameter setting - Digital video signal

Description Establishes the kind of video signal that exits the digital video signal outputs of the generator.

The DVST? query returns the current setting of DVST.

Command syntax DVST *type*

type

0 = none

9 = YYY follows the sRGB (per ITU-R BT.709)

10 = RGB

13 = YCbCr (per SMPTE 260M-1999, Table 1)

14 = YCbCr (per ITU-R BT.601-5 Table 3, Item 7)

15 = YCbCr (per ITU-R BT.709-5 Part 1, Section 6.10)

16 = Reserved

17 = xvYCC ITU-R BT.601 HDTV

18 = xvYCC ITU-R BT.709 HDTV

Query syntax DVST?

Related commands [AVST](#) must be set to zero when digital video is used. Use the [ALLU](#) or [FMTU](#) command, after the DVST command, to update the hardware with the new settings.

Example

```
AVST 0 // Deselect analog video in buffer
DVST 10 // Select digital RGB
FMTU // Update hardware to current buffer contents
```

DWEL

slider image DWELI time

Class Image Control – System Level

Description Sets the how long each step of the SlideG and SlideRGB built-in images is displayed before the image is updated. The delay is based on the number of vertical frame refreshes that must occur for the currently loaded video format. The command is also used to set how long each step of the Regulate image is displayed. The DWEL? query returns the current DWELL setting.

Command syntax `DWEL delay`
`delay`
integer representing number of video frames

Query syntax `DWEL?`

Query response `delay`

Example `DELX 8 // Set H shift to 8 pixels per step`
`DELY 3 // Set V shift to 3 pixels per step`
`DWEL 2 // Display each step for 2 frames`
`IMGL "SlideG" // Select Image that uses DELX and DELY`
`IMGU // Draw the Image`

EDA<port>:GDID

Get EDID from device

Class EDID and DDC control

Description Reads an EDID from a device connected to the specified HDMI out port. Requires firmware release 2.3.0 or higher.

Command syntax EDA`port`:GDID

port

1 = HDMI out port 1

2 = HDMI out port 2

Example This example reads an EDID from the device connected to HDMI out port 1.

```
EDA1 : GDID
```

Related commands [DIDA](#), [DIDB](#), [DIDE](#), [DIDK](#), [DIDL](#), [TASK?](#), [DIDP](#), [DIDQ](#), [DIDS](#), [DIDU](#), [EDA<port>:PDID](#), [XDID](#)

EDA<port>:PDID

Put EDID to Device

Class EDID and DDC control

Description Writes current EDID to a device connected to the specified HDMI out port. Requires firmware release 2.3.0 or higher.

Command syntax EDA $port$:PDID

port

1 = HDMI out port 1

2 = HDMI out port 2

Example This example writes an EDID to the device connected to HDMI out port 1.

```
EDA1:PDID
```

Related commands [DIDA](#), [DIDB](#), [DIDE](#), [DIDK](#), [DIDL](#), [TASK?](#), [DIDP](#), [DIDQ](#), [DIDS](#), [DIDU](#), [EDA<port>:PDID](#), [XDID](#)

EDE<port>:DIDU

EDID Use

Class EDID and DDC control

Description Updates hardware with current EDID contents. Requires firmware release 2.3.0 or higher.

Command syntax EDE`port`:DIDU

port

the HDMI IN port (1 or 2) to be configured with the contents of the EDID buffer

Query syntax EDE`port`:DIDU?

port

the HDMI IN port (1 or 2) to be read

Example This example edits part of an EDID and updates the HDMI IN port 1 with the current buffer contents.

```
XDID 8 3 DE33FF
EDE1:DIDU
```

Related commands [DIDA](#), [DIDB](#), [DIDE](#), [DIDK](#), [DIDL](#), [TASK?](#), [DIDP](#), [DIDQ](#), [DIDS](#), [DIDU](#), [EDA<port>:GDID](#), [XDID](#)

EDID?

EDID read

Class	EDID and DDC control
Description	Reads all bytes in the base EDID and up to seven extensions from a DDC compliant display connected to the transmitter on the generator. The data is returned in raw ASCII hex format.
Query syntax	EDID?
Query response	ASCII hex test string
Related commands	I2CR? (OUT1:I2CR? , OUT2:I2CR? , VGA:I2CR?)

Example This example reads a four block E-EDID.

```
R:\edid?  
00FFFFFFFFFFFF004489B200050000000D0C010380502D780A0DC9A05747982712484C200  
000010101010101010101010101010101010101010101010101011D8018711C1620582C2500C48E2100009E8C  
0AD08A20E02D10103E9600138E21000018000000FC0048444D492054560A2020202020000  
000FD003B3D0F2E08000A2020202020200306F0020200000000000000000000000000000  
000000000000000000000000000000000000000000000000000000000000000000000000  
000000000000000000000000000000000000000000000000000000000000000000000000  
000000000000000000000000000000000000000000000000000000000000000000000000  
C02031CF149850408020106141216230907078301000065030C001000011D007251D01E20  
6E285500C48E2100001ED60980A020E02D1010602200128E210000188C0AD090204031200  
C405500C48E21000018011D80D0721C1620102C2580C48E2100009E8C0AA01451F0160026  
7C4300138E210000980000000000000000000000A4020308F1431113158C0AD090204031200C4  
05500138E21000018011D00BC52D01E20B8285540C48E2100001E8C0AA02051201810187E  
2300C48E210000980000000000000000000000000000000000000000000000000000000000  
000000000000000000000000000000000000000000000000000000000000000000000000  
71
```

ENET

Reads EtherNET address

Class Tools

Description Retrieves the Ethernet (MAC) address of the generator.

Query syntax ENET?

Query response ASCII hex test string

Related commands None

Example ENET?
00:07:AA:00:20:00

ENET:IP

Sets IP address for EtherNET port

Class	Tools
Description	Sets the IP address of the Ethernet port of the generator.
Command syntax	ENET:IP <i>IP</i> <i>IP</i> in the format: www.xxx.yyy.zzz
Query syntax	ENET:IP?
Query response	IP address in format: www.xxx.yyy.zzz
Related commands	None
Example	ENET:IP 192.168.254.222

ENET:MASK

Sets IP address subnet MASK for EtherNET port

Class	Tools
Description	Sets the IP address of the Ethernet port of the generator.
Command syntax	ENET:MASK <i>mask</i> <i>mask</i> in the format: www.xxx.yyy.zzz
Query syntax	ENET:MASK?
Query response	subnet mask in format: www.xxx.yyy.zzz
Related commands	None
Example	ENET:MASK 255.255.255.000

EQUA

EQUalization interval After vertical sync pulse

Class	Format parameter setting - synchronization
Description	Establishes the width of the equalization interval after the vertical sync pulse in each field whenever a serrated and equalized sync type is selected via either ASCT or DSCT commands and selected via the SSST command. If the type specified for the selected sync signal is one of the CCIR types, then the actual equalization interval output by the generator will be 0.5 lines shorter than the whole number specified. The EQUA? query returns the current setting of EQUA.
Command syntax	<pre>EQUA <i>lines</i> <i>lines</i> min = 0 max = number of lines after vertical sync before video</pre>
Query syntax	EQUA?
Query response	<i>lines</i>
Other required commands	The FMTU command instructs the generator to use the new setting. The ALLU command updates hardware to the new setting and redraws the test image.
Example	<pre>EQUA 3 // Set post-equalization to 3 lines in buffer FMTU // Update hardware to current buffer contents</pre>

EQUB

EQUalization interval Before vertical sync pulse

Class	Format parameter setting - synchronization
Description	Establishes the width of the equalization interval before the vertical sync pulse in each field whenever a serrated and equalized sync type is selected via either ASCT or DSCT commands and selected via the SSST command. If the type specified for the selected sync signal is one of the CCIR types, then the actual equalization interval output by the generator will be 0.5 lines shorter than the whole number specified. The EQUB? query returns the current setting of EQUB.
Command syntax	<pre>EQUB <i>lines</i> <i>lines</i> min = 0 max = number of lines after video and before vertical sync</pre>
Query syntax	EQUB?
Query response	<i>lines</i>
Other required commands	The FMTU command instructs the generator to use the new setting. The ALLU command updates hardware to the new setting and redraws the test image.
Example	<pre>EQUB 3 // Set pre-equalization to 3 lines in buffer FMTU // Update hardware to current buffer contents</pre>

EQUF

EQUalization Flatten

Class	Format parameter setting - synchronization
Description	Determines if composite sync will have all equalization pulses removed in the vertical sync front porch (delay) period as required by certain military HOB0 and Maverik video formats. The EQUF? query returns the current setting of EQUF.
Command syntax	<code>EQUF mode</code> <i>mode</i> 0 = OFF 1 = ON
Query syntax	<code>EQUF?</code>
Query response	<i>mode</i>
Other required commands	The FMTU command instructs the generator to use the new setting. The ALLU command updates hardware to the new setting and redraws the test image.
Example	<code>EQUF 0; ALLU // This is the default</code>

ERRC

ERRor queue Clear

Class System error control

Description Clears all errors waiting to be reported in the error queue.

Command syntax ERRC

ERRQ?

ERRor Queue

Class	System error control
Description	Returns number errors from the list of all errors in the error queue beginning at index. The ERRQ? query does not remove the errors from the queue.
Command syntax	ERRQ? <i>index number</i> <i>index</i> Positive integer number <i>number</i> Positive integer number
Query response	List of specified range of errors in the error queue.
Examples:	ERRQ? 1 5 // List the first five errors in the queue or ERRQ? 1 9999 // List all errors in the queue

ERRY?

Yank ERRor from queue

Class Format parameter setting - synchronization

Description Returns the most recent error added to the error queue and removes it from the queue.

Query syntax ERY?

Query response Error

EXAR

EXtended Aspect Ratio

Class Format parameter setting - active video

Description Sets the aspect ratio of the extended image content.

Note: *If the source image content was shot for a single screen shape, then this parameter will be the same as the CXAR parameter. Alternatively, if the source image content was shot for two different shaped screens (using a “shoot and protect” technique), then this parameter will be different than the CXAR parameter.*

Command syntax EXAR *aspect_ratio*
aspect_ratio
0.75 to 2.39

Note: *For a listing of established aspect ratios, see the table on page 530 (CXAR command).*

Related commands [CXAR](#), [SXAR](#)

Example EXAR 1.77 // Sets 16:9 picture aspect ratio for extended image content
FMTU

EXCX

Extended-From-Content Aperture Map

Class Format parameter setting - active video

Description Maps CXAR-shaped image content into the extended EXAR-shaped aperture.

Command syntax *EXCX code*

code

0 to 131071 (in decimal)

The mapping code is made up of three binary field codes as follows:

- Bits 0-2 are the *Squeeze/Stretch* (“S”) field code
- Bits 3-9 are the *Letterbox/Pillar* (“L”) field code
- Bits 10-16 are the *Safe Area* (“K”) field code

To determine the proper mapping code, follow these steps:

1. Using the table below, determine the proper “S” field code for bits 0-2.

Squeeze/Stretch Method	“S” Field Code			Symbol
	Undo	Non-Linear	Squeeze	
	Bit 2	Bit 1	Bit 0	
Disabled (scaling is uniform)	0	0	0	
Linear Squeeze (anamorphise)	0	0	1	S

2. Using the table below, determine the proper “L” field code for bits 3-9.

Letterbox/Pillar Mode	“L” Field Code							Symbol
	Undo	Bars	BarContents		Position		Shrink	
	Bit 9	Bit 8	Bit 7 ¹	Bit 6 ¹	Bit 5	Bit 4	Bit 3	
Disabled	0	0	0	0	0	0	0	
Centered shrink w/black bars top & bottom	0	1	0	0	0	0	1	Lcbb
Centered shrink w/gray bars top & bottom	0	1	0	1	0	0	1	Lcgb
Centered shrink w/white bars top & bottom	0	1	1	0	0	0	1	Lcwb
Centered protected shrink w/shot surround	0	0	0	0	0	0	1	Lcsp
Top shrink w/single black bar at bottom	0	1	0	0	0	1	1	Ltbb
Top shrink w/single gray bar at bottom	0	1	0	1	0	1	1	Ltgb
Top shrink w/white bar at bottom	0	1	1	0	0	1	1	Ltwb

1. Bits 6 and 7 are used to sequence redundant AFD codes.

In the case of pixel repetition (NPPP not equal to 0), the color of the (extended) bars on the left and right sides of the image are filled in accordance with the settings of bits 6 and 7—even when the letterbox/pillar fitting method is disabled (bit 3 = 0).

3. Use the following table to determine the proper “K” field code for bits 10-16.

(Keep) Safe Area Mode	“K” Field Code							Symbol
	Undo	Bars	BarContents		Source	Save Area		
	Bit 16	Bit 15	Bit 14	Bit 13	Bit 12	Bit 11	Bit 10	
None (w/safe area markers)	0	0	0	0	0	0	0	
Shrink coded frame to action area with opaque black bar surround	0	1	0	0	0	0	1	Kabb
Shrink coded frame to action area with opaque gray bar surround	0	1	0	1	0	0	1	Kagb
Shrink coded frame to action area with opaque white bar surround	0	1	1	0	0	0	1	Kawb
Coded frame has shot-protected action area without graticules or bars	0	0	0	0	0	0	1	Kasp
Coded frame has shot-protected action area with action graticules without bars	0	0	0	1	0	0	1	Kaspa
Coded frame has shot-protected action area with title graticules without bars	0	0	1	0	0	0	1	Kaspt
Coded frame has shot-protected action area with action and title graticules without bars	0	0	1	1	0	0	1	Kaspb
Shrink coded frame to title area with opaque black bar surround	0	1	0	0	0	1	0	Ktbb
Shrink coded frame to title area with opaque gray bar surround	0	1	0	1	0	1	0	Ktgb

(Keep) Safe Area Mode	“K” Field Code							Symbol
	Undo	Bars	BarContents		Source	Save Area		
	Bit 16	Bit 15	Bit 14	Bit 13	Bit 12	Bit 11	Bit 10	
Shrink coded frame to title area with opaque white bar surround	0	1	1	0	0	1	0	Ktwb
Coded frame has shot-protected title area without graticules or bars	0	0	0	0	0	1	0	Ktsp
Coded frame has shot-protected title area with action graticules without bars	0	0	0	1	0	1	0	Ktspa
Coded frame has shot-protected title area with title graticules without bars	0	0	1	0	0	1	0	Ktspt
Coded frame has shot-protected title area with action and title graticules without bars	0	0	1	1	0	1	0	Ktspb
Coded frame has shot-protected custom area without graticules or border	0	0	0	0	0	1	1	Kcsp
Coded frame has shot-protected custom area with action graticules without border	0	0	0	1	0	1	1	Kcspa
Coded frame has shot-protected custom area with title graticules without border	0	0	1	0	0	1	1	Kcspt

The following table provides mapping codes used by AFD (see [XAFD](#)).

Method	Binary Field Code	Decimal Code	Symbol
Natural aspect ratio	0000000000000000	0	N0
	00000000000010000	16	N1
	00000000000100000	32	N2
Squeeze (anamorphise)	00000000000000001	1	S
Centered protected shrink with shot surround	00000000000001000	8	Lcsp
Centered shrink with black bars top and bottom	00000000100001000	264	Lcbb
Top shrink with single black bar at bottom	00000000100011000	280	Ltbb
Shrink coded frame to title area w/ opaque black bar surround	01000100000000000	34816	Ktbb

Related commands [CXAR](#), [EXAR](#), [SXCX](#), [SXEX](#)

Example EXCX 8 // Use centered protected shrink w/shot surround mode
FMTU

FILE:LOAD

FILE:LOAD

Class	Tools
Description	Loads and uses a file such as an image or format.
Command syntax (flash memory/ PC card)	<code>FILE:LOAD <i>filename</i></code> <i>filename</i> Any file in a generator library directory.
Command syntax (file server)	<code>FILE:LOAD <i>server_name/filename</i></code> <i>server_name</i> Valid hostname (no forward slash before name, and colon after name) <i>filename</i> Any file in a file server library directory.
Related commands	None
Example	<code>FILE:LOAD barsmpte.o // Loads file from generator</code> <code>FILE:LOAD Host1:/barsmpte.o // Loads file from file server "Host1".</code>

FILE:SCREENCAP

FILE:SCREENCAP

Class Tools

Description Captures an image currently rendered on the display to a bit map.

Command syntax FILE:SCREEN *filename.bmp*
filename.bmp

Related commands None

Example FILE:SCREENCAP diamond.bmp

FMTA

ForMaT save As

Class Format memory management

Description Saves the current contents of the format edit buffer using the given name

Command syntax FMTA *name*

name

a valid MS-DOS filename (8 characters minus any extension)

Example FMTA MY_FMT // Save with the name "MY_FMT"

FMTB

ForMaT editing Begin

Class Format editor control

Description Marks the beginning of a format editing session.

Command syntax FMTB

Other required commands Use either an [FMTL](#) command to load an existing image or an [FMTN](#) command to create a new format. Use [FMTE](#) when ending the editing session.

Example

```
FMTN // Initialize format edit buffer
FMTB // Start format editing session

      // One or more format editing commands ...

FMTE // End format editing session
```

FMTE

ForMaT editing End

Class Format editor control

Description Marks the end of a format editing session.

Command syntax FMTE

Other required commands Use [FMTB](#) when starting the editing session. Use [FMTA](#) or [FMTS](#) to save changes.

```
Example FMTB          // Start format editing session

          // One or more format editing commands ...

FMTA My_fmt1 // Save edited format as My_fmt1
FMTE          // End format editing session
```

FMTG?

ForMaT in buffer Good

Class Format memory management

Description Tests the format in the format buffer for errors. If no errors are found, FMTG? returns zero. Otherwise, if one or more errors exist, the number of the first error encountered is returned. To test formats residing in format memory, use the FMTT? query.

Query syntax FMTG?

Query response Returns 0 if no errors are found; otherwise, returns the number of the first error encountered.

Example `FMTG? // Return format error status`

FMTK

ForMaT Kill from memory by name

Class	Format memory management
Description	Erases the named format from memory. The FMTK? query checks to see if the named format can be erased. The RAM location number is returned if it can be erased. Otherwise, a zero is returned.
Command syntax	FMTK <i>name</i> <i>name</i> a valid MS-DOS filename (8 characters minus any extension)
Query syntax	FMTK? <i>name</i> <i>name</i> valid MS-DOS filename (8 characters minus any extension)
Query response	0 or location
Example	FMTK my_fmt1 // Erase format called my_fmt1

FMTL

ForMaT Load from memory by name

Class	Format memory management
Description	<p>Assigns a format to the current step of a sequence while between a set of SEQB and SEQE commands. The FMTL command is context sensitive. The FMTL? query returns the name of the format currently assigned to the step.</p> <p>Outside of the sequence editor, the FMTL command reads the format having a name equal to name from format memory (or EPROM) into the format. FMTL does not reconfigure the signal generating hardware. This feature allows you to work on the contents of any format memory location, while continuing to output a signal based on a previously used format (see FMTU command). The FMTL? query returns the location location in which a format having a name equal to name is found. If multiple formats exist having name <i>name</i>, then the lowest numbered location containing a format with a matching name <i>name</i> is returned. The format memory (RAM) is always searched first. If a format with name <i>name</i> cannot be found anywhere in the format memory, then the industry-standard formats located in EPROM (negative locations) are searched next.</p> <p>The FMTL? query returns zero if a format with a name equal to name cannot be found in either format space.</p>
Command syntax	<p>FMTL <i>name</i></p> <p><i>name</i> a valid MS-DOS filename (8 characters minus any extension)</p>
Query syntax	FMTL? <i>name</i>
Query response	location (returns 0 if not found)
Other required commands	The ALLU command updates the hardware to the new settings and redraws the test image.
Example	<pre>FMTL VGA_m3 // Load format called VGA_m3 ALLU // Update hardware and redraw image</pre>

FMTN

ForMaT New

Class Format memory management

Description Initializes the format editing buffer. Sending this one command is equivalent to sending all of the following commands:

ASBG 0	GAMA 2.2
ASCT 1	GAMC 0
ASGG 1	HRAT 0
ASSG 0, 1, 0	HRES 0
ASSS 0.286	HSIZ 280
AVPG 0	HSPD 0
AVPS 0.0	HSPG 1
AVSB 0.0	HSPP 0
AVSS 0.714	HSPW 0
AVST 0	HTOT 0
XVSG 1, 1, 1	SCAN 1
CSPG 1	SSST 1
CSPP 0	USIZ 2
DCBM 0	VRES 0
DSEX 0	VSIZ 210
DSST 1	VSPD 0
DVSP 0	VSPG 1
DVST 0	VSPP 0
EQUA 0	VSPW 0
EQUB 0	VTOT 0

This should be the first command sent to the generator when creating a new format. The command only resets to a known state. The command does not create a usable format. The FMTN? query returns the current name of the format in the buffer.

Command syntax FMTN *name*
name
a valid MS-DOS filename (8 characters minus any extension)

Query syntax FMTN?

Query response *name*

Example FMTN // Initialize format buffer

or

FMTN Narf // Initialize format buffer and name the format "Narf"

FMTQ?

ForMaT Query pointer

Class Format memory management

Description Returns number format names from the list of all the formats stored in format memory beginning at index. The formats are kept in alphanumeric order. The generator maintains internal variables for the current index and number values. The value of index is automatically incremented by number after the query is executed. Sending the query with just an index parameter returns the same number of names as the last time, starting at the given index. Sending the query with no parameters, returns the next set of names.

Query syntax FMTQ? [*index* [*number*]]

index

positive integer number

number

positive integer number

Query response List of specified format names

Example FMTQ? 1 9999 // List all formats in memory

or

FMTQ? 1 10 // List the first ten formats in memory

FMTQ? 21 10 // List the 21st through the 30th FMTes in memory

FMTQ? 31 1 // List the 31st through the 40th FMTes in memory

FMTS

ForMaT Save

Class Format memory management

Description Saves the current format edit buffer contents into format memory using the current name of the format in the edit buffer.

Command syntax FMTS

Example

```
FMTL DMT0660 // Loads a format for editing
FMTB          // Begins and editing session
HRES 654      // Sets the horizontal resolution to 654 pixels
.
.            // other format parameters
.
HTOT 720     // Sets the horizontal total to 720 pixels
FMTE        // Ends the format editing session
FMTS        // Saves format
```

FMTU

ForMaT Use

Class	Format memory management
Description	<p>Checks the current contents of the format buffer for errors; if no errors are found, it reconfigures the signal generating hardware in accordance with the contents. It does not redraw the previously displayed test image. In some cases this may distort the old image.</p> <p>The FMTU? query returns either a format memory location <i>location</i> or zero. If the signal format currently being output by the signal generating hardware matches that originally loaded (using the FMTL command) from a format memory location, then the matching format memory location <i>location</i> is returned. Otherwise, if the format contents have been used to update the signal generating hardware since either an FMTR or FMTL command has been issued, then FMTU? query returns zero.</p>
Command syntax	FMTU
Query syntax	FMTU?
Query response	location or 0

FMTZ

ForMat Zap

Class Format memory management

Description Clears format storage memory starting at first and ending at last. The cleared locations are then tagged as being empty. If no last parameter is given, only the first location is cleared. The FMTZ? query is used to determine if a location contains a format or is empty.

Command syntax FMTZ *first last*

Query syntax FMTZ? *location*

FORM

draw FORMat data block

Class	Custom image primitive
Description	<p>Displays basic information about the format driving the display. The first line shows the number of horizontal active pixels and vertical active lines. The last number on the line is the number of fields per frame (1 for non-interlaced and 2 for interlaced). The second and third lines show the horizontal and vertical rates, respectively. Text is on a black rectangular background with a single pixel border.</p> <p>FORM uses three (3) parameters. The first is the color of the text and border. The next two are the X and Y coordinates for the top left corner of the block of text.</p>
Command syntax	<pre>FORM <i>color</i> <i>x</i> <i>y</i></pre> <p><i>color</i> available colors</p> <p><i>x</i> positive integer number</p> <p><i>y</i> positive integer number</p>
Other required commands	The FMTU command instructs the generator to use the new setting. The ALLU command updates hardware to the new setting and redraws the test image.
Example	<pre>FORM blue 30 200 // Display format information // in blue beginning at X=30, Y=200 ALLU // Update hardware to current buffer contents</pre>

FRAT?

Frame RATE Query

Class Format parameter setting - Video resolution

Description Returns the current frame (vertical) rate setting.

Query syntax FRAT?

Query response frame rate

Example FRAT?
25.0000

Related commands [TMAU](#)

FRGB

Foreground Red, Green and Blue levels

Class System parameter settings

Description Temporarily sets the portions of an image drawn with a color selection of foreground to the given red, green and blue values. All three colors can be set to the same level using a single parameter. The color selection for one or more primitives in a custom image must be set to foreground in order to see the affect of this command on a custom image. The setting is not global and is not saved. The FRGB? query returns the current red, green and blue settings of FRGB.

Command syntax `FRGB red_level green_level blue_level`

or

`FRGB common_gray_level`

level

min = 0 (full off)

max = 255 (full on)

Example `FRGB 255 128 0 // Set foreground color to orange`

or

`FRGB 128 // Set foreground color to a mid-gray level`

FSPD

Frame Sync Pulse Delay

Class	Format parameter setting - Synchronization
Description	Sets the delay of the frame sync pulse relative to the last line of active video in the current format. The FSPD? query returns the current FSPD setting.
Command syntax	FSPD <i>delay</i> <i>delay</i> min = 0 lines max = (VTOT/SCAN) line
Query syntax	FSPD?
Query response	<i>delay</i>
Other required commands	To get a pulse, frame sync must first be enabled with the FSPG command. The FMTU command instructs the generator to use the new settings. The ALLU command updates the hardware to the new settings and redraws the test image.
Example	<pre>FSPG 1 // Enable Frame Sync FSPD 1 // Set for positive going pulse FSPW 20 // Make the pulse 20 pixels wide FSPG 300 // Pulse to occur 300 lines after // the last line of active video FMTU // Update hardware to new settings</pre>

FSPG

Frame Sync Pulse Gate

Class	Format parameter setting - Synchronization
Description	Enables and disables the digital horizontal sync output. The FSPG? query returns the current FSPG mode.
Command syntax	FSPG <i>mode</i> <i>mode</i> 0 = OFF 1 = ON
Query syntax	FSPG?
Query response	0 or 1
Other required commands	The FMTU command instructs the generator to use the new settings. The ALLU command updates the hardware to the new settings and redraws the test image.
Example	<pre>FSPG 1 // Enable Frame Sync FMTU // Update hardware to new settings</pre>

FSP

Frame Sync Pulse Polarity

Class	Format parameter setting - Synchronization
Description	Establishes the logic sense of the digital frame sync output. Setting polarity to one (1) causes the leading edge of frame sync to be a low-to-high transition. Setting polarity to zero (0) causes the leading edge of frame sync to be a high-to-low transition. The FSPP? query returns the current polarity of FSPP.
Command syntax	<i>FSP</i> <i>polarity</i> <i>polarity</i> 0 = active-low (negative going pulse) 1 = active-high (positive going pulse)
Query syntax	FSPP?
Query response	0 or 1
Other required commands	To get a pulse, frame sync must first be enabled with the FSPG command. The FMTU command instructs the generator to use the new settings. The ALLU command updates the hardware to the new settings and redraws the test image.
Example	<pre>FSPG 1 // Enable Frame Sync FSPP 1 // Set for positive going pulse FSPW 20 // Make the pulse 20 pixels wide FSPG 300 // Pulse to occur 300 lines after // the last line of active video FMTU // Update hardware to new settings</pre>

FSPW

Frame Sync Pulse Width

Class	Format parameter setting - Synchronization
Description	Establishes the width of the frame sync pulse. The FSPW? query returns the current setting of FSPW.
Command syntax	FSPW <i>pixels</i> <i>pixels</i> min = 1 max = HTOT - 1
Query syntax	FSPW?
Query response	<i>pixels</i>
Other required commands	The FMTU command instructs the generator to use the new settings. The ALLU command updates the hardware to the new settings and redraws the test image.
Example	<pre>FSPG 1 // Enable Frame Sync FSPP 1 // Set for positive going pulse FSPW 20 // Make the pulse 20 pixels wide FSPG 300 // Pulse to occur 300 lines after the last line of active video FMTU // Update hardware to new settings</pre>

GAMA

GAMmA correction factor

Class	Format parameter setting - Digital video signal
Description	Establishes the current video gamma correction factor. The GAMA? query returns the current setting of the gamma correction factor.
Command syntax	<i>GAMA factor</i> <i>factor</i> min = 0.1 (floating point accepted) max = 10.0 (floating point accepted) For HDMI video signals GAMA is always 2.222
Query syntax	GAMA?
Query response	<i>factor</i>
Other required commands	Gamma correction must be enabled with the GAMC command in order to use the gamma correction factor. The FMTU command instructs the generator to use the new setting. The ALLU command updates hardware to the new setting and redraws the test image.
Example	<pre>GAMC 1 // Enable gamma correction in buffer GAMA 2.2 // Set correction factor in buffer FMTU // Update hardware to current buffer contents</pre>

GAMC

GAMMa Correction mode

Class	Format parameter setting - Digital video signal
Description	Enables or disables application of the video gamma correction factor. The GAMC? query can be used to determine if the gamma correction factor is currently being applied.
Command syntax	<i>GAMC mode</i> <i>mode</i> 0 = disable (don't correct) 1 = enable (correct)
Query syntax	GAMC?
Query response	0 or 1
Other required commands	The value used for gamma correction is set with the GAMA command. The FMTU command instructs the generator to use the new setting. The ALLU command updates hardware to the new setting and redraws the test image.
Example	<pre>GAMC 1 // Enable gamma correction in buffer GAMA 2.2 // Set correction factor in buffer FMTU // Update hardware to current buffer contents</pre>

GPIB

GPIB address

Class GPIB port control

Description Sets the address of the generator on the GPIB port. The address change takes effect as soon as the command is issued. The new address setting will be maintained until 1) the address is changed another GPIB command, 2) the unit is re-initialized with an [INIT](#) command or 3) the unit is re-initialized because the power-up self-test found corrupted data in battery backed system memory. In cases 2 and 3, the GPIB address will revert to the address set on the GPIB address switches, if the unit has them. The address reverts to 15 if the unit does not have GPIB address switches. The GPIB? query returns the current GPIB address of the unit.

Command syntax GPIB *address*
address
integer, 0-30

Query syntax GPIB?

Query response *address*

Example GPIB 5 // Set GPIB address to 5

GRID

draw a centered GRID

Class	Custom image primitive
Description	Draws a crosshatch of a given color and forms a given number of boxes in each direction. All lines are 1 pixel thick. All of the lines in a given direction are equally spaced. Any remaining pixels are distributed as equally as possible around the perimeter of the grid. This may cause the first and last lines in each direction not to be at the very edges of video.
Command syntax	<pre>GRID <i>color horizontal_boxes vertical_boxes</i> <i>color</i> available colors <i>horizontal_boxes</i> number of horizontal boxes (half of number of pixels) <i>vertical_boxes</i> number of vertical boxes (half of number of lines)</pre>
Other required commands	The FMTU command instructs the generator to use the new settings. The ALLU command updates the hardware to the new settings and redraws the test image.
Example	<pre>GRID gray75 14 10 // Draw a gray75 grid with 14 horizontal // and 10 vertical boxes ALLU // Update hardware to current buffer contents</pre>

GRIH

draw a GRILL pattern of Horizontal lines

Class	Custom image primitive
Description	Draws equally spaced horizontal lines that form a grill over the entire active video area. The primitive uses three parameters. The first is the color of the lines, the second is the thickness of the lines, and the third is the thickness of the space between the lines.
Command syntax	<pre>GRIH <i>color line_width space_width</i></pre> <p><i>color</i> available colors</p> <p><i>line_width</i> number of pixels in line</p> <p><i>space_width</i> number of pixels in space</p>
Other required commands	The FMTU command instructs the generator to use the new settings. The ALLU command updates the hardware to the new settings and redraws the test image.
Example	<pre>GRIH green 4 6 // Draw green grid with 4-pixel lines and 6-pixel spaces ALLU // Update hardware to current buffer contents</pre>

GRIV

draw a GRILL pattern of Vertical lines

Class	Custom image primitive
Description	Draws equally spaced vertical lines that form a grill over the entire active video area. The gaps are not touched and will show any previously drawn primitives. The primitive uses three parameters. The first is the color of the lines, the second is the thickness of the lines, and the third is the thickness of the space between the lines.
Command syntax	<pre>GRIV <i>color line_width space_width</i></pre> <p><i>color</i> available colors</p> <p><i>line_width</i> number of pixels in line</p> <p><i>space_width</i> number of pixels in space</p>
Other required commands	The FMTU command instructs the generator to use the new settings. The ALLU command updates the hardware to the new settings and redraws the test image.
Example	<pre>GRIV cyan 16 16 // Draw cyan grill with 16-pixel lines // and 16-pixel spaces ALLU // Update hardware to current buffer contents</pre>

GRNG

GRNe Gate

Class Video Gate

Description Toggles the green video signal gate.

Command syntax GRNG *mode*
mode
0 = disable
1 = enable

Query syntax GRNG?

Query response 0 or 1

Other required commands [ALLU](#) to invoke the command.

Related commands [BLUG](#), [REDG](#)

Example GRNG 0; ALLU // disable green video component

HATI

draw a centered crossHATch from the Inside out

Class	Custom image primitive
Description	Draws a crosshatch from the inside-out of a given color and forms a given number of boxes in each direction. The primitive has center lines that divide the active video exactly in half in each direction. The vertical center line is 2 pixels thick if the format has an even number of active pixels. The horizontal center line is 2 pixels thick if the format has an even number of active lines. All other lines are 1 pixel thick. If you enter an odd number of boxes, a half box is placed at each end of the crosshatch. All lines in a given direction are spaced equally. Any remaining pixels are distributed as equally as possible around the perimeter of the grid. This may cause the first and last lines in each direction not to be at the very edges of video. In turn, this may cause any half boxes to be slightly larger.
Command syntax	<pre>HATI <i>color horizontal_boxes vertical_boxes</i> <i>color</i> available colors <i>horizontal_boxes</i> number of horizontal boxes (half of number of pixels) <i>vertical_boxes</i> number of vertical boxes (half of number of lines)</pre>
Other required commands	The FMTU command instructs the generator to use the new settings. The ALLU command updates the hardware to the new settings and redraws the test image.
Example	<pre>HATI green 15 9 // Draw a green grid with 15 horizontal // and 9 vertical boxes ALLU // Update hardware to current buffer contents</pre>

HATO

draw a centered crossHATch from the Outside in

Class	Custom image primitive
Description	Draws a crosshatch from the outside-in of a given color and forms a given number of boxes in each direction. All lines are 1 pixel thick. The first and last lines in each direction are at the very edges of active video. All the lines in a given direction are spaced equally. Any remaining pixels are added to the boxes along the horizontal and vertical centers of the image.
Command syntax	<pre>HATO <i>color horizontal_boxes vertical_boxes</i> <i>color</i> available colors <i>horizontal_boxes</i> number of horizontal boxes (half of number of pixels) <i>vertical_boxes</i> number of vertical boxes (half of number of lines)</pre>
Other required commands	The FMTU command instructs the generator to use the new settings. The ALLU command updates the hardware to the new settings and redraws the test image.
Example	<pre>HATO yellow 15 9 // Draw a yellow grid with 15 horizontal // and 9 vertical boxes ALLU // Update hardware to current buffer contents</pre>

HPPW

Hot Plug Pulse Width

Description: The Hot Plug Pulse Width command is used to set the assertion pulse width of the analyzer's hot plug pulse.

Command syntax `HPPW value`
value (milliseconds) in the range of 100 to 4000

Query syntax `HPPW?`

Query response *value*

Other required commands There are no other commands required.

Related commands There are no other related commands.

Example `HPPW 175 // sets the hot plug assertion pulse width to 175ms`
`HPPW? // queries the current value for the hot plug pulse assertion`

HRAT

Horizontal RATE

Class	Format parameter setting - Video resolution
Description	Sets the line frequency. Pixel rate is equal to HTOT multiplied by HRAT. Frame rate is equal to HRAT divided by VTOT. Field rate is equal to SCAN multiplied by the frame rate. The HRAT? query returns the current horizontal frequency setting.
Command syntax	<pre>HRAT <i>frequency</i> <i>frequency</i> typical min = 1000 Hz (floating point accepted) typical max = 130000 Hz (floating point accepted)</pre>
Query syntax	HRAT?
Query response	frequency in Hz (floating point returned)
Other required commands	The FMTU command instructs the generator to use the new settings. The ALLU command updates the hardware to the new settings and redraws the test image.
Example	<pre>HRAT 32768 // Set 32.768 kHz rate in buffer FMTU // Update hardware to current buffer contents or HRAT 32.768E3 // Set a 32.768 kHz rate FMTU // Update hardware to current buffer contents</pre>

HRES

Horizontal RESolution

Class	Format parameter setting - Video resolution
Description	Establishes the number of active pixels per line. The HRES? query returns the current setting of HRES.
Command syntax	HRES <i>pixels</i> <i>pixels</i> min = 16 max depends on VRES and model of generator
Query syntax	HRES?
Query response	<i>pixels</i>
Other required commands	The ALLU command updates hardware to the new setting and redraws the test image.
Example	<pre>HRES 480 // Set 480 active pixels line in buffer ALLU // Configure hardware and redraw image</pre>

HSIZ

Horizontal Size

Class	Format parameter setting - Video resolution
Description	<p>Establishes the horizontal physical size of the image on the display. Units expected (or returned) vary according to the last mode set with USIZ command. The HSIZ command is context sensitive and must appear between begin and end commands FMTB and FMTE. The HSIZ? query returns the current setting of HSIZ.</p> <p>Note: Make sure that the USIZ parameter is properly set before using the HSIZ command. Changing the USIZ setting after entering HSIZ will convert the size to match the new unit of measure.</p>
Command syntax	<p>HSIZ <i>physical_size</i></p> <p><i>physical_size</i></p> <p>positive value (floating point accepted)</p>
Query syntax	HSIZ?
Query response	Returns physical size (floating point returned)
Other required commands	The units of measure must be properly set by USIZ before entering HSIZ. The ALLU command updates hardware to the new setting and redraws the test image, taking the new size into account.
Example	<pre>FMTB // Begin editing session One or more format editing commands // ... USIZ 1 // Select inches as unit of measure in buffer HSIZ 10.4 // Set width to 10.4 in buffer VSIZ 7.8 // Set height to 7.8 in buffer ALLU // Test the new settings // more format editing commands // ... FMTE // End of editing session</pre>

HSPD

Horizontal Sync Pulse Delay

Class	Format parameter setting - Synchronization
Description	Establishes the delay between the leading edge of blanking and the leading edge of the horizontal sync pulse. The HSPD? query returns the current setting of HSPD.
Command syntax	HSPD <i>pixels</i> <i>pixels</i> min = 1 max = HTOT - HRES - HSPW
Query syntax	HSPD?
Query response	<i>pixels</i>
Other required commands	The FMTU command instructs the generator to use the new settings. The ALLU command updates the hardware to the new settings and redraws the test image.
Example	<pre>HSPD 16 // Set 16 pixel pulse delay in buffer FMTU // Update hardware to current buffer contents</pre>

HSPG

Horizontal Sync Pulse Gate

Class	Format parameter setting - Synchronization
Description	Enables and disables the digital horizontal sync output. The HSPG? query returns the current HSPG mode.
Command syntax	HSPG <i>mode</i> <i>mode</i> 0 = OFF 1 = ON
Query syntax	HSPG?
Query response	0 or 1
Other required commands	To use digital horizontal sync, digital separate H and V sync must be selected with the SSST command. The FMTU command instructs the generator to use the new settings. The ALLU command updates the hardware to the new settings and redraws the test image.
Example	<pre>HSPG 1 // Enable H sync output in buffer FMTU // Update hardware to current buffer contents</pre>

HSPP

Horizontal Sync Pulse Polarity

Class	Format parameter setting - Synchronization
Description	Establishes the logic sense of the digital horizontal sync outputs. Setting polarity to 1 causes the leading edge of horizontal sync to be a low-to-high transition. Setting polarity to 0 causes the leading edge of horizontal sync to be a high-to-low transition. The HSPP? query returns the current polarity of HSPP.
Command syntax	HSPP <i>polarity</i> <i>polarity</i> 0 = active-low (negative going pulse) 1 = active-high (positive going pulse)
Query syntax	HSPP?
Query response	0 or 1
Other required commands	To use digital horizontal sync, it must be gated on with the HSPG command and digital separate H and V sync must be selected with the SSST command. The FMTU command instructs the generator to use the new settings. The ALLU command updates the hardware to the new settings and redraws the test image.
Example	<pre>HSPP 0 // Set active low H sync in buffer HSPG 1 // Enable H sync output in buffer SSST 1 // Select H&V sync type in buffer FMTU // Update hardware to current buffer contents</pre>

HSPW

Horizontal Sync Pulse Width

Class	Format parameter setting - Synchronization
Description	Establishes the width of the horizontal sync pulse. The HSPW? query returns the current setting of HSPW.
Command syntax	HSPW <i>pixels</i> <i>pixels</i> min = 1 max = HTOT - HRES - HSPD
Query syntax	HSPW?
Query response	<i>pixels</i>
Other required commands	The FMTU command instructs the generator to use the new settings. The ALLU command updates the hardware to the new settings and redraws the test image.
Example	<pre>HSPW 32 // Set pulse width to 32 pixels in buffer FMTU // Update hardware to current buffer contents</pre>

HTOT

Horizontal TOTal pixels per line

Class	Format parameter setting - Video resolution
Description	<p>Establishes the total number of pixels per horizontal line. The HTOT? query returns the current setting of HTOT.</p> <p>The pixel rate is equal to HRAT multiplied by HTOT.</p> <p>Note: <i>The current version of the firmware does not allow you to directly enter a specific pixel rate when setting up a format. If your test specifications call for a specific pixel or dot clock rate, enter suitable values for HRAT and HTOT to give you the desired pixel rate.</i></p>
Command syntax	HTOT <i>pixels</i> <i>pixels</i>
Query syntax	HTOT?
Query response	<i>pixels</i>
Other required commands	The FMTU command instructs the generator to use the new settings. The ALLU command updates the hardware to the new settings and redraws the test image.
Example	<pre>HTOT 800 // Set total to 800 FMTU // Update hardware to current buffer contents</pre>

HVPD?

Horizontal Vertical Sync Pulse Delay

Class Format Parameter Setting - Synchronization

Description Returns the pixel delay between the horizontal and vertical sync pulses.

Query syntax HVPD?

Query response number of pixels

Example `HVPD? // read pixel delay between HSYNC and VSYNC pulses`
`1 // one pixel delay`

Related commands None

HVSA

Horizontal Vertical Sync Adjustment

Class	Format parameter setting - Synchronization
Description	Lengthens the serration period a given number of pixels from the format's nominal default value as required by certain military STANAG video formats. The HVSA? query returns the current setting of HVSA.
Command syntax	HVSA <i>pixels</i> <i>pixels</i> integer, 0 and less than HSPW
Query syntax	HVSA?
Query response	<i>pixels</i>
Other required commands	The FMTU command instructs the generator to use the new settings. The ALLU command updates the hardware to the new settings and redraws the test image.
Example	HVSA 30; ALLU

I2CR? (OUT1:I2CR?, OUT2:I2CR?, VGA:I2CR?)

I2C port Read

Class EDID and DDC control

Description Automatically reads data using a specified I2C protocol. This command reads data from the specified connector, bus and device using the I²C bus. If no connector is specified, the query defaults to OUT1 or VGA depending on the active output. All numeric parameters are given in ASCII HEX.

Note: EDID-compatible receivers use EPROMs with single-byte or double-byte addresses. The I2CR? query uses different parameters depending on the EPROM type. To determine which EPROM type is used, try both syntaxes until you can read data from the EPROM.

Query syntax (EPROM with single-byte addresses) *connector:i2cr? bus_name i2c_address offset #_of_bytes*

Query syntax (EPROM with double-byte addresses) *connector:i2cr? eprom1 i2c_address offset #_of_bytes*

Query syntax (device protocol) *connector:i2cr? bus_name i2c_address offset #_of_bytes*

connector

OUT1, OUT2 = HDMI OUT 1 or HDMI OUT 2 connector

VGA = VGA connector

bus_name (optional - text)

device queried(eprom, eprom1, TV, DT, HT, HR)

i2c_address (hex)

i²c bus address (A0, A1,...)

offset (hex)

address offset (in bytes)

#_of_bytes (hex)

number of bytes

Example 1 This example reads 10 bytes of E-EDID data, using the I2C e_ddc protocol.

```
R:\>i2cr? eprom a0 80 10
02031A76478502030406070123090707
```

Example 2 This command reads four register bytes values from the transmitter TV chip of the generator

```
i2cr? tv 89 00 04  
82021402
```

Example 3 This command reads the HDCP Bksv value from a receiver

```
i2cr? 74 00 05  
07BE05CEA9
```

Example 4 This command reads two bytes of register values from the transmitter (output 1) HDMI chip of the generator

```
i2cr? HT1 7a 00 02  
0002
```

Related commands [EDA<port>:GDID](#), [I2CW \(OUT1:I2CW, OUT2:I2CW, VGA:I2CW\)](#)

I2CW (OUT1:I2CW, OUT2:I2CW, VGA:I2CW)

I2C port Write

Class EDID and DDC control

Description Writes raw binary data data using a specified I2C protocol. This command writes data to the specified connector, bus and device using the I²C bus. If no connector is specified, the query defaults to OUT1 or VGA depending on the active output. All numeric parameters are given in ASCII HEX.

Note: EDID-compatible receivers use EPROMs with single-byte or double-byte addresses. The I2CW command uses different parameters depending on the EPROM type.

Important: When writing data with this command, ensure you send only 8 bytes of data at a time. This is necessary since most EPROMs do not have a larger memory buffer.

Command syntax (EPROM with single-byte addresses) `connector:I2CW bus_name i2c_address offset data`

Command syntax (EPROM with double-byte addresses) `connector:I2CW eprom1 i2c_address offset #_of_bytes data`

Command syntax (device protocol) `connector:I2CW bus_name i2c_address offset data`

connector

OUT1, OUT2 = HDMI OUT 1 or HDMI OUT 2 connector

VGA = VGA connector

bus_name (optional - text)

device queried (eprom, eprom1, TV, DT, HT1, HR)

i2c_address (hex)

i²c bus address (A0, A1,...)

offset (hex)

address offset (in bytes)

data (hex)

the data that you want to send to the register

Example 1 This example writes two bytes of E-EDID data, using the I2C e_ddc protocol.

```
i2cw eprom a0 80 2 FFFF
```

Example 2 This command writes four register bytes values from the transmitter TV chip of the generator.

```
i2cw tv 89 00 04 FFFFFFFF
```

Related commands [XDID](#), [I2CR?](#) ([OUT1:I2CR?](#), [OUT2:I2CR?](#), [VGA:I2CR?](#))

IFGU

InfoFrame Generator Use

Class [InfoFrame Packet](#)

Description Updates hardware with current InfoFrame contents.

Command syntax IFGU

Example IFTG 14
IFGU

Related commands [IFTG](#), [IFTR](#), [XGIF](#), [XAVI](#), [XSPD](#), [XAUD](#), [XMPG](#)

IFTG

InfoFrame Type Gate

Class [InfoFrame Packet](#)

Description Gates the InfoFrames by type. The mask value is a value ORed with the current setting.

Note: For more information about the InfoFrame structure, see the EIA Standard EIA/CEA-861-B (Section 6).

Command syntax IFTG *mask*

mask

A bit mask based on these InfoFrame type values.

Type	Value
GIFA	1
AVI	2
SPD	4
AUD	8
MPG	16
GIFB	32

Example This example enables AUD (8), SPD (4), and AVI (2) InfoFrames (but not MPG and GIF InfoFrames). The MPG, GIFA and GIFB InfoFrames are gated off, and loaded with zeros.

```
IFTG 14  
IFGU
```

Related commands [IFGU](#), [IFTR](#)

IFTR

InfoFrame Type Repeat Mask

Class [InfoFrame Packet](#)

Description Specifies if an InfoFrame type is to be sent once (after the [IFGU](#) command is executed), or sent in every vertical blanking period (frame).

Note: For more information about the InfoFrame structure, see the EIA Standard EIA/CEA-861-B (Section 6).

Command syntax IFTR *mask*

mask

A bit mask based on these InfoFrame type values.

Type	Value
GIFA	1
AVI	2
SPD	4
AUD	8
MPG	16
GIFB	32

Example This example specifies that AUD (8) and AVI (2) InfoFrames should be repeated with every frame, and other InfoFrame types should be sent once.

```
IFTR 10  
IFGU
```

Related commands [IFTG](#), [IFGU](#)

IMGA

IMaGe save As

Class Image memory management

Description Saves the current contents of the image edit buffer using the given name.

Command syntax `IMGA name`

name

a valid MS-DOS filename (8 characters minus any extension)

Example `IMGA MY_IMG // Save with the name "MY_IMG"`

IMGB

IMaGe editing Begin

Class Image editor control

Description Marks the beginning of an image editing session.

Command syntax IMGB

Other required commands Use either an [IMGL](#) command to load an existing image or an [IMGN](#) command to create a new image. Use [IMGE](#) when ending the editing session.

```
Example  IMGN // Initialize image edit buffer
         IMGB // Start image editing session

         // One or more image editing
         // commands ...

         IMGE // End image editing session
```

IMGE

IMaGe editing End

Class Image editor control

Description Marks the end of an image editing session.

Command syntax IMGE

Other required commands Use [IMGB](#) when starting the editing session. Use [IMGA](#) or [IMGS](#) to save changes.

```
Example  IMGB          // Start image editing session
          // One or more image editing commands ...
          IMGA MYIMG_02 // Save edited image as "MYIMG_02"
          IMGE          // End image editing session
```

IMGK

IMaGe Kill

Class Image memory management

Description Deletes an image by name. The query returns a 1 if the named image can be deleted. If the image is read-only or nonexistent, the query returns a 0.

Command syntax `IMGK name`
name
a valid MS-DOS filename (8 characters minus any extension)

Query syntax `IMGK? name`
name
a valid MS-DOS filename (8 characters minus any extension)

Query response 0 or 1

Example `IMGK MY_IMG // Delete dir called "MY_IMG"`

IMGL

IMaGe Load

Class	Image memory management
Description	<p>Assigns an image to the current step of a sequence while between a set of SEQB and SEQE commands. The IMGL command is context sensitive. The IMGL? query returns the name of the image currently assigned to the step.</p> <p>Outside of the sequence editor, the IMGL command copies the image having a name equal to name from image memory into the image edit buffer. The query returns a one (1) if the named image can be loaded, otherwise a zero (0) is returned.</p>
Command syntax	<p>IMGL <i>name</i></p> <p><i>name</i> a valid MS-DOS filename (8 characters minus any extension)</p>
Query syntax	<p>IMGL? <i>name</i></p> <p><i>name</i> a valid MS-DOS filename (8 characters minus any extension)</p>
Query response	0 or 1
Other required commands	An ALLU or IMGU command must be executed after the IMGL command to cause the image in the edit to draw on the unit under test.
Example	<pre>IMGL MY_IMG // Load "MY_IMG" dir in edit buffer IMGU // Draw contents of buffer</pre>

IMGN

IMaGe New

Class	Image editor control
Description	Initializes the image edit buffer. The name <i>name</i> is assigned as the image's name. The query will return the name that has been assigned as the image's name.
Command syntax	<i>IMGN name</i> <i>name</i> optional valid MS-DOS filename (8 characters minus any extension)
Query syntax	IMGN?
Query response	name
Example	<pre>IMGN // Init edit buffer without assigning a new name or IMGN MY_IMG // Init edit buffer with name of "MY_IMG"</pre>

IMGP

IMaGe Path

Class	Image memory management
Description	Sets the current image path name to a given directory. The query will return the current image path name.
Command syntax (flash memory/PC card)	IMGP <i>path name</i> <i>path name</i> a valid MS-DOS filename (8 characters minus any extension)
Command syntax (file server)	IMGP <i>server name:</i> <i>server name</i> valid hostname (no forward slash before name, and colon after name)
Query syntax	IMGP? <i>name</i> <i>name</i> a valid MS-DOS filename (8 characters minus any extension)
Query response	<i>name</i>
Example	IMGP FINAL // Sets image pathname to a directory called "FINAL". IMGP hostname1: // Sets image pathname to "HOSTNAME1" file server.

IMGQ?

IMaGe Query pointer

Class	Image memory management
Description	Returns number image names from the list of all the images stored in image memory beginning at index. The images are kept in alphanumeric order.
Query syntax	<i>IMGQ? index number</i> <i>index</i> positive integer number <i>number</i> positive integer number
Query response	List of specified image names
Example	<code>IMGQ? 1 5 // List the first five images in memory</code> or <code>IMGQ? 1 9999 // List all images in memory</code>

IMGS

IMaGe Save

Class Image memory management

Description Saves the current contents of the generator's custom image edit buffer back to the memory location from which it was originally read.

Command syntax IMGS

IMGU

IMaGe Use

Class Image memory management

Description Draws an image based on the current contents of the image. The IMGU? query returns the image memory location *location* from which the current contents of the image were read.

Command syntax IMGU

Query syntax IMGU?

Query response *location*
location
-1 through -26 (EPROM)

Example `IMGL BriteBox // Select the BriteBox test image`
`IMGU // Draw the selected test image`

INIT

INITialize to factory default settings

Class Direct processor control

Description Restores the contents of all of the generator's RAM storage locations to factory-default conditions. The generator then goes through a complete self-test and self-calibration procedure.

Important: The *INIT* command permanently and irreversibly removes all user-created formats, custom images, test sequences, and directories from memory.

Command syntax INIT

ISHA

ImageShift save As

Class

Description Saves the current contents of the imageshift edit buffer using the specified name.

Command syntax ISHA *filename*

filename

a valid MS-DOS filename (8 characters minus any extension)

Example ISHA Myshift1 // Saves with the name Myshift1

Related commands [ISHB](#), [ISHE](#), [ISHG](#), [ISHK](#), [ISHL](#), [ISHN](#), [ISHP](#), [ISHQ?](#), [ISHS](#), [ISHU](#), [XISH:HINC](#), [XISH:PATH](#), [XISH:SRCN](#), [XISH:TINC](#), [XISH:TTYP](#), [XISH:VINC](#)

ISHB

ImageShift edit Begin

Class

Description Marks the beginning of an imageshift editing session.

Command syntax ISHB

Other required commands Use either an ISHL command to load an existing imageshift file or an ISHN command to create a new imageshift file. Use ISHE when ending the editing session.

Example `ISHB // Begin imageshift editing session`

Related commands [ISHA](#), [ISHE](#), [ISHG](#), [ISHK](#), [ISHL](#), [ISHN](#), [ISHP](#), [ISHQ?](#), [ISHS](#), [ISHU](#), [XISH:HINC](#), [XISH:PATH](#), [XISH:SRCN](#), [XISH:TINC](#), [XISH:TTYP](#), [XISH:VINC](#)

ISHE

ImageShift edit End

Class

Description Marks the end of an imageshift editing session.

Command syntax ISHE

Other required commands Use ISHS when starting the editing session. Use ISHS or ISHA to save changes.

Example `ISHE // End imageshift editing session`

Related commands [ISHA](#), [ISHB](#), [ISHG](#), [ISHK](#), [ISHL](#), [ISHN](#), [ISHP](#), [ISHQ?](#), [ISHS](#), [ISHU](#), [XISH:HINC](#), [XISH:PATH](#), [XISH:SRCN](#), [XISH:TINC](#), [XISH:TTYP](#), [XISH:VINC](#)

ISHG

ImageShift Gate

Class

Description Enables and disables the image shifting function. The ISHG? query returns the current ISHG mode.

Command syntax `ISHG mode`
mode
0 = OFF
1 = ON

Query syntax `ISHG?`

Query response 0 or 1

Example `ISHG 1 //Enables the image shifting function.`

Related commands [ISHA](#), [ISHB](#), [ISHE](#), [ISHK](#), [ISHL](#), [ISHN](#), [ISHP](#), [ISHQ?](#), [ISHS](#), [ISHU](#), [XISH:HINC](#), [XISH:PATH](#), [XISH:SRCN](#), [XISH:TINC](#), [XISH:TTYP](#), [XISH:VINC](#)

ISHK

ImageShift Kill

Class

Description Deletes the specified imageshift file.

Command syntax ISHK *path/filename*
path/filename

The directory path and valid MS-DOS filename (8 characters minus any extension) of the file to be deleted. If the file to be deleted is in the default path, then *path/* may be omitted.

Example ISHK Myshift1 // Deletes the imageshift file named Myshift1

Related commands [ISHA](#), [ISHB](#), [ISHE](#), [ISHG](#), [ISHL](#), [ISHN](#), [ISHP](#), [ISHQ?](#), [ISHS](#), [ISHU](#), [XISH:HINC](#), [XISH:PATH](#), [XISH:SRCN](#), [XISH:TINC](#), [XISH:TTYP](#), [XISH:VINC](#)

ISHL

ImageShift Load

Class

Description Loads the values from the specified imageshift file.

Command syntax ISHL *path/filename*

path/filename

The directory path and valid MS-DOS filename (8 characters minus any extension) of the file to be loaded. If the file to be loaded is in the default path, then *path/* may be omitted.

Example ISHL Myshift1 // Loads the imageshift file named Myshift1

Related commands [ISHA](#), [ISHB](#), [ISHE](#), [ISHG](#), [ISHN](#), [ISHP](#), [ISHQ?](#), [ISHS](#), [ISHU](#), [XISH:HINC](#), [XISH:PATH](#), [XISH:SRCN](#), [XISH:TINC](#), [XISH:TTYP](#), [XISH:VINC](#)

ISHN

ImageShift New file

Class

Description Creates a new imageshift file with the name specified by *filename*.

Command syntax ISHN *filename*

filename

a valid MS-DOS filename (8 characters minus any extension)

Example This example creates the file *Myshift1* in the */imageshifts* directory on the generator.

```
ISHN Myshift1 //Creates an imagefile named Myshift1
```

Related commands [ISHA](#), [ISHB](#), [ISHE](#), [ISHG](#), [ISHK](#), [ISHL](#), [ISHP](#), [ISHQ?](#), [ISHS](#), [ISHU](#), [XISH:HINC](#), [XISH:PATH](#), [XISH:SRCN](#), [XISH:TINC](#), [XISH:TTYP](#), [XISH:VINC](#)

ISHP

set ImageShift Path

Class

Description Sets the default imageshift path.

Command syntax ISHP *path*
path
path to directory containing imageshift files

Query syntax ISHP?

Query response *path*

Example 1 This example sets the default path to the */imageshifts* directory.

```
ISHP /tffs0/library/imageshifts
```

Example 2 This example queries the generator for the current imageshift path setting.

```
ISHP? //Query for the current imageshift path  
/tffs0/library/imageshifts //current path
```

Related commands [ISHA](#), [ISHB](#), [ISHE](#), [ISHG](#), [ISHK](#), [ISHL](#), [ISHN](#), [ISHQ?](#), [ISHS](#), [ISHU](#), [XISH:HINC](#), [XISH:PATH](#), [XISH:SRCN](#), [XISH:TINC](#), [XISH:TTYP](#), [XISH:VINC](#)

ISHQ?

ImageShift Query pointer

Class

Description Returns a list of up to 5 imageshift filenames from the list of all the imageshift files in a directory. Querying repeatedly will eventually exhaust the list of filenames.

Query syntax ISHQ?

Query response List of imageshift filenames.

Example
ISHQ? //List the first 5 imageshift filenames.
ISHQ? //List the next 5 imageshift filenames.

Related commands [ISHA](#), [ISHB](#), [ISHE](#), [ISHG](#), [ISHK](#), [ISHL](#), [ISHN](#), [ISHP](#), [ISHS](#), [ISHU](#), [XISH:HINC](#), [XISH:PATH](#), [XISH:SRCN](#), [XISH:TINC](#), [XISH:TTYP](#), [XISH:VINC](#)

ISHS

ImageShift Save

Class

Description Saves the current imageshift values to the filename established using the ISHN command. If no ISHN command has been issued, then the values are saved to the default filename Shift1.xml.

Command syntax ISHS

Example

```
ISHN Newshift //Creates a new imageshift file named NEWSHIFT
ISHB //Begins an imageshift editing session
XISH:SRCN cache0/images/SMPTEBar //selects the SMPTEBar image
XISH:PATH 0,0 150,20 //Sets the imageshift path x,y coordinates
XISH:TTYP 1 //Sets the trace type to Repeat (1)
ISHE //Ends the imageshift editing session
ISHS //Saves the values to the NEWSHIFT file
```

Related commands [ISHA](#), [ISHB](#), [ISHE](#), [ISHG](#), [ISHK](#), [ISHL](#), [ISHN](#), [ISHP](#), [ISHQ?](#), [ISHU](#), [XISH:HINC](#), [XISH:PATH](#), [XISH:SRCN](#), [XISH:TINC](#), [XISH:TTYP](#), [XISH:VINC](#)

ISHU

ImageShift Use

Class

Description Applies the current imageshift file values to the hardware.

Command syntax ISHU

Example ISHL Newshift //Loads the imageshift file named NEWSHIFT
ISHU //Applies NEWSHIFT values to the hardware

Related commands [ISHA](#), [ISHB](#), [ISHE](#), [ISHG](#), [ISHK](#), [ISHL](#), [ISHN](#), [ISHP](#), [ISHQ?](#), [ISHS](#), [XISH:HINC](#),
[XISH:PATH](#), [XISH:SRCN](#), [XISH:TINC](#), [XISH:TTYP](#), [XISH:VINC](#)

ISTP?

Image SStep

Class	Image editor control
Description	Allows the contents of user created custom images to be copied out of a generator. The contents of the firmware-based, built-in test images cannot be read out since they are not created as a set of primitives.
Query syntax	ISTP? returns the number of steps in the custom image in the edit buffer. or ISTP? <i>step_number</i> returns the contents of the given step in the custom image in the edit buffer as a space delimited text string.
Other required commands	A custom image must have been loaded with the IMGL command and editing must have been started with the IMGB command

ISUB

Image Step Button

Class System parameter settings

Description Determines if the Image Step key is on or off to allow activation of alternate versions of test images that have alternate versions.

The ISUB? query returns the current setting of ISUB.

Command syntax ISUB *mode*

mode

0 = OFF

1 = ON

Query syntax ISUB?

Query response 0 or 1

```
Example  IMGL SlideBox // Load image
         ISUB 1 // Enable alternate versions
         IVER 1 // Load version 1
         IMGU // Update display
```

IVER

Image VERsion

Class	System parameter settings
Description	<p>Determines which version of an image is used for the current step of a sequence while between a set of SEQB and SEQE commands. The IVER command is context sensitive. The IVER? query returns the version currently assigned to the step.</p> <p>Outside of the sequence editor, the IVER command selects which version of the current image is drawn when either an ALLU or IMGU command is executed. The IVER? query returns the current setting of IVER.</p>
Command syntax	<p>IVER <i>mode</i></p> <p><i>mode</i></p> <ul style="list-style-type: none">0 = Normal1 = Invert or display alternate version
Query syntax	IVER?
Query response	0 or 1
Other required commands	The IMGU command redraws an image using the new setting. The ALLU command updates hardware and redraws the test image with the new setting.
Example	<pre>IMGL Text_9 // Select image with white text on black IVER 1 // Select inverted with black on white IMGU // Draw the image as selected</pre>

JDVI

Justify pixel clock rate for DVI formats

Class	Format editor control
Description	Enables setting of the upper and lower bound for the pixel rate of the HDMI-D and HDMI-H outputs. The command takes two parameters: 1) upper frequency parameter and 2) lower frequency parameter. You can set either values or both values but you have to enter the first parameter if you want to set the second parameter value. The default values for HDMI-H and HDMI-D are 165MHz for the upper limit and 25MHz for the lower limit.
Command syntax	<pre>JDVI upper_pixel_rate lower_pixel_rate upper_pixel_rate lower_pixel_rate floating point number equal to the desired pixel in MHz</pre>
Query syntax	JDVI?
Query response	<pre>upper_pixel_rate lower_pixel_rate</pre>
Other required commands	The ALLU command updates hardware to the new settings and redraws the test image.
Examples	<pre>JDVI 165E06 20E06 // sets the lower limit pixel rate to 20MHz ALLU JDVI 170E06 25E06 // sets the upper limit pixel rate to 170MHz ALLU JDVI 175E06 23E06 // sets the upper limit pixel rate to 175MHz and the lower limit to 23MHz ALLU JDVI? +175.000E+06, +23.000E+06</pre>

JLDI

Justify pixel clock rate for LDI formats

Class	Format editor control
Description	Scales the horizontal timing parameters of the format currently in the edit buffer. (For the 801LD used in digital mode, the default is set at 224 MHz.) The parameters are scaled to produce the given pixel rate while keeping the horizontal scan rate as close as possible to its original value. The following parameters are scaled: horizontal total pixels, horizontal active pixels, horizontal sync delay in pixels, and horizontal sync pulse width in pixels. The parameters are scaled so that their periods, in microseconds, are as close as possible to their original values.
Command syntax	JLDI <i>pixel_rate</i> <i>pixel_rate</i> floating point number equal to the desired pixel in MHz
Query syntax	JLDI?
Query response	<i>pixel_rate</i>
Other required commands	The ALLU command updates hardware to the new settings and redraws the test image.

JRAT

Justify pixel clock RATE

Class Format editor control

Description Scales the horizontal timing parameters of the format currently in the edit buffer. The parameters are scaled to produce the given pixel rate while keeping the horizontal scan rate as close as possible to its original value. The following parameters are scaled: horizontal total pixels, horizontal active pixels, horizontal sync delay in pixels, and horizontal sync pulse width in pixels. The parameters are scaled so that their periods, in microseconds, are as close as possible to their original values.

Command syntax JRAT *pixel_rate*
pixel_rate
floating point number equal to the desired pixel in MHz

Other required commands The [ALLU](#) command updates hardware to the new settings and redraws the test image.

Example JRAT 202.000E6 // Adjust timing to a 202.000 MHz clock
FMTU // Update hardware to current buffer contents

LCDS?

LCD Status

Class System parameter settings

Description Returns text displayed on LCD of the generator.

Query syntax LCDS?

Example

```
LCDS? // Return text similar to text below
      // H32 15=VGA_m3 crlf
      // V60 51=SMPTE133
```

LEDS?

LED Status

Class	System parameter settings
Description	<p>Returns the current status of the generator's signal generating hardware as a single decimal number. The number corresponds to the status of the lighted key on the generator in normal operation. The easiest way to interpret the number is to first convert it to an 8-digit binary number. A 1 in a given position, from MSB to LSB, corresponds to the following hardware settings:</p> <ul style="list-style-type: none">Master output control gated ON (MSB)Digital Separate (HS&VS) Sync selectedDigital Composite Sync selectedAnalog Composite Sync selectedBlue video enabledGreen video enabledRed video enabledAlternate image version selected (LSB)
Query syntax	LEDS?
Query response	decimal number from 0 to 255
Example	<pre>LEDS? // Returns the following number when the outputs are gated ON, separate // HS & VS is selected, the red, green and blue video channels are // enabled and the primary version of an image is selected. 206 // Binary equivalent = 11001110</pre>

LEVP

Increment LEVels Per color component

Class	Image memory management	
Description	Enables you to increment the color component (R,G,B) levels in any increment.	
Command syntax	LEVP <i>value</i> <i>value</i> an interger number that is a percent in increments of 1	
Query syntax	LEVP?	
Query response	Returns an interger value representing a percent from 0 to 100	
Example 1	LEVP 33	// Sets the color component values for R,G,B to 33% of maximum color
Example 2	LEVP? 45	// Returns a value representing a percent of color component values // Indicates that the color component value is 45% of maximum

LEVP:R

Increment LEVels Per individual color component

Class	Image memory management
Description	Enables you to increment the color component (R,G,B) values in any increment (1 to 100) for each component color individually.
Command syntax	<p>LEVP:<i>color value</i></p> <p><i>color</i> a color component either R, G, B</p> <p><i>value</i> an interger number that is a percent in increments of 1</p>
Query syntax	<p>LEVP:<i>color?</i></p> <p><i>color</i> a color component either R, G, B</p>
Query response	Returns an interger value representing a percent from 0 to 100
Example 1	<pre>LEVP:R 33 // Sets the red color component values to 33% of maximum color</pre>
Example 2	<pre>LEVP:G 90 // Sets the green color component values to 33% of maximum color</pre>
Example 3	<pre>LEVP:B? // Returns a value representing a percent of color value for the blue component 45 // Indicates that the color component value is 45% of maximum</pre>

LIMI

draw video LIMIts markers

Class	Custom image primitive
Description	Places nine markers that define the active video area. An L-shaped marker is placed at each corner. T-shaped markers are centered along each edge of video, and a small cross is placed at the center of video. The primitive uses a single parameter: color.
Command syntax	<code>LIMI <i>color</i></code> <code><i>color</i></code> available colors
Other required commands	The FMTU command instructs the generator to use the new setting. The ALLU command updates hardware to the new setting and redraws the test image.
Example	<pre>LIMI white // Place white markers that define active video area ALLU // Update hardware to current buffer contents</pre>

LINE

draw a LINE

Class	Custom image primitive
Description	Draws a line between any two points. The line is 1 pixel thick. The primitive uses five parameters: the color and x,y coordinates for both endpoints.
Command syntax	<pre>LINE <i>color</i> <i>x_start</i> <i>y_start</i> <i>x_end</i> <i>y_end</i> <i>color</i> available colors <i>x_start</i>, <i>y_start</i>, <i>x_end</i>, <i>y_end</i> positive integer number</pre>
Other required commands	The FMTU command instructs the generator to use the new setting. The ALLU command updates hardware to the new setting and redraws the test image.
Example	<pre>LINE yellow 20 5 320 240 // Draw yellow line from X=20, Y=5 to X=320, Y=240 ALLU // Update hardware to current buffer contents</pre>

LMAX

Digital Video Maximum quantizing Level

Class Format parameter setting - Digital video signal

Description Sets the maximum quantizing level of the component video signal for white. The default varies depending on the number of bits per color component. Some applications may require that the maximum level be set lower than the maximum permissible. The query reads the current setting for the maximum level.

Command syntax *LMAX video_level*
video_level
unsigned integer from 59 to 63 when NBPC is 6 gamuts; 235 to 255 when NBPC is 8 gamuts; 940 to 1023 when NBPC is 10 gamuts; 3760 to 4095 when NBPC is 12 gamuts.

Query syntax LMAX?

Example LMAX 254 // To set the maximum digital quantizing level to 254

Related commands [LMIN](#), [NBPC](#), [DVQM](#)

LMIN

Digital Video Minimum quantizing Level

Class Format parameter setting - Digital video signal

Description Sets the minimum quantizing level of the component video signal for black. The default is 0 for black; however, some applications may require that the minimum level be set higher. The query reads the current setting for the minimum level.

Command syntax LMIN *video_level*
video_level
unsigned integer from 0 to 4 when NBPC is 6 gamuts; 0 to 16 when NBPC is 8 gamuts; 0 to 64 when NBPC is 10 gamuts; 0 to 256 when NBPC is 12 gamuts

Query syntax LMIN?

Example LMIN 16 // To set the minimum digital quantizing level to 16

Related commands [LMAX](#), [NBPC](#), [DVQM](#)

LS?

LS?

Class Tools

Description Lists the contents of the current directory.

Query syntax LS?

Query response List of file names is presented.

Related commands None

Example LS?
barpulse.o
boxquart.o
diamond.o
tceburst.o
barsmpte.o

LSPG

Line Sync Pulse Gate

Class	Format parameter settings
Description	Enables and disables the digital horizontal sync output. The LSPG? query returns the current LSPG mode.
Command syntax	LSPG <i>mode</i> <i>mode integer</i> 0 = OFF 1 = ON
Query syntax	LSPG?
Query response	0 or 1
Other required commands	The FMTU command instructs the generator to use the new settings. The ALLU command updates the hardware to the new settings and redraws the test image.
Example	<pre>LSPG 1 // Enable Line Sync FMTU // Update hardware to new settings</pre>

LSPP

Line Sync Pulse Polarity

Class	Format parameter setting - Synchronization
Description	Establishes the logic sense of the digital line sync output. Setting polarity to 1 causes the leading edge of line sync to be a low-to-high transition. Setting polarity to 0 causes the leading edge of line sync to be a high-to-low transition. The LSPP? query returns the current polarity of LSPP.
Command syntax	LSPP <i>polarity</i> <i>polarity</i> 0 = active-low (negative going pulse) 1 = active-high (positive going pulse)
Query syntax	FSPP?
Query response	0 or 1
Other required commands	In order to get a pulse, line sync must first be enabled with the LS? command. The FMTU command instructs the generator to use the new settings. The ALLU command updates the hardware to the new settings and redraws the test image.
Example	<pre>LSPG 1 // Enable Line Sync LSPG 1 // Set for positive going pulse LSPW 20 // Make the pulse 20 pixels wide LSPG 300 // Pulse to occur 300 lines after // the last line of active video FMTU // Update hardware to new settings</pre>

MODE

communications MODE

Class System parameter settings

Description Sets the serial port communications parameters of a stand-alone model generator. The changes take effect as soon as the command is entered. The factory default settings are baud, no parity, 8 data bits, no stop bits, no handshake (handshake), and no protocol.

Command syntax `MODE baud parity data stop handshake protocol`

baud rate

300, 600, 1200, 2400, 4800, 9600, 19200, 38400, 57600, or 115200 bits/sec

parity

N = None, E = Even or O = Odd

data

number of data bits: 7 or 8

stop

number of stop bits: 1 or 2

handshake

N = None

H = Hardware (CTS/RTS)

protocol

N = None

Y=Y-Modem

Example `MODE 9600 N 8 1 H N // Set a stand alone generator to
// communicate at 9600 Baud, No parity, 8 data bits,
// 1 stop bit, RTS//CTS handshaking and No protocol`

or

`MODE 2400 // Change only the baud rate`

MSIZ

light Meter SIZE

Class	System parameter settings
Description	Establishes the physical size of the light meter boxes displayed in the BriteBox test image. The unit of measure used is based on the current setting of the system level USIZ command. It also affects the size of the cursor boxes in the Persist image. Changing the size will not change the currently displayed image. The MSIZ? query returns the current settings of MSIZ based on the current setting of the system level USIZ command.
Command syntax	<i>MSIZ width height</i> or <i>MSIZ common_size</i> <i>size</i> positive floating point number <i>common_size</i> square box
Query syntax	MSIZ?
Query response	<i>width, height</i>
Other required commands	The correct unit of measure should be selected with the USIZ command prior to setting the size.
Example	<pre>USIZ 1 // Select inches for units MSIZ 2.0 // Set size to 2.0 inches IMGL BriteBox // Select BriteBox image IMGU // Draw selected image using new size</pre>

MUTE

Audio/Video Mute

Class	Parameters (Audio Signal and Timing)
Description	Enables and disables the HDMI Audio/Video Mute (AVMUTE) feature. When enabled, audio and video are muted by the generator.
Command syntax	MUTE <i>flag</i> <i>flag</i> 0 = disable (AVMUTE_clear_flag sent repeatedly) 1 = enable (AVMUTE_set_flag sent repeatedly)
Query syntax	MUTE?
Query response	0 or 1
Example	To enable AVMUTE: MUTE 1 MUTE? Use the MUTE? to continuously check until the AVMUTE state is changed (may not take place right away).

NAMF?

NAME Find

Class Directory editor control

Description Returns the index number of the entry with name *name* in the directory edit buffer. The first name in the buffer has an index value of 1. If name is not found, a value of 0 is returned.

Query syntax NAMF? *name*
name
a valid MS-DOS filename (8 characters minus any extension)

Query response *index*

Example NAMF? VGA_m4 // Return position of VGA_m4 in directory

NAMI

NAME Insert

Class Directory editor control

Description Moves all the names with index values equal to or greater than *index* to the next higher index value in the directory edit buffer, and then inserts the name *name* in the directory edit buffer at position *index*. A negative number or a 0 used for *index* will put *name* at index position 1. Using a number for *index* beyond the last name in the buffer will add *name* to the index position just beyond the last name. The command does not check if a file called *name* is stored in the generator.

Command syntax NAMI *index name*
name
a valid MS-DOS filename (8 characters minus any extension)

Example 1 This example inserts the DMT0660A format on the knob list at location 1:

```
DIRL FMT
DIRB
NAMI 1 DMT0660A
DIRE
DIRS
```

Example 2 NAMI 5 FOCUS1 // Put FOCUS1 in fifth position

Example 3 NAMI -6 BARS // Put BARS at beginning of dir

Example 4 NAMI 999999 HATCH // Put HATCH at end of dir

NAMK

NAME Kill

Class Directory editor control

Description Deletes the given name from the directory edit buffer. All names with index values greater than the index of the deleted name are moved to the next lower index value in the buffer. Nothing happens if name is not found in the buffer.

Command syntax `NAMK name`
name
a valid MS-DOS filename (8 characters minus any extension)

Example `NAMK VGA_m4 // Remove VGA_m4 from dir`

NAMQ?

NAME Query

Class Directory editor control

Description Returns number names from the list of names in the directory edit buffer beginning at *index*. The generator maintains internal variables for the current *index* and *number* values. The value of *index* is automatically incremented by *number* after the query is executed. Sending the query with just an index parameter, will return the same number of names as the last time, starting at the given index. Sending the query with no parameters will return the next set of names in the directory buffer.

Query syntax `NAMQ? index number`
index
positive integer number
number
positive integer number

Query response List of specified entry names from directory edit buffer.

Example 1 `NAMQ? 1 9999 // List the entire buffer`

Example 2 `NAMQ? 1 10 // List the first ten names in the buffer`
`NAMQ? 21 // List the 21st through the 30th names in the buffer`
`NAMQ? // List the 31st through the 40th names in the buffer`

NAMY

NAME Yank

Class Directory editor control

Description Deletes the name at the given index number from the directory edit buffer. All names with index values greater than the index of the deleted name are moved to the next lower index value in the buffer. Nothing happens if index is beyond the index number of last name in the buffer.

Command syntax `NAMY index`

Example `NAMY 2 // Remove second item from dir`

NBPA

Number Bits Per Audio sample

Class Format parameter setting - Audio signal

Description Sets the number of bits per audio sample for an audio signal. This sets the SS parameter of the Audio InfoFrame (as specified in EIA/CEA-861-B, table 20).

Command syntax NBPA *bits*

bits

0 (let incoming external audio stream determine the number of bits per sample)

16

20 (882E only)

24 (882E only)

Example NBPA 16
IFGU

Related commands [XAUD](#) (SS parameter), [SAMP](#)

NBPC

Number Bits Per Component

Class Format parameter setting - Digital video signal

Description Sets the number of bits per color component (color depth).

Command syntax NBPC *bits*

bits

6, 8, 10, or 12 depending on output.

Output	NBPC
DVI	8
TV	12
LVDS	6 (18-bit encoding) or 8 (24-bit encoding)
HDMI Digital RGB or YCbCr 4:4:4 output	8
HDMI YCbCr 4:2:2 output	8, 10, or 12.
SDI HD-SDI 4:2:2	8 or 10

Example NBPC 10
FMTU

Related commands [DVSM](#), [DVQM](#)

N CPP

Number Clocks Per Pixel

Class Format parameter setting - Digital video signal

Description Specifies the number of clocks per pixel (double-clocking factor for whole line). Some industry standard formats (e.g. 480i) have pixel rates that are below the minimum pixel rate restriction (of 25 MHz) required by the TMDS interface. In these cases, a feature known as “double-clocking” is used to raise the TMDS clock rate to an acceptable frequency.

Double-clocking is controlled by the N CPP format parameter. When N CPP is set to 1 (normal single-clocked), each pixel, output by the generator, is paired with one clock pulse. In this case, the pixel rate is equal to the TMDS clock rate. By setting N CPP to 2 (double-clocked), two clocks are send during each pixel period and the TMDS clock rate is raised to 2 times the pixel rate.

Note that double clocking with N CPP and pixel repetition (N PPP) cannot be applied at the same time.

Command syntax N CPP *factor*
factor
1 or 2

Related commands [NBPA](#), [N PPP](#)

Example N CPP 2
FMTU

NDAC

Number Digital Audio Channels

Class Format parameter setting - Audio signal

Description Sets the number of digital audio channels for an audio signal. This sets the CC parameter of the Audio InfoFrame (as specified in EIA/CEA-861-B, table 20).

Command syntax NDAC *channels*
channels
2 or 8

Example NDAC 2
ALLU

Related Commands [XAUD](#) (CC parameter)

NDAS

Number Digital Audio Streams

Class Format parameter setting - Audio signal

Description Sets the number of digital audio streams.

Note: *Currently, only one audio stream is supported.*

Command syntax NDAS *streams*
streams
1 (default)

Example NDAS 1
IFGU

NERR?

Number of ERRors in queue

Class System memory management

Description Returns the number of errors waiting to be reported in the error queue.

Query syntax NERR?

Query response number of errors

NLNK

Number of digital LiNKs

Class	Format parameter setting - Digital video signal
Description	Determines the number of links used by the LVDI digital outputs on generators that support LVDI outputs. The NLNK? query returns the current setting of NLNK.
Command syntax	NLNK <i>links</i> <i>links integer</i> 0 = Default, let the generator decide 1 = Single link 2 = Dual link
Query syntax	NLNK?
Query response	<i>links</i>
Other required commands	The FMTU command instructs the generator to use the new setting. The ALLU command updates hardware to the new setting and redraws the test image.
Example	NLNK 2; FMTU

NOGA

use NO GAMMA correction

Class Custom image primitive

Description Temporarily disables any gamma correction that may be selected in a format. All color intensity levels in all parts of the custom image are output without gamma correction. Gamma correction is disabled only for as long as the image is displayed.

Command syntax NOGA

NOTU

NOT Until communication is complete

Class	System Level
Description	Temporarily holds-off any ongoing command execution until communication is complete and ALLU is invoked.
Command syntax	NOTU
Query syntax	NOTU?
Query response	0 if not enabled non-zero when enabled
Other required commands	Disabled by ALLU .

NPPP

Number Pixels Per Pixel

Class Format parameter setting - Digital video signal

Description Specifies repetition factor for active portion of line.

Command syntax NPPP *factor*

factor

0 to disable repetition mode (removes extra left and right repetition bars)

1 to 10 enables pixel repetition mode (inserts extra left and right repetition bars)

Related commands [NCPP](#)

Example NPPP 4; FMTU

NSTP?

Number of STePs in sequence

Class Sequence editor control

Description Returns the number of steps in a sequence in the buffer.

Query syntax NSTP?

Query response steps

OERR?

ERRor queue Overflow

Class System memory management

Description Checks for overflow in the error queue. Overflow occurs when an attempt is made to add more errors to the queue than it can hold.

Query syntax OERR?

Query response overflow status
0 = No Overflow
1 = Overflow

OFFX

image OFFset X

Class	Image editor control
Description	Sets the horizontal offset used for the large patch in the Regulate test image. It may also control other images. The OFFX? query returns the current OFFX setting.
Command syntax	OFFX <i>x_offset</i> <i>x_offset integer</i> number of pixels
Query syntax	OFFX?
Query response	X offset
Example	OFFX 20

OFFY

image OFFsetY

Class	Image editor control
Description	Sets the vertical offset used for the large patch in the Regulate test image. It may also control other images. The OFFY? query returns the current OFFY setting.
Command syntax	OFFY <i>y_offset</i> <i>y_offset integer</i> number of pixels
Query syntax	OFFY?
Query response	Y offset
Example	OFFY 20

OUT1|OUT2|AV|VGA DCPG, DCPX?, DVSS, I2CR

Description See the following commands:

DCPG (OUT1:DCPG, OUT2:DCPG, AV:DCPG, VGA:DCPG)

DCPX? (OUT1:DCPX?, OUT2:DCPX, AV:DCPX?, VGA:DCPX?)

DVSS (OUT1:DVSS, OUT2:DVSS)

I2CR? (OUT1:I2CR?, OUT2:I2CR?, VGA:I2CR?)

OUTG

OUTputs Gate

Class	System parameter settings
Description	Gates all video and sync outputs of the generator ON and OFF. Gating the outputs OFF forces all outputs to be turned off. Gating the outputs ON turns on all outputs whose individual gating settings are turned ON. The OUTG? query returns the current status of the outputs of the generator.
Command syntax	OUTG <i>mode</i> <i>mode</i> 0 = OFF 1 = ON
Query syntax	OUTG?
Query response	<i>mode</i>
Example	OUTG 0 ALLU

OVAL

draw an OVAL

Class	Custom image primitive
Description	Draws an oval whose axes are parallel to the vertical and horizontal axes of displayed video. The size and position of the oval are defined by its framing rectangle. The framing rectangle is a rectangle whose sides are both tangent to the oval at four points and are parallel to the vertical and horizontal axis of video. It is not drawn as part of the primitive. OVAL uses six parameters. The first is <i>color</i> . The next two are the pixel <i>width</i> and <i>height</i> of the framing rectangle in pixels. The fourth and fifth parameters are the <i>x, y</i> coordinates for the top left corner of the framing rectangle. The last parameter is the <i>fill</i> .
Command syntax	<pre>OVAL <i>color width height x y fill</i></pre> <p><i>color</i> available colors</p> <p><i>width</i> total number of horizontal pixels</p> <p><i>height</i> total number of lines</p> <p><i>x, y</i> positive integer numbers</p> <p><i>fill</i> available fill patterns</p>
Other required commands	The FMTU command instructs the generator to use the new setting. The ALLU command updates hardware to the new setting and redraws the test image.
Example	<pre>OVAL red 240 150 20 10 GrayPat0 // Draw a red oval 240 pixels wide // by 150 pixels high. Start framing // rectangle at X=20, Y=10. // Fill = none</pre>

PAGE

draw PAGE of repeating characters

Class Custom image primitive

Description Fills a rectangular area (page or block) with a character that repeats horizontally and vertically. The *color* parameter sets the color used to draw the character. The *width* and *height* parameters determine the size of the block to be filled. The *x* and *y* parameters determine the top left corner of the block. The *font* parameter selects which font is used to draw the character. The *character* parameter selects a specific character (by number). For full alphanumeric fonts, the character number is the same as the character's ASCII code number. The spacing between the characters is fixed by the character block size in the font and cannot be changed. Partial characters are not drawn to completely fill the rectangular area; rather, the largest possible block of full characters is centered in the rectangular area.

Command syntax `PAGE color width height x y font character`

color

available colors

width

width of page in pixels

height

height of page in lines

x

position of left edge of page in pixels

y

position of top edge of page in pixels

font

available fonts

character

min = 0

max = 255

Example `PAGE blue 40 30 10 10 opix9 69`
`// Draw a small block of blue E characters in the upper left corner`

PCPG

Pixel Clock Pulse Gate

Class	Format parameter settings
Description	Enables and disables the pixel clock pulse output on generators that have a pixel clock output available. The pixel clock output appears on the special sync BNC connector. The PCPG? query returns the current setting of PCPG.
Command syntax	PCPG <i>mode</i> <i>mode</i> 0 = OFF 1 = ON
Query syntax	PCPG?
Query response	<i>mode</i>
Other required commands	FMTU or ALLU
Example	<pre>PCPG 1 // Enable pixel clk output in buffer FMTU // Update hardware with format data</pre>

PELD

PixEL Depth

Class	Format parameter settings
Description	Establishes the number of data bits that represent each active pixel in video memory (frame buffer). The PELD? query returns the current setting of PELD.
Command syntax	PELD <i>depth</i> <i>depth integer</i> 0 = use generator default 4 = 4 bits-per-pixel (16 colors) 8 = 8 bits-per-pixel (256 colors) 32 = 24 bits-per-pixel (16,777,216 colors)
Query syntax	PELD?
Query response	<i>depth</i>
Other required commands	The FMTU command instructs the generator to use the new setting. The ALLU command updates hardware to the new setting and redraws the test image.
Example	<pre>PELD 8 // Select 8 bits-per pixel ALLU // Configure hardware and redraw image</pre>

PENH

PEN Height

Class	Image editor control
Description	Sets a variable used establish line thicknesses to draw EeRise, NAWC, and Slider test images.
Command syntax	PENH <i>height</i> <i>height integer</i>
Query syntax	PENH?
Query response	<i>height</i>
Example	PENH 4

PENW

PEN Width

Class	Image editor control
Description	Sets a variable used to establish line thicknesses to draw EeRise, NAWC and Slider test images.
Command syntax	PENW <i>width</i> <i>width integer</i>
Query syntax	PENW?
Query response	<i>width</i>
Example	PENW 4

PREG

PRE-emphasis Gate

Class	Format parameter settings
Description	Enables and disables adding pre-emphasis to the Open LVDI digital outputs on generators that support LVDI outputs. The PREG? query returns the current setting of PREG. Pre-emphasis is used to add compensation for signal loss in long cables.
Command syntax	PREG <i>mode</i> <i>mode</i> 0 = Pre-emphasis OFF 1 = Pre-emphasis ON
Query syntax	PREG?
Query response	<i>mode</i>
Other required commands	FMTU or ALLU

PSHD

Probe Sync Pulse Horizontal Delay

Class Special Sync Probe Pulse

Description Sets the delay (in pixels) of the line(s) on which the probe pulse occurs on the special sync output. The PSHD? query returns the current PSHD value.

Command syntax PSHD *width*
width integer
 $0=PSVD(HTOT - PSPW-1)$

Query syntax PSHD?

Query response *width*

Other required commands The [FMTU](#) command instructs the generator to use the new settings. The [ALLU](#) command updates the hardware to the new settings and redraws the test image.

Related commands [PSPG](#), [PSPW](#), [PSPP](#), [PSVW](#), [PSPM](#)

```
Example PSPG 1 // Enables probe pulse on special sync
        PSPP 1 // Sets probe pulse polarity to positive
        PSPW 10 // Sets probe pulse width to 10 pixels
        PSHD 200 // Sets probe pulse horizontal delay to 200 pixels
        PSVD 300 // Sets probe pulse vertical delay to 300 pixels
        ALLU // Applies the settings
```

PSPG

Probe Sync Pulse Gate

Class	Special Sync Probe Pulse
Description	Enables and disables the probe pulse on the special sync output. The PSPG? query returns the current PSPG mode.
Command syntax	<code>PSPD <i>mode</i></code> <i>mode integer</i> 0 = OFF 1 = ON
Query syntax	PSPG?
Query response	0 or 1
Other required commands	The FMTU command instructs the generator to use the new settings. The ALLU command updates the hardware to the new settings and redraws the test image.
Related commands	PSPP , PSPW , PSHD , PSVW , PSPM
Example	<pre>FSPG 0 // Disables frame sync PSPG 1 // Enables probe pulse on special sync ALLU // Applies the settings</pre>

PSPM

Probe Sync Pulse Mode

Class	Special Sync Probe Pulse
Description	Determines what lines in the frame or field the probe pulse occurs on the special sync output. The <code>PSPM?</code> query returns the current PSPM value.
Command syntax	<code>PSPM mode</code> <i>mode integer</i> 0 = once per frame 1 = every active line in frame 3 = every line in frame 4 = custom pulse for specifying vertical pulse across multiple lines
Query syntax	<code>PSPM?</code>
Query response	0, 1, 3 or 4
Other required commands	The <code>FMTU</code> command instructs the generator to use the new settings. The <code>ALLU</code> command updates the hardware to the new settings and redraws the test image.
Related commands	PSPG , PSPP , PSPW , PSHD , PSVW

Example

```
PSPG 1 // Enables probe pulse on special sync
PSPP 1 // Sets probe pulse polarity to positive
PSPW 10 // Sets probe pulse width to 10 pixels
PSHD 200 // Sets probe pulse horizontal delay to 200 pixels
PSVD 300 // Sets probe pulse vertical delay to 300 pixels
PSPM 1 // Sets probe pulse to occur on each active line in a frame
ALLU // Applies the settings
```

PSPP

Probe Sync Pulse Polarity

Class	Special Sync Probe Pulse
Description	Sets the polarity of the probe pulse on the special sync output. The PSPG? query returns the current PSPP value.
Command syntax	PSPP <i>polarity</i> <i>polarity integer</i> 0 = negative 1 = positive
Query syntax	PSPP?
Query response	0 or 1
Other required commands	The FMTU command instructs the generator to use the new settings. The ALLU command updates the hardware to the new settings and redraws the test image.
Related commands	PSPG , PSPW , PSHD , PSVW , PSPM
Example	<pre>PSPG 1 // Enables probe pulse on special sync PSPP 1 // Sets probe pulse polarity to positive ALLU // Applies the settings</pre>

PSPW

Probe Sync Pulse Width

Class Special Sync Probe Pulse

Description Sets the width in pixels of the probe pulse on the special sync output. The PSPW? query returns the current PSPW value.

Command syntax PSPW *width*
width integer
1 pixel to (HTOT - 1))

Query syntax PSPW?

Query response *width*

Other required commands The [FMTU](#) command instructs the generator to use the new settings. The [ALLU](#) command updates the hardware to the new settings and redraws the test image.

Related commands [PSPG](#), [PSPP](#), [PSHD](#), [PSVW](#), [PSPM](#)

```
Example PSPG 1 // Enables probe pulse on special sync
        PSPP 1 // Sets probe pulse polarity to positive
        PSPW 100 // Sets probe pulse width to 100 pixels
        ALLU // Applies the settings
```

PSVD

Probe Sync Pulse Vertical Delay

Class Special Sync Probe Pulse

Description Sets the line in the frame or field that the probe pulse occurs on the special sync output. The PSVD? query returns the current PSVD value.

Command syntax PSVD *line*
line integer
0 = PSVD(VTOT-1)

Query syntax PSVD?

Query response *line*

Other required commands The [FMTU](#) command instructs the generator to use the new settings. The [ALLU](#) command updates the hardware to the new settings and redraws the test image.

Related commands [PSPG](#), [PSPW](#), [PSPP](#), [PSHD](#), [PSPM](#)

Example

```
PSPG 1 // Enables probe pulse on special sync
PSPP 1 // Sets probe pulse polarity to positive
PSPW 10 // Sets probe pulse width to 10 pixels
PSVD 300 // Sets probe pulse vertical delay to 300 pixels
ALLU // Applies the settings
```

PSVW

Probe Sync Pulse Vertical Width

Class Special Sync Probe Pulse

Description Sets the width in lines of the probe pulse on the special sync output. The PSVW? query returns the current PSVW value. To enable the setting of the pulse in number of lines you must specify custom for probe pulse mode (PSPM=4), the probe pulse horizontal delay to 0 (PSHD=0) and the horizontal pulse width (HSPW) to HTOT -1.

Command syntax PSVW *width*
width integer
1 line to (VTOT - 1))

Query syntax PSVW?

Query response *width*

Other required commands The [FMTU](#) command instructs the generator to use the new settings. The [ALLU](#) command updates the hardware to the new settings and redraws the test image.

Related commands [PSPG](#), [PSPP](#), [PSHD](#), [PSVW](#), [PSPM](#), [PSPW](#)

```
Example PSPG 1 // Enables probe pulse on special sync
        PSPP 1 // Sets probe pulse polarity to positive
        PSPM 4 // set pulse to custom to enable vertical length in lines
        PSHD 0 // set horizontal pulse delay to 0
        PSPW 639 // set horizontal pulse delay to HTOT-1
        PSVW 100 // Sets probe pulse vertical width to 100 lines
        ALLU // Applies the settings
```

PWD?

Print Working Directory

Class	Tools
Description	Lists the current directory.
Query syntax	PWD?
Query response	List of the directory
Related commands	None
Example	<pre>PWD? \tffs0\generator\images</pre>

PXAR?

Pixel Aspect Ratio Query

Class Format parameter setting - HDMI active video

Description Reads the aspect ratio of pixels in active regions of the raster image.

Query syntax PXAR?

Query response aspect ratio

Related commands [NCP](#)

Example PXAR?
+1.00000E+00

RATC

pixel RATE Calibration factor

Class	System parameter settings
Description	<p>Sets an internal multiplication factor used in setting the pixel clock frequency. The multiplication factor can be set to compensate for the frequency error of the internal reference crystal. Having to use a factor outside of the typical range may indicate a failure of generator's hardware. Reinitializing the generator's memory sets the calibration factor to a factory-default setting of 1.00000.</p> <p>Note: <i>The RATC parameter is a system level parameter that will affect the pixel clock frequency of all formats that are recalled. The RATC value will be retained when the generator is powered down and back up again. Query the current setting of RATC if you are experiencing problems with the pixel clock or scan rate being off in frequency.</i></p>
Command syntax	<p>RATC <i>factor</i></p> <p><i>factor</i></p> <p>floating point number equal to calibration factor</p> <p>typical min = 0.99990</p> <p>typical max = 1.00010</p>
Query syntax	RATC?
Query response	<i>factor</i>
Example	RATC 1.00007 // Increases pix clk by factor of 1.00007

RECT

draw a RECTangle

Class	Custom image primitive
Description	Draws a rectangle whose sides are parallel to the vertical and horizontal axes of displayed video. It uses six parameters. The first is the <i>color</i> of the line. The next two parameters are the pixel <i>width</i> and <i>height</i> of the rectangle. The fourth and fifth parameters are the <i>x</i> and <i>y</i> coordinates for the top left corner of the rectangle. The last parameter is the <i>fill</i> .
Command syntax	<pre>RECT <i>color width height x y fill</i></pre> <p><i>color</i> available colors</p> <p><i>width</i> total number of horizontal pixels</p> <p><i>height</i> total number of lines</p> <p><i>x, y</i> positive integer numbers</p> <p><i>fill</i> available fill patterns</p>
Other required commands	The FMTU command instructs the generator to use the new setting. The ALLU command updates hardware to the new setting and redraws the test image.
Example	<pre>RECT gray50 15 20 50 40 GrayPat50 // Draw a 50% gray rectangle 15 pixels wide and 20 pixels high // with top left corner at X=50, Y=40 Fill with 50% active pixels ALLU // Update hardware to current buffer contents</pre>

REDG

RED Gate

Class Video Gate

Description Toggles the red video signal gate.

Command syntax REDG *mode*
mode
0 = disable
1 = enable

Query syntax REDG?

Query response 0 or 1

Other required commands [ALLU](#) to invoke the command.

Related commands [BLUG](#), [GRNG](#)

Example REDG 0; ALLU // disable red video component

RFLD

Repeat Field

Class	Format parameter setting - Video resolution
Description	Determines if identical video information is output for each field of an interlaced (SCAN = 2) format. The RFLD? query returns the current setting of RFLD.
Command syntax	RFLD <i>mode</i> <i>mode</i> 0 = disabled 1 = enabled
Query syntax	RFLD?
Query response	0 or 1
Other required commands	FMTU or ALLU
Example	<pre>SCAN 2 // Set Interlaced scanning RFLD 1 // Enable repeat field buffer FMTU // Update hardware with format data</pre>

RGBW

RGB Write

Class LUT Management

Description Writes RGB levels to the slot location specified within the current lookup table buffer when a lookup table editing session is active, and writes the levels directly to the LUT hardware when a lookup table editing session is not active.

Command syntax *RGBW slot red_level green_level blue_level*
slot integer
0 to 15 when PELD = 4
0 to 255 when PELD = 8
red_level, green_level, blue_level integer
min = 0
max = LMAX setting (255 nominal)

Related commands

Example

```
IMGL RASTER
IMGU
SLUT 0 // clears the look up table
LINE RED 100 100 500 400 // creates red line
RECT GREEN 200 200 300 200 GRAYPAT100 // creates green rectangle
OVAL BLUE 200 200 100 100 GRAYPAT100 // creates blue oval
RGBW 1 255 255 0 // changes red line to yellow
RGBW 2 255 0 255 // changes green rect. to magenta
RGBW 3 0 255 255 // changes blue oval to cyan
```

RM

ReMove

Class Tools

Description Removes a file that resides in the current directory.

Command syntax `RM filename`

Command response *filename*
Any file in a generator or file server library directory.

Related commands None

Example `RM hello.o`

SAMP

Digital Audio Sinewave Amplitude

Class [Parameters \(Audio Signal and Timing\)](#)

Description Sets the amplitude in decibels of the audio stream sinewave output by the generator.

Command syntax `SAMP amplitude` (sets all channels)

amplitude

-96.3 to 0 (if [NBPA](#) is 16-bits)

-120.4 to 0.0 (if NBPA is 20-bits)

-144.5 to 0.0 (if NBPA is 24-bits)

Query syntax `SAMP?`

Query response *amplitude*

Example

```
SAMP -60.0           // Sets all channels to -60 amplitude
FMTU
```

Related commands [SRAT](#), [SMIN?](#), [SMAX?](#)

SCAL

Self CALibrate

Class System calibration setting

Description Causes a generator equipped with self-calibration circuitry to go through its self-calibration cycle.

Command syntax SCAL

SCAN

SCAN fields per frame

Class	Format parameter setting - Video resolution
Description	Establishes the number of fields scanned per frame. Set to 1 for progressive (non-interlaced) scan and 2 for interlaced scan. The SCAN? query returns the current setting of SCAN.
Command syntax	SCAN <i>fields</i> <i>fields</i> 1 = progressive (non-interlaced) 2 = interlaced
Query syntax	SCAN?
Query response	<i>fields</i>
Other required commands	The FMTU command instructs the generator to use the new setting. The ALLU command updates hardware to the new setting and redraws the test image.
Example	SCAN 2// Select interlace in buffer FMTU // Update hardware to current buffer contents

SDLY

Sequence step DeLaY

Class	Sequence editor control
Description	Sets how long a sequence step will pause before advancing to the next step in the auto run mode. A sequence step will use the last value set by the SDLY command. The SDLY? query returns the current setting of SDLY.
Command syntax	SDLY <i>delay</i> <i>-frames</i> <i>delay</i> Delay time in seconds as a floating point number. <i>frames</i> Delay in frames. Type minus (-) character before integer. min = 0.0 seconds; -1 frame max = 1.70E38 seconds (infinite)
Query syntax	SDLY?
Query response	<i>delay</i>
Other required commands	SMOD setting must be equal to 3 in order for the SDLY setting to have any affect on sequence operation.
Example	SDLY 5.0 // Set delay to five seconds per step SDLY -3 // Set delay to three frames per step

SDGM

Sonic Data Gate for SPDIF output

Class [Parameters \(Audio Signal and Timing\)](#)

Description Configures what audio (from what source) is transmitted out the SPDIF audio output port.

Note: *This command applies only to the 882EA.*

Command syntax SDGM *mask*

mask

0 = HDMI Rx - SPDIF OUT audio content is from the audio on the HDMI Rx port.

1 = SPDIF IN - SPDIF OUT audio content is from the audio received from the SPDIF Input.

2 = Internal - SPDIF OUT audio content is from the internal SPDIF audio generator.

Example 1 SDGM 2 // Causes the 882EA pass the SPDIF audio received from its SPDIF IN connector out through the SPDIF OUT connector.

Example 2 SDGM 1 // Causes the 882EA pass the SPDIF audio received from its HDMI IN connector out through the SPDIF OUT connector.

Example 3 SDGM 0 // Causes the 882EA pass the SPDIF audio received from its internal SPDIF generator out through the SPDIF OUT connector.

SDMG

Sonic Data Mixer Gate

Class [Parameters \(Audio Signal and Timing\)](#)

Description Configures the generator to use either an internal or external audio source for its HDMI audio output.

Note: Setting the mask “external” bit to 1 causes the SPDIF audio signal to be passed through the generator. In this case, the Audio InfoFrame CT, CC, SF, and SS parameters are set to 0, indicating that the stream header should be used to determine audio coding type, channel type, sampling frequency, and sample size, respectively. If both “external” and “sdg” bits are set to 1 simultaneously, then an error is generated as the generator’s sonic data mixer does not currently support proportional mixing of internal and external sources.

Command syntax SDMG *mask*

mask

1 = SDG is the internal sonic generator (internal) (Default)

2 = Passthrough from SPDIF IN port (external)

Example 1

```
SDMG 2 // causes the generator allow the SPDIF audio signal to be
        passed through to HDMI output
FMTU
```

SEOS

Set End Of String

Class GPIB port control

Description Controls how a generator reads strings, when reading multi-line responses. In GPIB communication both the sender and receiver first have to agree on end-of-string parsing. The SEOS command enables users to determine if the generator should use line feed for end-of-string parsing.

Command syntax SEOS *integer*

integer

0 = Configures the generator to not test end-of-strings, and to send EOI only on the last character of the entire response. Use this option to receive an entire multi-line response in a single read operation. Leave the VISA "Enable Termination Character" option set to FALSE.

1 = Use end-of-string testing (default).

Query syntax SEOS?

SEQA

SEQUence save As

Class Sequence memory management

Description Saves the current contents of the sequence edit buffer using the given name.

Command syntax `SEQA name`

name

A valid MS-DOS filename (8 characters minus any extension)

Example `SEQA MY_SEQ // Save with the name "MY_SEQ"`

SEQB

SEQuence editing Begin

Class	Sequence editor control
Description	Marks the beginning of a sequence editing session.
Command syntax	SEQB
Other required commands	Use either a SEQL command to load an existing sequence or a SEQN command to create a new sequence. Use SEQE when ending the editing session.
Example	<pre>SEQN // Initialize sequence edit buffer SEQB // Start sequence editing session // One or more sequence editing commands ... SEQE // End sequence editing session</pre>

SEQE

SEQuence editing End

Class Sequence editor control

Description Marks the end of a sequence editing session.

Command syntax SEQE

Other required commands Use [SEQB](#) when starting the editing session. Use [SEQA](#) or [SEQS](#) to save changes.

```
Example EQB           // Start sequence editing session

           // One or more sequence editing commands ...

SEQE           // End sequence editing session
SEQA MYSEQ_02 // Save edited sequence as "MYSEQ_02"
```

SEQK

SEQuence Kill

Class Sequence memory management

Description Deletes a sequence by name. The query returns a 1 if the named sequence can be deleted. If sequence is read-only or non-existent, the query returns a 0.

Command syntax SEQK *name*
name
a valid MS-DOS filename (8 characters minus any extension)

Query syntax SEQK? *name*
name
a valid MS-DOS filename (8 characters minus any extension)

Query response 0 or 1

Example SEQK MY_SEQ // Delete seq called "MY_SEQ"

SEQL

SEQuence Load

Class	Sequence memory management
Description	Copies the sequence having a name equal to <i>name</i> from sequence memory into the sequence edit buffer. The query returns a 1 if the named sequence can be loaded; otherwise, a 0 is returned.
Command syntax	SEQL <i>name</i> <i>name</i> a valid MS-DOS filename (8 characters minus any extension)
Query syntax	SEQL? <i>name</i> <i>name</i> a valid MS-DOS filename (8 characters minus any extension)
Query response	0 or 1
Other required commands	An SEQU command must be executed after the SEQL command to start running the sequence.
Example	<pre>SEQL MY_SEQ // Load "MY_SEQ" dir in edit buffer SEQU // Start running the sequence in the buffer</pre>

SEQN

SEquence New

Class	Sequence editor control
Description	Initializes the sequence edit buffer. The name <i>name</i> is assigned as the sequence's name. The query will return the name that has been assigned as the sequence's name.
Command syntax	SEQN <i>name</i> <i>name</i> optional valid MS-DOS filename (8 characters minus any extension)
Query syntax	SEQN?
Query response	<i>name</i>
Example	<pre>SEQN // Init edit buffer without assigning a new name or SEQN MY_SEQ // Init edit buffer with name of "MY_SEQ"</pre>

SEQP

SEquence Path

Class	Sequence memory management
Description	Sets the current sequence path name to a given directory. The query will return the current path name.
Command syntax	SEQP <i>name</i> <i>name</i> a valid MS-DOS filename (8 characters minus any extension)
Query syntax	SEQP?
Query response	Current sequence path name.
Example	SEQP BURN // Sequences in BURN directory will be listed

SEQQ?

SEQuence Query pointer

Class	Sequence memory management
Description	Returns number sequence names from the list of all the sequence names stored in sequence memory beginning at <i>index</i> . The directories are kept in alphanumeric order. The generator maintains internal variables for the current <i>index</i> and <i>number</i> values. The value of <i>index</i> is automatically incremented by <i>number</i> after the query is executed. Sending the query with just an <i>index</i> parameter, will return the same number of names as the last time, starting at the given index. Sending the query with no parameters will return the next set of names in the directory buffer.
Query syntax	SEQQ? <i>index number</i> <i>index</i> positive integer number <i>number</i> positive integer number
Query response	List of specified sequence names.

Example 1 SEQQ? 1 9999 // List the names of all sequences stored in memory

Example 2 SEQQ? 1 10 // List names of the first ten sequences stored in memory
SEQQ? 21 // List names of the 21st through the 30th sequences
SEQQ? // List names of the 31st through the 40th sequences

SEQS

SEQUence Save

Class Sequence memory management

Description Saves the current contents of the generator's sequence edit buffer back to the memory location from which they were originally read.

Command syntax SEQS

SEQU

SEquence Use

Class	Sequence memory management
Description	Runs the sequence currently stored in the sequence edit buffer. The SEQU? query returns the sequence name currently set in the sequence edit buffer.
Command syntax	SEQU
Query syntax	SEQU?
Query response	name
Other required commands	The sequence in the edit buffer must have a non-zero SMOD setting to run.
Example	<pre>SEQL MY_SEQ // Load "MY_SEQ" dir in edit buffer SEQU // Start running the sequence in the buffer</pre>

SLUT

Set Look-Up Table

Class LUT Management

Description Sets up the color look-up-table (LUT) for rendering and displaying selected colors from defined sets. This command is made available for testing low-level drawing firmware and is not intended for use by end users.

Command syntax `SLUT colorset`
`colorset integer`
Bit mask indicating desired color sets

Example 1 `SLUT 65536 // Setup for HUERGB colorset`

Example 2 `SLUT 0 // clears look up table`

SMAX?

Digital Audio Sinewave Maximum

Class [Parameters \(Audio Signal and Timing\)](#)

Description Returns the maximum amplitude of the digital audio sinewave output from the generator.

Query syntax SMAX?

Query response maximum amplitude (0 - 65,535)

Related commands [SRAT](#), [SAMP](#), [SMIN?](#)

SMIN?

Digital Audio Sinewave Minimum

Class [Parameters \(Audio Signal and Timing\)](#)

Description Returns the minimum amplitude of the digital audio sinewave output from the generator.

Query syntax SMIN?

Query response minimum amplitude (0 - 65,535)

Related commands [SRAT](#), [SAMP](#), [SMAX?](#)

SMOD

Sequence operating MODE

Class	Sequence editor control
Description	Sets the sequence mode. The SMOD? query returns the current setting of SMOD.
Command syntax	SMOD <i>mode</i> <i>mode</i> 0 = disable 1 = enable manual step mode that stops at last step 2 = enable manual step mode that wraps to first step after last step 3 = enable continuous auto stepping
Query syntax	SMOD?
Query response	<i>mode</i>
Other required commands	The SEQL command loads the sequence and SEQU starts to run it.
Example	<pre>SEQL MY_SEQ // Load "MY_SEQ" in edit buffer SEQU // Start running the sequence in the buffer SMOD 3 // Set the sequence mode</pre>

SNUM

draw sequence Step NUMBER

Class	Custom image primitive
Description	Displays the sequence step number to an image when drawn as part of a test sequence. The number, along with the word “Step,” appears in a small box. The SNUM command uses three parameters. The first is the <i>color</i> used for the text and box border. The next two parameters are the <i>x</i> and <i>y</i> coordinates for the position of the box.
Command syntax	<pre>SNUM <i>color</i> <i>x</i> <i>y</i></pre> <p><i>color</i> available colors</p> <p><i>x, y</i> positive integer numbers</p>
Other required commands	The displaying of sequence step numbers must be enabled with the DNUM command, and the custom image must have been loaded as part of a sequence in order for this primitive to be drawn.
Example	<pre>SNUM white 50 50 // Display seq. num. in box with top left corner at // X=50, Y=50</pre>

SPAX

slider image SPACING X

Class	Image editor control
Description	Sets the horizontal spacing of certain elements in some built-in test images. The SPAX? query returns the current SPAX setting.
Command syntax	SPAX <i>x_spacing</i> <i>x_spacing integer</i> number of pixels
Query syntax	SPAX?
Query response	<i>x_spacing</i>
Example	SPAX 20

SPAY

slider image SPACING Y

Class	Image editor control
Description	Sets the vertical spacing of certain elements in some built-in test images. The SPAY? query returns the current SPAY setting.
Command syntax	SPAY <i>y_spacing</i> <i>y_spacing integer</i> number of pixels
Query syntax	SPAY?
Query response	<i>y_spacing</i>
Example	SPAY 20

SRAT

Digital Audio Sinewave Rate

Class [Parameters \(Audio Signal and Timing\)](#)

Description Sets the frequency of the audio sinewave from the generator.

Command syntax SRAT *rate*
rate
20.0 to 20.0E3 (Hz)

Query syntax SRAT?

Query response *rate*

Example SRAT 10.0E3
FMTU

Related commands [SAMP](#), [SMAX?](#), [SMIN?](#)

SSST

Select Sync Signal Type

Class	Format parameter setting - Synchronization
Description	Selects the type of sync signal used to synchronize the display. In general, any one of three different types of sync can be selected to synchronize the display. The availability of different sync types is specified using the ASCT, DSCT, and DSST commands. Some displays may not accept one (or more) types of sync. For example, a digital video monitor cannot accept analog composite sync because analog signal transmission is not used. Also, a PGA display cannot accept digital separate HS and VS because only one sync wire is provided in the cabling. In these cases, one (or more) of the sync types (ASCT, DSCT, or DSST) is set to 0, indicating that they are not supported. If a non-supported sync type is selected using the SSST command, then the corresponding sync outputs of the generator will remain disabled. The SSST? query returns the type of sync (if any) that is currently selected.
Command syntax	SSST <i>type</i> <i>type</i> 0 = no sync 1 = digital separate horizontal and vertical sync (DHS & DVS) 2 = digital separate sync (DSS) 3 = digital separate composite sync (DCS) 4 = analog composite sync (ACS) 5 = DSS and ACS 6 = DCS and ACS 7 = DSS, DCS, and ACS 8 = DPMS-OFF (DSS) 9 = DPMS-SUSPEND (DSS) 10 = DPMS-STANDBY (DSS) 11 = DCS & DSS
Query syntax	SSST?
Query response	<i>type</i>

Other required commands The desired sync type selected must not be set to void with the [ASCT](#), [DSCT](#), or [DSST](#) commands. To actually output the selected sync signal, it must be gated on with the appropriate [ASSG](#), [ASBG](#), [ASGG](#), [ASRG](#), [CSPG](#), [HSPG](#), and [VSPG](#) settings.

Example

```
DSST 1 // Set Amer. H&V in buffer
HSPG 1 // Enable H sync in buffer
VSPG 1 // Enable V sync in buffer
SSST 1 // Select sep H&V sync in buffer
FMTU // Update hardware to current buffer contents
```

STRG

STRetchinG SCL Low Signal

Class EDID and DDC control

Description Enables a stretching capability for the receiver of the HDMI analyzer. Each time a host accesses the I2C receiver bus (for example, to read the EDID), the receiver stretches the SCL low signal for 5 ms.

Enable stretching for testing purposes only.

Command syntax STRG *value*

value

0 = deactivate stretching

1 = activate stretching of SCL low signal for 5 ms

Query syntax STRG?

Query response 0 or 1

Example STRG 1
DIDU

Related commands

STEP

sequence STEP number

Class	Sequence editor control
Description	<p>Selects a step in the sequence edit buffer. It is context sensitive. While editing a sequence (between SEQB and SEQE commands), the STEP command selects a step to be edited. Outside of the sequence editor and while running a sequence, the command selects a step to be executed.</p> <p>The STEP? query returns the current setting of STEP.</p>
Command syntax	<p>STEP <i>step</i></p> <p><i>step</i></p> <p>min = 1</p> <p>max = See description</p>
Query syntax	STEP?
Query response	<i>step</i>
Other required commands	When running a sequence, the SEQU command must be executed after the STEP command to load the format and display the image selected in the step.
Example	<pre>STEP 5 // Select fifth step in current sequence SEQU // Load format and draw image in current step</pre>

SVSG

Single Video Signal Gating

Class Video Gate

Description Determines which output colors are enabled. The SVSG? query returns the current SVSG setting.

Command syntax SVSG *gate_mask*
gate_mask

Gate Mask	Red	Green	Blue
0	Off	Off	Off
1	Off	Off	On
2	Off	On	Off
3	Off	On	On
4	On	Off	Off
5	On	Off	On
6	On	On	Off
7	On	On	On

Query syntax SVSG?

Query response *gate_mask*

Example SVSG 7

SXAR

Signal Aspect Ratio

Class Format parameter setting - active video

Description Sets the natural aspect ratio of the video signal format (or “coded frame”) that transports images to the display.

Command syntax `SXAR aspect_ratio`
`aspect_ratio`
0.75 to ~2.39

Note: For a listing of established aspect ratios, see the table on page 530 (CXAR command).

Related commands [CXAR](#), [EXAR](#)

Example `SXAR 1.33 // Sets 4:3 video signal aspect ratio for source content`
`FMTU`

SXCX

Signal-From-Content Aperture Map

Class Format parameter setting - active video

Description Sets the proper parameters to values necessary to fit CXAR-shaped image content to the SXAR-shaped aperture of the signal interface timing format.

Upon executing this command, the following actions are performed:

1. The EXAR value is set to the CXAR value (EXAR=CXAR).
2. The EXCX value is set to 0 (EXCX=0).
3. The SXEX value is set to value entered for this command (SXEX=SXCX).

Command syntax SXCX *code*

code

0 to 131071 (in decimal)

Note: For help in determining the proper mapping code, follow the procedure on page 606 ([EXCX](#) command).

Related commands [SXEX](#), [EXAR](#), [EXCX](#), [CXAR](#), [SXCX](#), [SXAR](#)

Example SXCX 264 //Use centered shrink w/black bars top & bottom
FMTU

SXEX

Signal-From-Extended Aperture Map

Class Format parameter setting - active video

Description Maps EXAR-shaped image content into the SXAR-shaped signal interface.

Command syntax SXEX *code*

code

0 to 131071 (in decimal)

The mapping code is made up of three binary field codes as follows:

- Bits 0-2 are the *Squeeze/Stretch* (“S”) field code
- Bits 3-9 are the *Letterbox/Pillar* (“L”) field code
- Bits 10-16 are the *Safe Area* (“K”) field code

Note: For help in determining the proper mapping code, follow the procedure on page 606 ([EXCX](#) command).

Related commands [EXAR](#), [SXAR](#), [EXCX](#), [SXCX](#)

Example SXEX 264 //Use centered shrink w/black bars top & bottom
FMTU

TASK?

TASK?

Class Tools

Description Lists the current tasks.

Query syntax TASK?

Query response Tabular list of tasks

Related commands None

Example TASK?

NAME	ENTRY	TID	PRI	STATUS	PC	SP	ERRNO	DELAY
tExcTask	excTask	f549d8	0	PEND	415e84	f548f8	0	0
tLogTask	logTask	f52050	0	PEND	415e84	f51f78	0	0
tDcacheUpd	dcacheUpd	f2d7d0	1	READY	39fd44	f2d748	3006c	0
tCShell	1849d0	e393a8	1	PEND	39ba74	e38eb8	0	0
tCShell0	1849d0	d2b5f8	1	READY	3a0780	d2b100	0	0
tPcmciad	pcmciad	f50550	2	PEND	415e84	f50470	0	0
tWdbTask	392880	e3b6e0	3	PEND	39ba74	e3b5f8	0	0
tSerRxTx	RxTxTaskEntr	d95580	7	READY	39fd44	d954f8	0	0
cioPipeDraiDrainPipe__8		ffeb98	8	PEND	39ba74	ffea38	3d0002	0
appMain	appMain__Fv	da5798	10	READY	39fd44	da55e0	0	0
tNetTask	netTask	e69e28	50	READY	39ba74	e69d70	0	0
tWebUI	AcceptTaskEn	d77088	50	PEND	39ba74	d76ef0	0	0
tTelnetd	telnetd	e40fa8	55	PEND	39ba74	e40e08	0	0
tFtpdTask	1c890c	e3f9b8	55	PEND	39ba74	e3f850	0	0
GPIB	MonitorEntry	d8db68	55	READY	39c170	d8dac8	3d0004	0
tTelnetOutTtelnetOutTas		d265c0	55	READY	39ba74	d262e8	0	0
tTelnetInTatelnetInTask		d25020	55	READY	39b8d0	d24cf8	0	0
tSeqTask	RunEntry__15	d71db8	90	PEND	39ba74	d71d00	0	0
tTffsPTask	flPollTask	f2a268	100	READY	39fd44	f2a1e0	0	0
tPortmapd	portmapd	e42570	100	PEND	39ba74	e423f0	16	0
tHTTPd	3dac04	e22ee0	200	PEND	39ba74	e22da8	0	0

value = 0 = 0x0

TBOX

draw information Text BOX

Class	Custom Image Primitive
Description	Renders an information text box that can be added to custom images. This command allows color, position, information, and box type to be customized.
Command syntax	<p>TBOX <i>color %x %y info type</i></p> <p><i>color</i> valid color name</p> <p><i>%x</i> 0.0 to 1.0 normalized positioning of box center in the x direction</p> <p><i>%y</i> 0.0 to 1.0 normalized positioning of box center in the y direction</p> <p><i>info</i> 0 = format, image, line-rate, and frame-rate (default = 1 = format 2 = image 3 = sequence 4 = step number 5 = format and image 6 = sequence and step 7 = line-rate and HRES X VRES 8 = pixel-rate and HRES X VRES 9 = format, image, sequence, and step 10 = format, image, HRES X VRES, and pixel rate 11 = line-rate, frame-rate, sequence, and step 12 = pixel-rate, HRES X VRES, sequence, and step 13 = line-rate, frame-rate, pixel-rate, and HRES X VRES 14 = format, image, line-rate, frame-rate, sequence, and step 15 = format, image, HRES X VRES, pixel-rate, sequence and step</p>

type

0 = text only

1 = text w/ border

2 = text w/ black background

3 = text w/ border and black background

Query syntax `TBOX?`

Query response `color %x %y info type`

Other required
commands `TBXG`

Example `TBOX white 0.5 0.5 8 3`

TBXG

Text BoX Gating

Class

Description Enables and disables the displaying of the text box defined by the TBOX command. The TBXG? query returns the current TBXG mode.

Command syntax TBXG *mode*
mode integer
0 = OFF
1 = ON

Query syntax TBXG?

Query response *mode*

Other required commands [TBOX](#)

Example TBXG 1

TIME

TIME

Class System parameter setting

Description Sets the system time in the 882.

Command syntax TIME *hh mm ss*

hh

00 - 23

mm

00 - 59

ss

00 - 59

Query syntax TIME?

hh:mm:ss

Example 1 TIME 13 44 48

Example 2 TIME?
13:44:48

Related commands [DATE](#)

TEXT

draw TEXT string

Class	Custom image primitive
Description	<p>Draws a user-defined text string. It uses five parameters. The first is <i>color</i>. The next two are the <i>x</i> and <i>y</i> coordinates for the upper left corner of the starting position of the string. The fourth parameter selects the <i>font</i>. The last parameter is the <i>text</i> string. If the string is longer than one word, it must be contained inside quotation marks.</p> <p>All of the characters in the text string must have matching characters in the font selected by font name.</p>
Command syntax	<p>Text <i>color x y font "text "</i></p> <p><i>color</i> available colors</p> <p><i>x, y</i> coordinates of top left corner of page in pixels</p> <p><i>font</i> available fonts</p> <p><i>text</i> approximately 30 characters (must be enclosed by quotes)</p>
Other required commands	The FMTU command instructs the generator to use the new setting. The ALLU command updates hardware to the new setting and redraws the test image.
Example	<pre>TEXT red 50 40 opix9 "HELLO WORLD" // Draw red "HELLO WORLD" at x=50 y=40 in opix9 font</pre>

TOBL

set levels relative TO BLanking

Class Custom image primitive

Description Temporarily changes how the signal levels are determined for a given color intensity level. The default method uses black as the 0% reference level and peak video as the 100% level. Inserting TOBL moves the 0% reference point to the blanking (blacker than black) pedestal level. The reference point remains shifted only for as long as the image is displayed.

Command syntax TOBL

TOGG

TOGGle Hot Plug (enable/disable)

Class	System
Description	Enables or disables reading EDID from sink to set the Source list to hot plug formats. When enabled, only EDID formats will be shown in the Source list.
Command syntax	<p>TOGG <i>mode</i></p> <p><i>mode</i></p> <p><i>1</i></p> <p>Enable reading of EDID from sink. This is equivalent to pressing the Sink->Options key sequence and enabling EDID formats.</p> <p><i>0</i></p> <p>Disable read of EDID from sink. This is equivalent to pressing the Sink->Options key sequence and disabling EDID formats.</p>
Query syntax	TOGG?
Query response	<i>mode</i>
Example	<pre>TOGG 0 // disables EDID formats TOGG 1 // enables EDID formats</pre>

TRIA

draw a TRIAngle

Class Custom image primitive

Description Draws a triangle defined by its three end points. The primitive uses eight parameters. The first is line *color*. The next three pairs of parameters are the *x* and *y* coordinates for the three points. The last parameter is the *fill*. More complex filled polygons can be built up using a series of joined filled triangles.

Command syntax `TRIA color x1 y1 x2 y2 x3 y3 fill`

color

available colors

x1, *y1*, *x2*, *y2*, *x3*, *y3*

positive integer number

fill

available fill pattern

Other required commands The [FMTU](#) command instructs the generator to use the new setting. The [ALLU](#) command updates hardware to the new setting and redraws the test image.

```
Example TRIA red50 10 5 10 25 40 15 GrayPat50
        // Draw a red50 triangle at x=10,
        // y=5; x=10, y=25; x=40, y=15 with
        // 50% active pixel fill

        ALLU // Update hardware to current
        // buffer contents
```

TSPG

Tri-level Sync Pulse Gate

Class Format parameter setting - Synchronization

Description Enables and disables the tri-level sync pulse. This command affects only tri-level analog composite sync types (ASCT = 1, 11, 12, 13, 14, or 15). The exact function of the TSPG command depends on the analog sync composite type selected, as shown below.

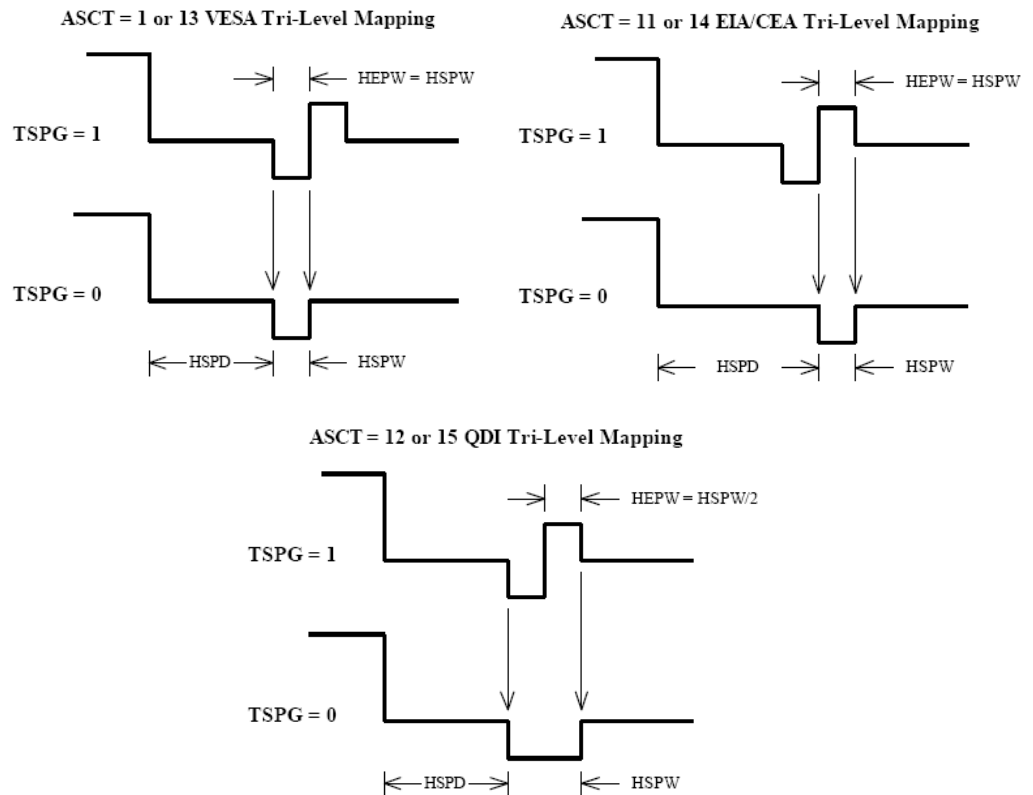

Command syntax TSPG *mode*

mode

0 = OFF

1 = ON

Query syntax TSPG?

Query response *mode*

Other required commands The **FMTU** command instructs the generator to use the new setting. The **ALLU** command updates hardware to the new setting and redraws the test image.

Example TSPG 1 // Enable tri-level sync pulse in buffer
 FMTU // Update hardware to current buffer contents

UI:MODE

Operational mode

Class	System control
Description	Sets generator operational mode
Command Syntax	UI:MODE <i>mode</i> <i>mode</i> 0 = Basic mode 1 = Browse mode
Query syntax	UI:MODE?
Query response	<i>mode</i>
Example	UI:MODE 1 // Set operational mode to Browse mode

UIDN

User IDeNtification

Class	System parameter settings
Description	Sets up the text string that is placed in the upper portions of the SMPTE133 and Cubes images. The command can be used to add a company name or other identification to the images. The command will not change the text in a currently displayed image; it must be redrawn to use the new text. The factory default string is "Quantum Data." The UIDN? query returns the current text string.
Command syntax	UIDN <i>string</i> <i>string</i> text string 80 characters in length
Query syntax	UIDN?
Query response	<i>string</i>
Other required commands	The IMGU command redraws the last selected test image. The ALLU command updates hardware to the new setting and redraws the test image.
Example	<pre>UIDN "XYZ Monitor Mfg." // Change text string IMGL SMPTE133 // Select image that uses the text string IMGU // Draw the image using new string</pre>

USIZ

Unit of measure used for physical SIZES

Class	System control
Description	<p>Sets the units of measure assumed by HSIZ and VSIZ commands to establish the physical size of the image that appears on the CRT (context sensitive; see FMTB and FMTE). The <code>USIZ?</code> query returns the current setting of <code>USIZ</code>.</p> <p>Note: Changing the <code>USIZ</code> parameter between inches and millimeters will convert the current <code>HSIZ</code> and <code>VSIZ</code> values to match the new unit of measure. For example, if <code>USIZ</code> is in inches and the current <code>HSIZ</code> is 10 (inches), changing <code>USIZ</code> from inches to mm will change <code>HSIZ</code> to 25.4 (mm). The <code>USIZ</code> command should be sent before specifying physical sizes in format command files.</p>
Command syntax	<p><code>USIZ units</code></p> <p><i>units</i></p> <ul style="list-style-type: none">0 = sizes not given (use default)1 = inches2 = mm
Query syntax	<code>USIZ?</code>
Query response	<i>units</i>
Other required commands	The ALLU command updates hardware to the new setting and redraws the test image, taking the new units into account.

```
Example FMTB      // Begin editing session
        // One or more format editing commands ...
        USIZ 1    // Select inches as unit of measure in buffer
        HSIZ 10.4 // Set width to 10.4 in buffer
        VSIZ 7.8  // Set height to 7.8 in buffer
        ALLU      // Test the new settings
        // One or more format editing commands ...
        FMTE      // End editing session
```

USRA

Add USeR

Class Tools

Description Adds a user profile.

Command syntax USRA *username*

username

A name with 8 alphanumeric characters.

Example USRA janedoe
USRU janedoe

USRK

Delete a USeR

Class Tools

Description Deletes a user profile.

Command syntax USRK *username*
username
An existing user name

Example USRK janedoe

USRU

Create USeR

Class	Tools
Description	Creates a user profile.
Command syntax	USRU <i>username</i> <i>username</i> A name with 8 alphanumeric characters.
Query syntax	USRU?
Query response	<i>username</i>
Example	USRA janedoe USRU janedoe

VERF?

VERsion Firmware

Class Miscellaneous system parameters

Description Returns the firmware version number for the runtime code and the boot code. The digits to the left of the decimal point represent the major release level. The digits to the right of the decimal point represent the revision number of the release. A second decimal point followed by more digits indicates the revision is at a given beta test level.

Query syntax VERF?

Query response *version runtime code: version boot code*

Example VERF?
20.0882002,01.03.03

VERG?

VERsion Gateware

Class Miscellaneous system parameters

Description Returns the gateware version number for the programmable devices. The digits to the left of the decimal point represent the major release level. The digits to the right of the decimal point represent the revision number of the release. A second decimal point followed by more digits indicates the revision is at a given beta test level.

Query syntax VERG?

Query response *product code, revision, date code: product code, revision, date code: product code, revision, date code*

Example VERG?
255C, 39, 3232006:253F, 75, 4252006:253A, 7, 4252006

VRAT?

Vertical RATE Query

Class Format parameter setting - Video resolution

Description Returns the current vertical (field) rate. This is equal to the product of the FRAT (frame rate) and SCAN (scan type) settings (FRAT * SCAN).

Query syntax VRAT?

Query response vertical field rate

Example VRAT? //read the product of FRAT and SCAN settings
50.0000

Related commands [FRAT?](#)

VRES

Vertical RESolution

Class	Format parameter setting - Video resolution
Description	Establishes the number of active lines per frame. The VRES? query returns the current setting of VRES.
Command syntax	<p>VRES <i>lines</i></p> <p><i>lines</i></p> <p>min =</p> <ul style="list-style-type: none">• 1 (when SCAN = 1) or• 2 (when SCAN = 2) <p>max = the lesser of</p> <ul style="list-style-type: none">• VTOT-1 (when SCAN = 1) or• VTOT-3 (when SCAN = 2) <p>Must be an even number when SCAN = 2.</p>
Query syntax	VRES?
Query response	<i>lines</i>
Other required commands	The ALLU command updates hardware to the new setting and redraws the test image.
Example	<pre>VRES 480 // Set 480 active lines in buffer ALLU // Configure hardware and redraw image</pre>

VSIZ

Vertical SIZE

Class	Format parameter setting - Video resolution
Description	<p>Establishes the vertical physical size of the image on the display. Units expected (or returned) vary according to the last mode set with USIZ command. The VSIZ command is context sensitive and must appear between begin and end commands FMTB and FMTE. The VSIZ? query returns the current setting of VSIZ.</p> <p>Note: Make sure that the USIZ parameter is properly set before using the VSIZ command. Changing the USIZ setting after entering VSIZ will convert the size to match the new unit of measure.</p>
Command syntax	<p>VSIZ <i>size</i></p> <p><i>size</i> physical size; positive value (floating point accepted)</p>
Query syntax	VSIZ?
Query response	<i>size</i>
Other required commands	The units of measure must be properly set by USIZ before entering VSIZ. The ALLU command updates hardware to the new setting and redraws the test image, taking the new size into account.
Example	<pre>FMTB // Begin editing session // One or more format editing commands ... USIZ 1 // Select inches as unit of measure in buffer HSIZ 10.4 // Set width to 10.4 in buffer VSIZ 7.8 // Set height to 7.8 in buffer ALLU // Test the new settings // One or more format editing commands ... FMTE // End editing session</pre>

VSPD

Vertical Sync Pulse Delay

Class	Format parameter setting - Synchronization
Description	Establishes the delay between leading edge of blanking in the first (or even) field and the leading edge of the vertical sync pulse. When interlacing, delay between end of video and leading edge of vertical sync before second (or odd) field is 0.5 line shorter than the whole-line delay specified. The VSPD? query returns the current setting of the vertical sync pulse delay.
Command syntax	VSPD <i>lines</i> <i>lines</i> min = 0 (when SCAN = 1) or 1 (when SCAN = 2) max = VTOT-VRES-VSPW (when SCAN = 1) or [(VTOT-VRES-1) /2]-VSPW (when SCAN = 2)
Query syntax	VSPD?
Query response	<i>lines</i>
Other required commands	The FMTU command instructs the generator to use the new setting. The ALLU command updates hardware to the new setting and redraws the test image.
Example	<pre>VSPD 11 // Set V sync delay to 11 lines in buffer FMTU // Update hardware to current buffer contents</pre>

VSPG

Vertical Sync Pulse Gate

Class	Format parameter setting - Synchronization
Description	Enables and disables the digital vertical sync output. The VSPG? query returns the current mode of VSPG.
Command syntax	<pre>VSPG <i>mode</i> <i>mode</i> 0 = OFF 1 = ON</pre>
Query syntax	VSPG?
Query response	0 or 1
Other required commands	To use digital vertical sync, digital separate H and V sync must be selected with the SSST command. The FMTU command instructs the generator to use the new setting. The ALLU command updates hardware to the new setting and redraws the test image.
Example	<pre>VSPG 1 // Enable V sync output in buffer FMTU // Update hardware to current buffer contents</pre>

VSPP

Vertical Sync Pulse Polarity

Class	Format parameter setting - Synchronization
Description	Establishes the logic sense of the digital vertical sync outputs. Setting polarity to 1 causes the leading edge of vertical sync to be a low-to-high transition. Setting polarity to 0 causes the leading edge of vertical sync to be a high-to-low transition. The VSPP? query returns the current polarity of VSPP.
Command syntax	<i>VSPP polarity</i> <i>polarity</i> 0 = high-to-low transition 1 = low-to-high transition
Query syntax	VSPP?
Query response	0 or 1
Other required commands	In order to use digital vertical sync, it must be gated on with the VSPG command and digital separate H and V sync must be selected with the SSST command. The FMTU command instructs the generator to use the new setting. The ALLU command updates hardware to the new setting and redraws the test image.
Example	<pre>VSPP 1 // Set active hi V sync in buffer VSPG 1 // Enable V sync output in buffer SSST 1 // Select H&V sync type in buffer FMTU // Update hardware to current buffer contents</pre>

VSPW

Vertical Sync Pulse Width

Class	Format parameter setting - Synchronization
Description	Establishes the width of the vertical sync pulse in lines. If the type specified for the selected sync signal (see SSST , ASCT , DSCT , or DSST commands) is one of the CCIR types, then the actual sync pulse width output by the generator will be 1/2 line shorter than the whole number specified. The <code>VSPW?</code> query returns the current setting of VSPW.
Command syntax	<code>VSPW <i>lines</i></code>
Query syntax	<code>VSPW?</code>
Query response	<i>lines</i>
Other required commands	The FMTU command instructs the generator to use the new setting. The ALLU command updates hardware to the new setting and redraws the test image.
Example	<pre>VSPW 3 // Set V sync width to 3 lines in buffer FMTU // Update hardware to current buffer contents</pre>

VTOT

Vertical TOTal lines per frame

Class Format parameter setting - Video resolution

Description Establishes the total number of lines per frame. When interlacing (SCAN=2), VTOT must be odd. The VTOT? query returns the current setting of VTOT.

The frame or picture refresh rate is equal to HRAT divided by VTOT.

The field or vertical rate is equal to the frame rate when SCAN = 1 (non-interlaced operation).

The field or vertical rate is equal to twice the frame rate when SCAN = 2 (non-interlaced operation).

Note: The current version of the firmware does not allow you to directly enter a specific field or frame rate when setting up a format. If your test specifications call for a specific field, frame or vertical refresh rate, enter suitable values for HRAT, SCAN and VTOT to give you the desired rate.

Command syntax VTOT *lines*

lines

must be an odd number when SCAN = 2

min =

- 2 @ SCAN=1
- 5 @ SCAN=2

max =

- 801GC-ISA = 4096 @ SCAN=1; 4097 @ SCAN=2
- 801GF-ISA = 4096 @ SCAN=1; 8191 @ SCAN=2
- 801GP = 2048
- 801GC, GX = 4096 @ SCAN=1; 4097 @ SCAN=2
- 801GF = 4096 @ SCAN=1; 8191 @ SCAN=2

Query syntax VTOT?

Query response *lines*

Other required commands The **FMTU** command instructs the generator to use the new setting. The **ALLU** command updates hardware to the new setting and redraws the test image.

Example VTOT 525 // Set total lines//frame to 525 in buffer
 FMTU // Update hardware to current buffer contents

XISH:HINC

Image SHift Horizontal INCrement

Class ImageShift

Description Establishes the horizontal shifting increment value. The value must be less than or equal to the active horizontal resolution of the current video format, which can be queried with [HRES?](#). If an imageshift editing session is in progress (the [ISHB](#) command was issued), the value will be changed, but not applied to the hardware until the [ISHE](#) and [ISHU](#) commands are issued. Otherwise, the command will take effect immediately.

Command syntax `XISH:HINC increment`
increment
positive integer number

Query syntax `XISH:HINC?`

Query response Current horizontal shifting increment value.

Example 1 `XISH:HINC 4 //Sets the horizontal shifting increment to 4.`

Example 2 `XISH:HINC? //Queries for current horizontal shifting increment.`
`4`

Related commands [ISHA](#), [ISHB](#), [ISHE](#), [ISHG](#), [ISHK](#), [ISHL](#), [ISHN](#), [ISHP](#), [ISHQ?](#), [ISHS](#), [ISHU](#), [XISH:PATH](#), [XISH:SRCN](#), [XISH:TINC](#), [XISH:TTYP](#), [XISH:VINC](#)

XISH:PATH

Image Shift Path

Class ImageShift

Description Establishes two points along which the image will be shifted. The points are defined by two sets of x,y coordinates. The default coordinates are 0,0 and 100,100. The x coordinates must be less than or equal to the active horizontal resolution of the current video format, which can be queried with [HRES?](#). The y coordinates must be less than or equal to the active vertical resolution of the current video format, which can be queried with [VRES?](#). If an imageshift editing session is in progress (the [ISHB](#) command was issued), the path will be changed, but not applied to the hardware until the [ISHE](#) and [ISHU](#) commands are issued. Otherwise, the command will take effect immediately.

Command syntax `XISH:PATH x_start,y_start x_end,y_end`
`x_start,y_start x_end,y_end`
positive integer numbers

Query syntax `XISH:PATH?`

Query response `x_start,y_start x_end,y_end`

Example 1 `XISH:PATH 0,0 150,20 //Sets the start point to 0,0 and the end point to //150,20`

Example 2 `XISH:PATH? //Queries for current path.
0,0 150,20`

Related commands [ISHA](#), [ISHB](#), [ISHE](#), [ISHG](#), [ISHK](#), [ISHL](#), [ISHN](#), [ISHP](#), [ISHQ?](#), [ISHS](#), [ISHU](#), [XISH:HINC](#), [XISH:SRCN](#), [XISH:TINC](#), [XISH:TTYP](#), [XISH:VINC](#)

XISH:SRCN

Image SHift SouRCe Name

Class	Image Shift
Description	Establishes the image file or bitmap file that will be used for image shifting. The default file is /Cache0/Images/Ramp. If an imageshift editing session is in progress (the ISHB command was issued), the image source will be changed, but not applied to the hardware until the ISHE and ISHU commands are issued. Otherwise, the command will take effect immediately.
Command syntax	<p>XISH:SRCN <i>path/filename</i></p> <p><i>path/filename</i></p> <p>The directory path and valid MS-DOS filename (8 characters minus any extension) of the image or bitmap file to be used for image shifting. If the file to be used is in the default path, then <i>path/</i> may be omitted.</p>
Query syntax	XISH:SRCN?
Query response	<i>path/filename</i>
Example	<pre>XISH:SRCN Master //Selects the Master image as the current image to //shift</pre>
Related commands	ISHA , ISHB , ISHE , ISHG , ISHK , ISHL , ISHN , ISHP , ISHQ? , ISHS , ISHU , XISH:HINC , XISH:PATH , XISH:TINC , XISH:TTYP , XISH:VINC

XISH:TINC

Image Shift Time INCrement

Class Image Shift

Description Establishes the time shift increment value, which is the number of frames to pause before shifting the image. If an imageshift editing session is in progress (the [ISHB](#) command was issued), the value will be changed, but not applied to the hardware until the [ISHE](#) and [ISHU](#) commands are issued. Otherwise, the command will take effect immediately.

Command syntax XISH:TINC *increment*
increment
positive integer number 0 – 999

Query syntax XISH:TINC?

Query response Current time shift increment value.

Example 1 XISH:TINC 2 //Sets the time shift increment to 2.

Example 2 XISH:TINC? //Queries for current time shift increment.
2

Related commands [ISHA](#), [ISHB](#), [ISHE](#), [ISHG](#), [ISHK](#), [ISHL](#), [ISHN](#), [ISHP](#), [ISHQ?](#), [ISHS](#), [ISHU](#), [XISH:HINC](#), [XISH:PATH](#), [XISH:SRCN](#), [XISH:TTYP](#), [XISH:VINC](#)

XISH:TTYP

Image SHift Trace TYPE

Class Image Shift

Description Establishes the way in which image shifting will occur. A repeating trace type causes the image to shift between the start and end points, and then restart at the start point. A reverse trace type causes the image to shift between the start and end points, and then from the end point to the start point. If an imageshift editing session is in progress (the [ISHB](#) command was issued), the trace type will be changed, but not applied to the hardware until the [ISHE](#) and [ISHU](#) commands are issued. Otherwise, the command will take effect immediately.

Command syntax XISH:TTYP *type*
type
1 = Repeat
2 = Reverse

Query syntax XISH:TTYP?

Query response 1 or 2

Example 1 XISH:TTYP 1 //Sets the trace type to 1, Repeat.

Example 2 XISH:TTYP? //Queries for current trace type.
1

Related commands [ISHA](#), [ISHB](#), [ISHE](#), [ISHG](#), [ISHK](#), [ISHL](#), [ISHN](#), [ISHP](#), [ISHQ?](#), [ISHS](#), [ISHU](#), [XISH:HINC](#), [XISH:PATH](#), [XISH:SRCN](#), [XISH:TINC](#), [XISH:VINC](#)

XISH:VINC

Image SHift Vertical INCrement

Class Image Shift

Description Establishes the vertical shifting increment value. The value must be less than or equal to the active vertical resolution of the current video format, which can be queried with [VRES?](#). If an imageshift editing session is in progress (the [ISHB](#) command was issued), the value will be changed, but not applied to the hardware until the [ISHE](#) and [ISHU](#) commands are issued. Otherwise, the command will take effect immediately.

Command syntax `XISH:VINC increment`
increment
positive integer number

Query syntax `XISH:VINC?`

Query response Current vertical shifting increment value.

Example 1 `XISH:VINC 4 //Sets the vertical shifting increment to 4.`

Example 2 `XISH:HINC? //Queries for current vertical shifting increment.`
4

Related commands [ISHA](#), [ISHB](#), [ISHE](#), [ISHG](#), [ISHK](#), [ISHL](#), [ISHN](#), [ISHP](#), [ISHQ?](#), [ISHS](#), [ISHU](#), [XISH:HINC](#), [XISH:PATH](#), [XISH:SRCN](#), [XISH:TINC](#), [XISH:TTYP](#)

XLBW

Arbitrary Left Border Width

Class Format parameter setting - active video

Description Establishes the last horizontal pixel of a vertical pillar-box bar area at the left side of the image.

Command syntax *XLBW pixel_number*
pixel_number
0 to 65535 (in decimal)

Related commands [XBBH](#), [XRBW](#), [XTBH](#)

Example *XLBW 64*
FMTU

XMPG

MPEG InfoFrame Data

Class [InfoFrame Packet](#)

Description Writes MPEG InfoFrame packet data.

Command syntax (individual parameter) XMPG: *mpgparameter value*

Command syntax (complete packet) XMPG *type version length [MB [MF [FR]]]*

type
5

version
1

length (bytes)
10

The remaining are MPEG Infoframe data parameters (*mpgparameter*) as specified in EIA/CEA-861-B standard, Section 6.4:

VERS (same as *Version*)
Infoframe version

MB
MPEG bit rate (Enter rate in Hertz [Hz])

MF
MPEG frame (see EIA/CEA-861-B standard, Table 26 for settings)

FR
Field repeat (see EIA/CEA-861-B standard, Table 26 for settings)

Query syntax XMPG:*mpgparameter?*

Query response *value*

Example The following example sets the data rate of the MPEG transmission in the MPEG InfoFrame data to 44.1kHz.

```
XMPG:MB 44100
```

```
IFGU
```

Related commands [IFTR](#), [IFTG](#), [IFGU](#)

XRBW

Arbitrary Right Border Width

Class Format parameter setting - active video

Description Establishes the first horizontal pixel of a vertical pillar-bar area at the right side of the image.

Command syntax *XRBW pixel_number*
pixel_number
 0 to 65535 (in decimal)

Related commands [XISH:TTYP](#), [XTBH](#), [XBBH](#)

Example *XRBW 961*
FMTU

XRES

X axis RESolution for custom images

Class Image editor control

Description Sets the width factor used to scale horizontal size and position parameters in the primitives of a custom image in the image editor buffer. The XRES? query returns the current XRES setting.

Command syntax XRES *width*
width integer
16 to 65,536

Query syntax XRES?

Query response *width*

Example XRES 1600 // Set horizontal scaling factor to 1600
YRES 900 // Set vertical scaling factor to 900

XSPD

Source Product Description InfoFrame Data

Class [InfoFrame Packet](#)

Description Writes Source Product Description InfoFrame packet data.

Command syntax (individual parameter) XSPD: *spdparameter value*

Command syntax (complete packet) XSPD *type version length [VNS [PDS [SDI]]]*

type

3

version

1

length (bytes)

25

The remaining are Source Product Description Infoframe data parameters (*spdparameter*) as specified in EIA/CEA-861-B standard, Section 6.2:

VERS (same as *Version*)

Infoframe version

VNS

Vendor name string

PDS

Product description string

SDI

Source device information (see EIA/CEA-861-B standard, Table 17 for settings)

Query syntax XSPD:*spdparameter?*

Query response *value*

Example The following example sets the vendor name string (*VNS* parameter) to "QDI" in the Source Product Description Infoframe.

IFGU

XSPD:VNS QDI

Example 2 The following example specifies a Source Product Description InfoFrame with these properties:

- Vendor name is QDI
- Product description is HDMI-Analyzer
- Source device is Digital STB (1)

```
XSPD 3 1 25 QDI HDMI-Analyzer 1
```

Example 3 The following example reports the current setting for the Product Description parameter in the Source Product Description Infoframe.

```
XSPD:PDS?
```

XTBH

Arbitrary Top Border Height

Class [Parameters \(Video Signal\)](#)

Description Establishes the last line of a horizontal letterbox bar area at the top of the image.

Command syntax *XTBW line_number*
line_number
0 to 65535

Related commands [XISH:TTYP](#), [XRBW](#), [XBBH](#)

Example *XTBH 15*
FMTU

XVSG

Video Signal Gating

Class Format parameter settings

Description Determines which video outputs are active when the format is selected. The same command controls both the analog and digital video outputs.

Command syntax *XVSG red_mode, green_mode, blue_mode*
red_mode, green_mode, blue_mode
0 = OFF
1 = ON

Other required commands The [FMTU](#) command instructs the generator to use the new setting. The [ALLU](#) command updates hardware to the new setting and redraws the test image.

Example

```
XVSG 1 1 1 // Enable all color channels
FMTU // Update hardware to current buffer contents
```

XVSI

Video Signal Interface

Class	Format video signal
Description	Enables the specified video signal interface output for the analyzer.
Command syntax	<i>XVSI interface</i> or <i>XVSI:OUT interface</i> <i>interface</i> 1 = DVI-A (analog) 2 = DVI-D (digital) 3 = HDMI-D (DVI) 4 = HDMI-H (HDMI) 5 = SVIDEO 6 = CVBS 7 = SDI, HD-SDI 9 = VGA 10 = DisplayPort
Query syntax	<i>XVSI?</i> or <i>XVSI:OUT?</i>
Query response	<i>interface</i>
Other required commands	The ALLU command updates hardware to the new setting and redraws the test image.
Example 1	<pre>XVSI 1 // Enable DVI for analog output ALLU // Update hardware to current buffer contents XVSI 3 // Enable HDMI interface for DVI output ALLU // Update hardware to current buffer contents XVSI:OUT 4 // Enable HDMI interface for HDMI output ALLU // Update hardware to current buffer contents</pre>

Example 2 `XVSI?` //Queries for the currently-enabled video signal interface output
4 //HDMI-H output is currently enabled

Related commands [XVSI:IN](#)

YRES

Y axis RESolution for custom images

Class	Image editor control
Description	Sets the height factor used to scale vertical size and position parameters in the primitives of a custom image in the image editor buffer. The YRES? query returns the current YRES setting.
Command syntax	<i>YRES height</i> <i>height integer</i> 16 to 65,536
Query syntax	YRES?
Query response	<i>height</i>
Example	<pre>XRES 1600 // Set horizontal scaling factor to 1600 YRES 900 // Set vertical scaling factor to 900</pre>
Example	<pre>dirn mydir // create a directory named mymap dirb // begin directory context nami 1 smpte133 // insert the name smpte133 at index 1 nami 2 flat // insert the name flat at index 2 nami 3 raster // insert the name raster at index 3 dire // end directory context dirs // save map named mymap dirl mydir // load directory mydir into edit buffer dirb // begin directory context namq? 1 10 // list mydir names namy 2 // yank name at index 2 nami 1 colorbar // insert new name at index 1 dire // end directory context dira newdir // save modified mydir as newdir dirq? 1 10 // list available directories // (up to 10 maps starting with the 1st)</pre>

B Image Reference

Topics in this appendix:

- [Standard image descriptions](#)

Standard image descriptions

3DCRTK

Description Test image for testing 3D crosstalk.

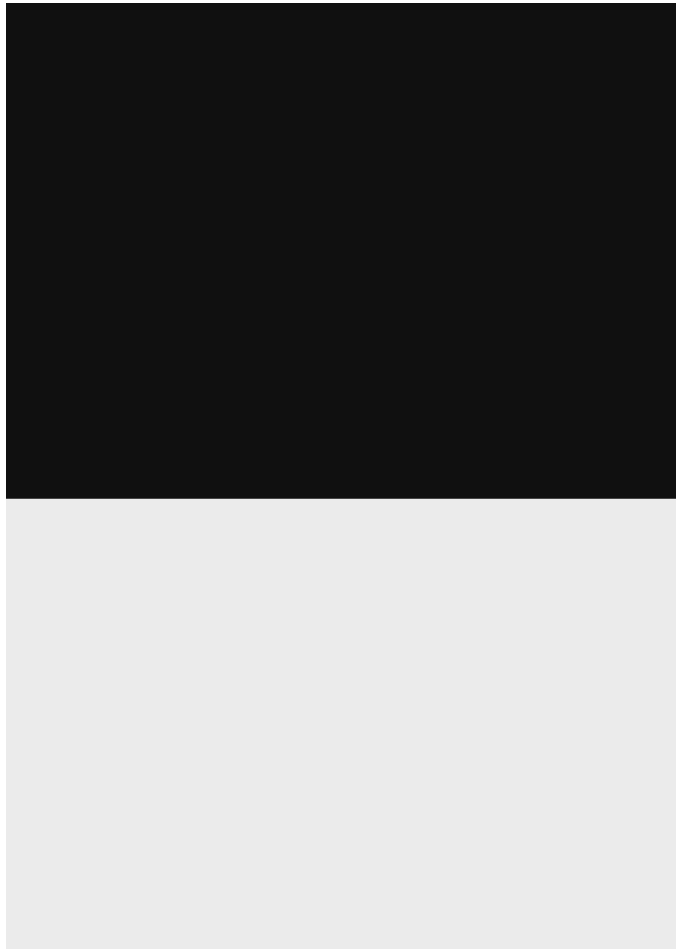

3DCUBES

Description Test image for testing 3D motion.

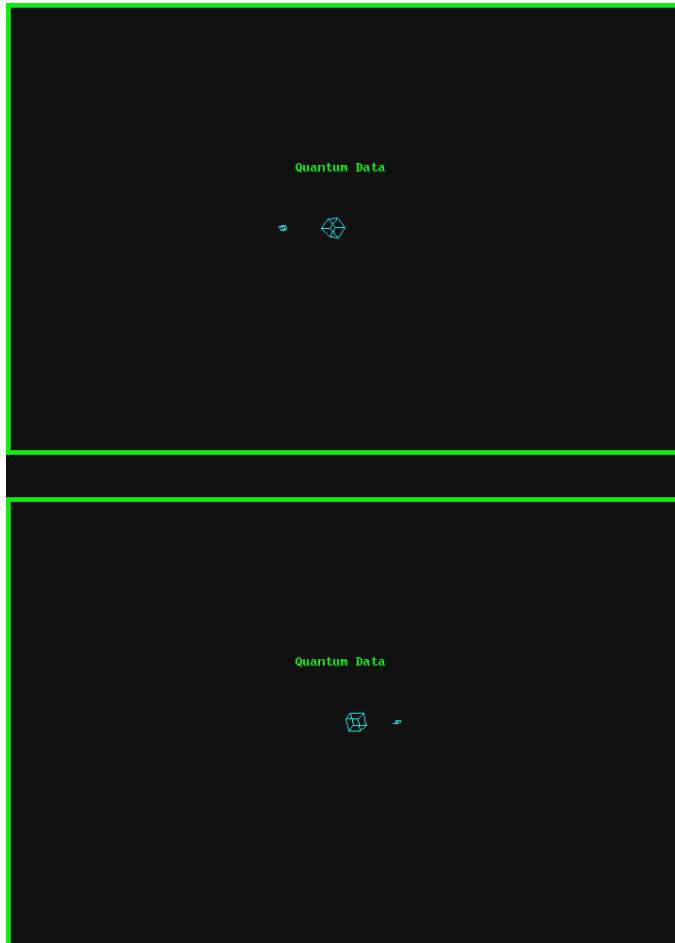

Acer1

Description Special test image developed per customer specifications. Consists of two sets of color bars and five blocks of “#” characters on a white crosshatch with a black background.

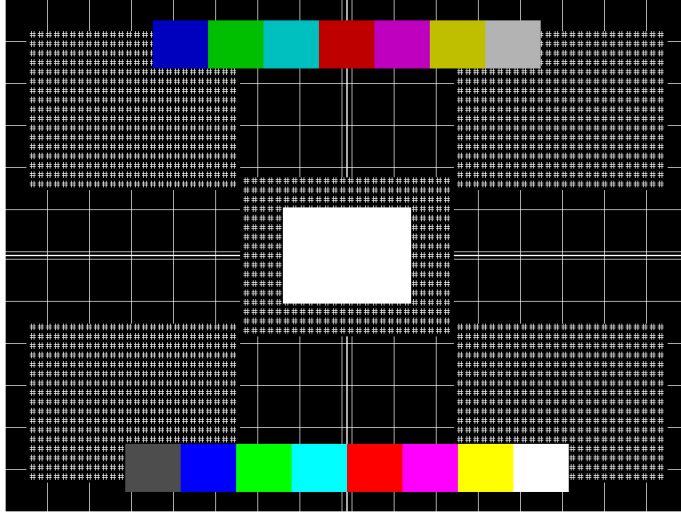

Acer2

Description Special test image developed per customer specifications. Consists of colorbars, lines of “#” characters, and a green border.

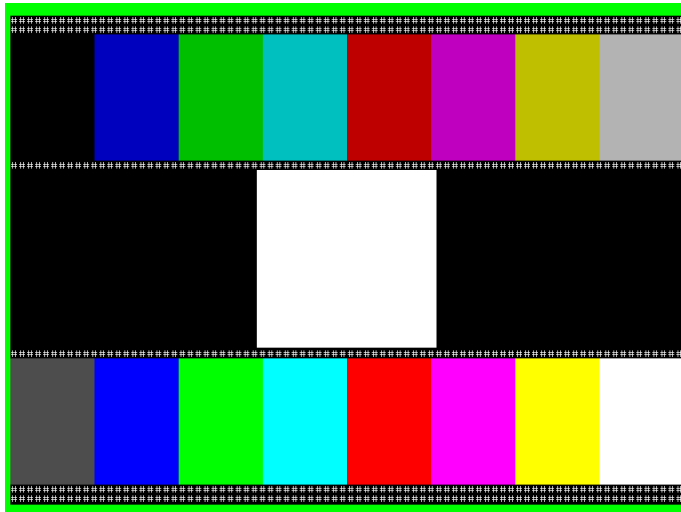

Acer3, Acer4, Acer5 and Acer6

Description Special test images developed per customer specifications. Consists of large and small white circles centered on either a yellow (Acer3), magenta (Acer4), cyan (Acer5), or white (Acer6) crosshatch on a black background. The Acer3 image is shown below.

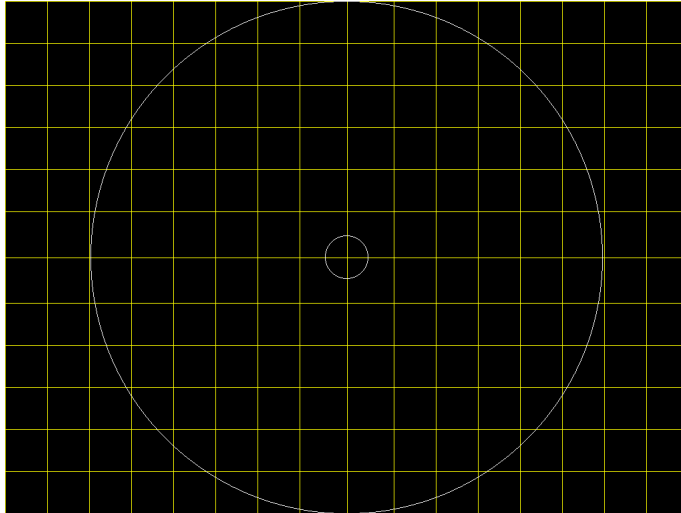

Acer7 and Acer8

Description Special test image developed per customer specifications. In the primary version, five blocks of either white “#” (Acer7) or “H” (Acer8) characters on a black background are displayed. A secondary version displays black characters on a white background. The Acer7 image is shown below.

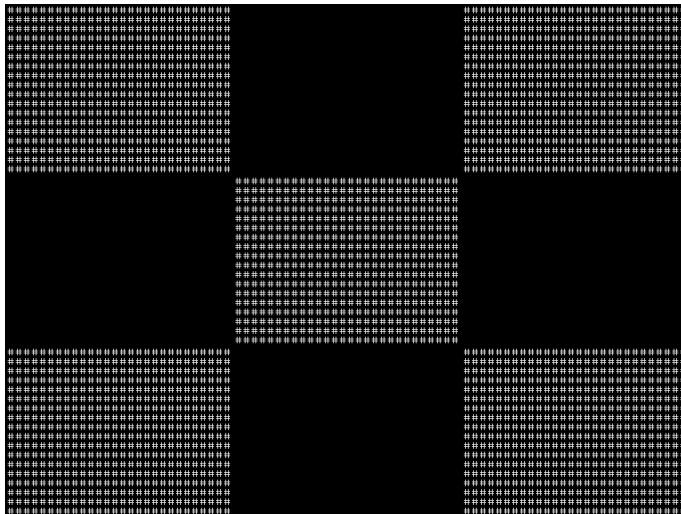

Acer9

Description Special test image developed per customer specifications. In the primary version, a mostly white field is displayed with two rows of color bars at the bottom. A secondary version displays a black field with the two rows of color bars at the bottom.

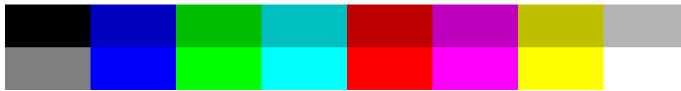

AFDtest

Description Used to test HDMI content mapping using different EIA/CEA-861-B formats. There are 10 different versions of this image. For more information, see [“Testing with Active Format Description \(AFD\) \(882 only\)”](#) on page 306.

AnsiGray

Description The primary version displays a white background with a small black pixel in the center fills the active video area. A secondary version displays a black background with a small white pixel in the center.

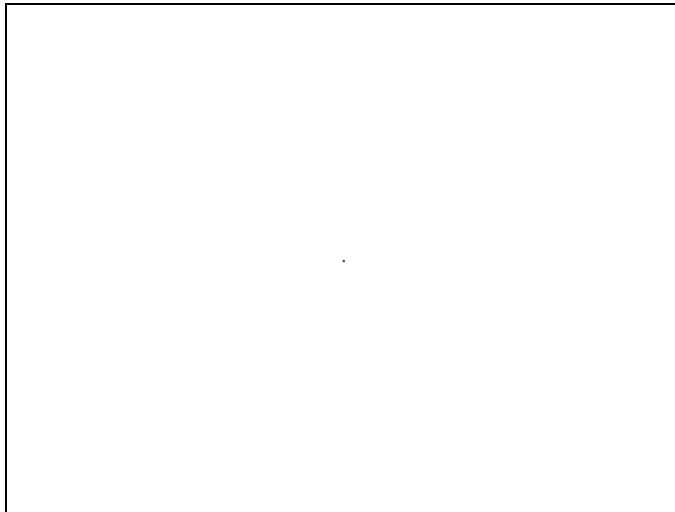

AnsiLght

Description The primary version displays a white background with a small black pixel in the center fills the active video area. A secondary version displays a black background with a small white pixel in the center.

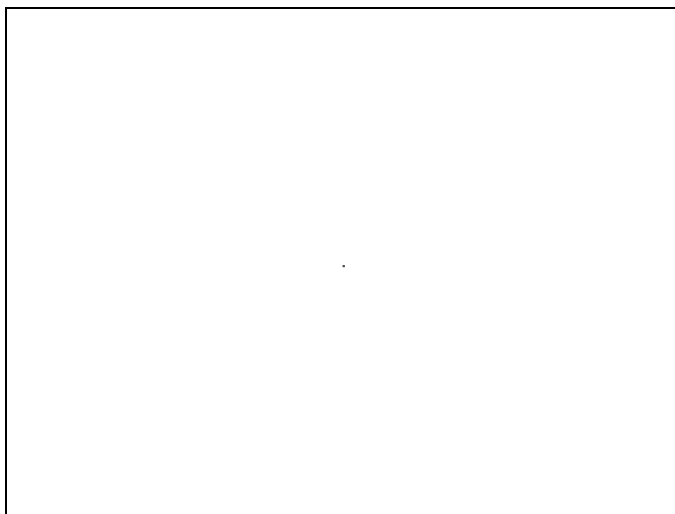

Apple1

Description Special test image developed per customer specifications. A secondary version shows reverse (black characters on white background).

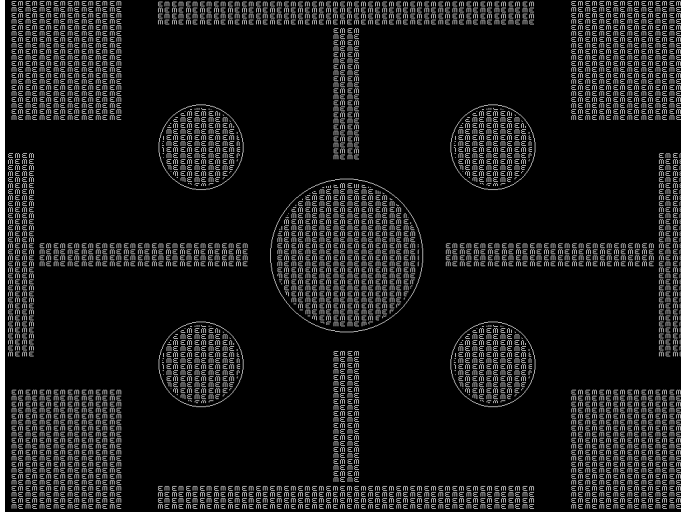

Audio LR, AudioLRf, AudioRAT, Audio_L, Audio_Lf, Audio_R, Audio_Rf

Description Used to configure HDMI audio output signal. The AudioLR is shown below. For more information, see [“Testing HDMI audio”](#) on page 289.

BarBlack

Description Special test image developed per customer specifications.

A secondary version shows reverse (black lines on white background).

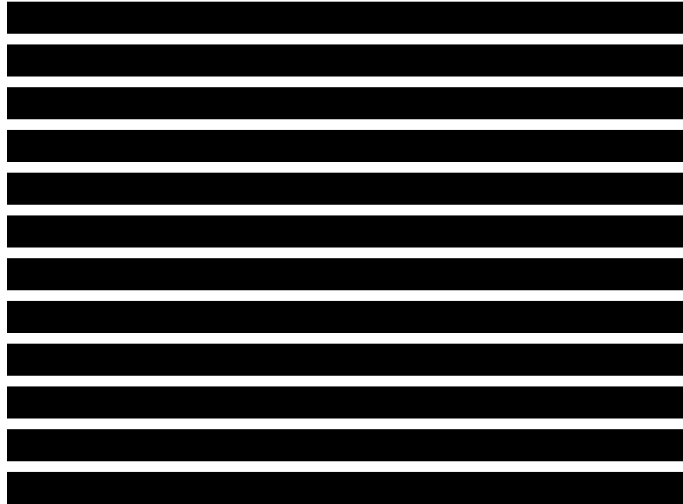

BLU_EM, GRN_EM, RED_EM, WHT_EM, MEME1111, MEMESony, MESony_B, MESony_G, and MESony_R

Description In the primary version, the screen is filled with blue (BLU and B), green (GRN and G), red (R), or white (WHT, MEME1111, MEMEPlus, and MEMESony) EM character blocks on a black background. Only the white character has a secondary version. It is drawn with black characters on a white background.

A bitmap of a single character block is shown here. The BLU_EM image is shown below.

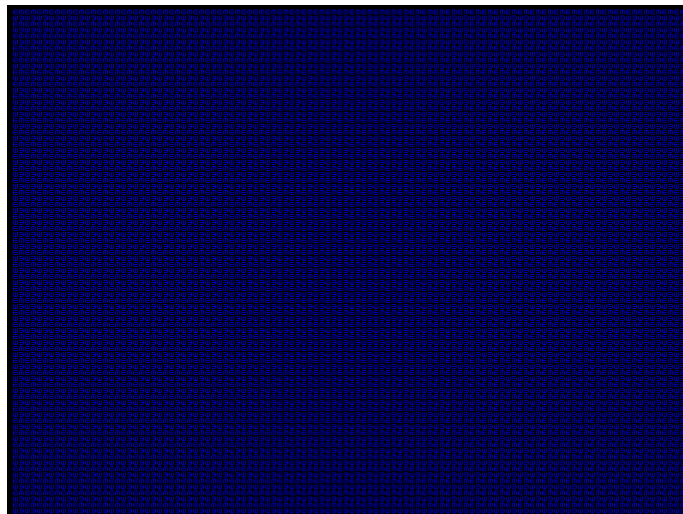

Test Focus

Purpose This pattern is specified by some display manufacturers for checking and adjusting focus one color at a time.

BLU_EM+, GRN_EM+, RED_EM+, WHT_EM+, MEMEPlus, MEPlus_B, MEPlus_G, and MEPlus_R

Description In the primary version, the screen is filled with blue (BLU and B), green (GRN and G), red (R), or white (WHT and Sony) EM character blocks on a black background. Only the white character has a secondary version. It is drawn with black characters on a white background.

A bitmap of a single character block is shown here. The BLU_EM+ image is shown below.

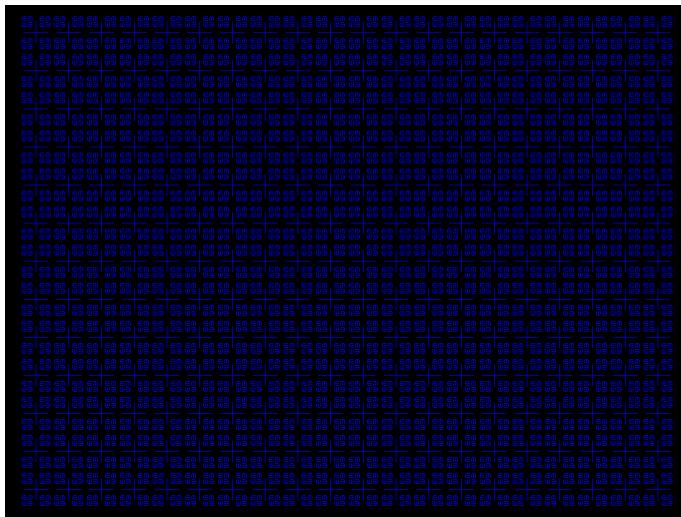

Test Focus

Purpose This pattern is specified by one or more display manufacturers for checking and adjusting focus one color at a time.

BLU_PIC, GRAY_PIC, GRN_PIC, RED_PIC, WHT_PIC

Description A solid blue (BLU), gray, green (GRN), red, or white (WHT) box fills the active video area. Only the white fill has a secondary version. It can be changed to a black fill by pressing the **Step** key. The BLU_PIC image is shown below.

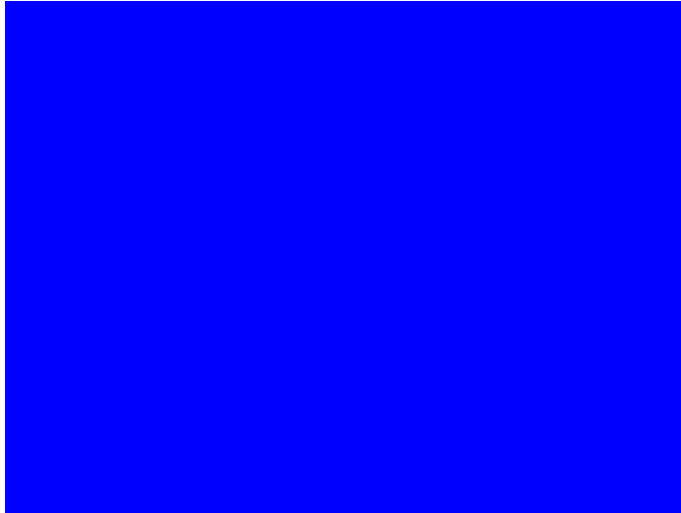

Test Purity adjustment

Purpose To produce correct colors in a displayed image, the electron beams from each of the three (3) guns in the CRT should strike only their matching phosphors. A white image shows patches of various colors on a monitor with bad purity. The purity adjustment(s) should be performed before doing any brightness or color tests. In some cases, purity adjustments involve loosening and repositioning the yoke, in which case purity should be adjusted prior to doing any geometry tests.

Method The methods used for adjusting purity on a color monitor depend on the type of monitor and CRT (for example; Delta, In-Line or Single Gun). In most cases, the first step is to degauss the CRT.

Note: For a Delta Gun CRT, turn on only the red output. A solid uniform field of red should appear. If the color is not uniform, adjust the yoke and the Purity Tabs assembly.

If purity cannot be corrected to acceptable limits, the monitor may not have been properly degaussed or there may be a defect in the CRT or purity assembly.

Test Shadow mask warping

Purpose The purity characteristics of your CRT can change over time if you leave it on with a lot of video being displayed. This may be due to the CRT's electron beams striking its shadow mask with enough energy to cause the mask to heat. This internal heating may be enough to cause the shadow mask to warp and give bad purity.

Method Set the purity image to white and allow the monitor to run for a few minutes. Any mask warping shows up as a change in purity. You can use a color meter to measure the change. The BriteBox pattern may also be useful for measuring shadow mask warping.

Bosch

Description Special test image developed per customer specifications. This image has 6 versions.

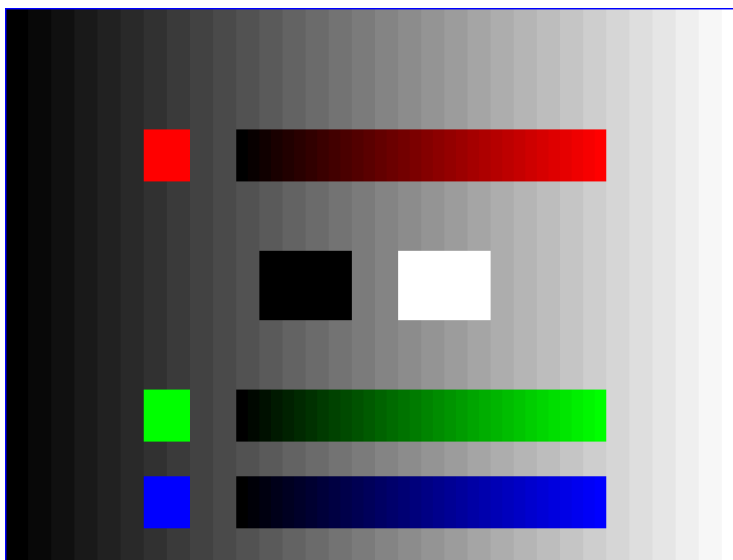

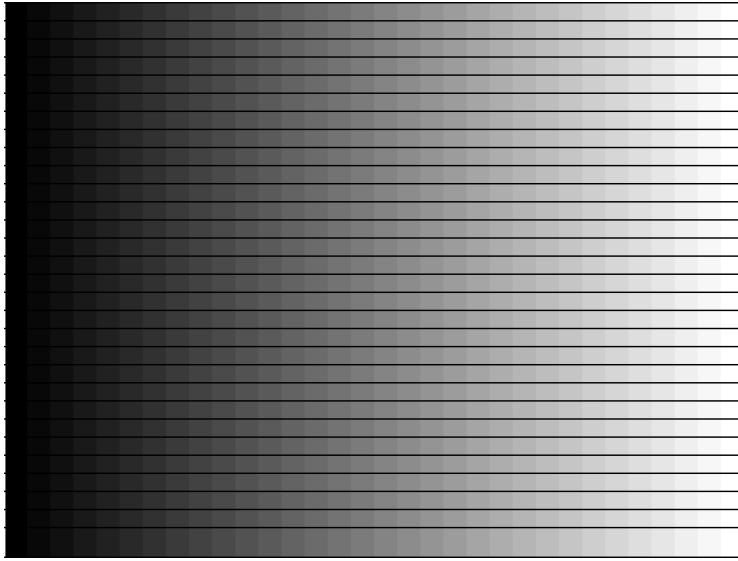

Box_50mm, Box_64mm, Box100mm, Box150mm, Box200mm, Box250mm

Description The primary version has a solid white box in the center of the active video. Depending on the image selected, the box is sized by square millimeters. If there is room, information on the current format appears below and to the left of the box. This shows the number of active pixels and lines as well as the horizontal and vertical scan rates. A forward slash (/) after the number of active lines indicates the format is interlaced.

Note: The box will be the correct size only if the correct physical active video size is set in the format.

The Box_50mm image is shown below. The secondary version draws a black box and black text on a white background.

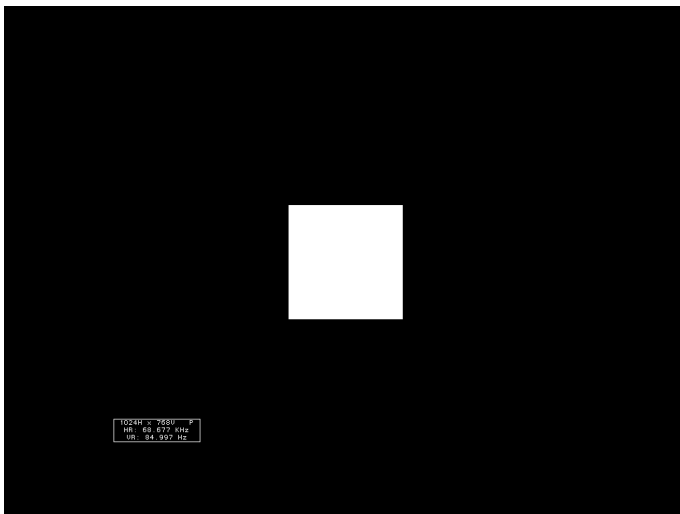

Test Brightness control adjustment

Purpose The wrong brightness setting may cause other tests such as Contrast, Focus, and Beam Size to be invalid. An accurate brightness setting helps give repeatable measurements throughout other tests.

Method Center your light meter probe within the center square and adjust the monitor's brightness control to obtain the required light meter reading.

BriteBox

Description The primary version has a single white box in the center of active video. The box size is controlled by the MSIZ system parameter. The secondary version adds four boxes in the corners of active video.

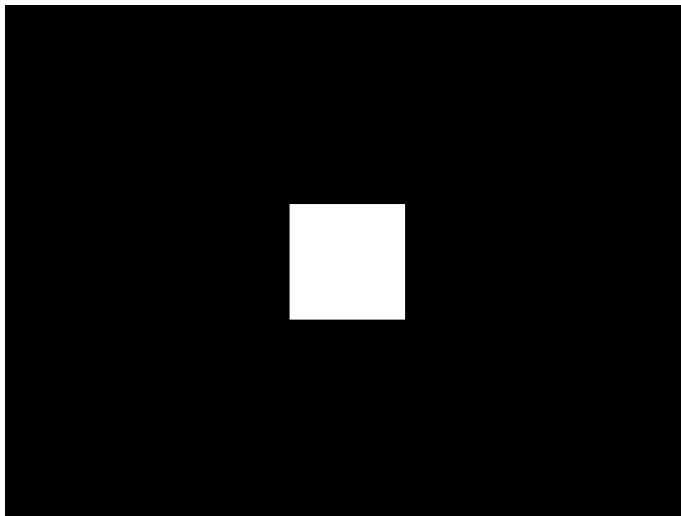

Test Brightness control adjustment

Purpose The wrong brightness setting may cause other tests such as Contrast, Focus, and Beam Size to be invalid. An accurate brightness setting helps give repeatable measurements throughout other tests.

Method Center your light meter probe within the center square and adjust the monitor's brightness control to obtain the required light meter reading.

Test Brightness uniformity

Purpose The light output of most picture tubes varies slightly when measured across the CRT face. This test can be used to verify that the light output variation is within your specification limits.

Method Select the inverted version and perform the Brightness Control Adjustment test on the center box. Then, center the light meter probe in each of the corner squares and note the reading you get for each square. The deviation between each of the corner readings and the center reading should be within your specification limits.

Burst (TV formats only)

Description The left side starts with reference white (+100 IRE) and black (+7.5 IRE) levels. This is followed by six bursts of sine waves. Each burst is at a different frequency, forming vertical lines of various widths. The frequencies, going from left to right, are 0.5, 1, 2, 3, 3.58, and 4.43 MHz.

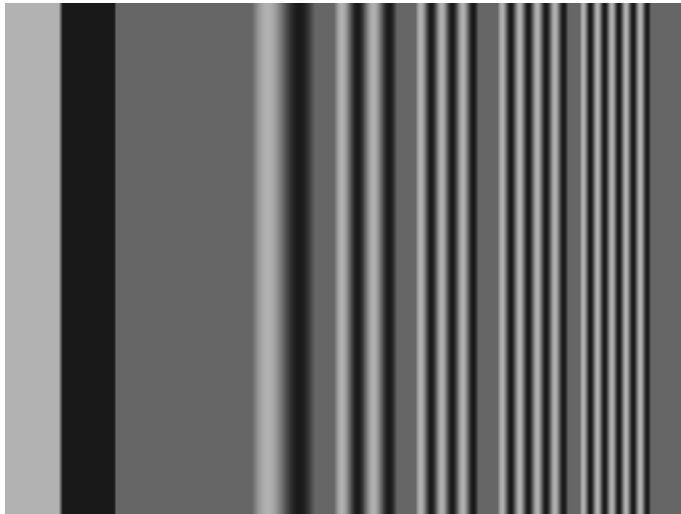

Test Frequency response

Method When viewed on a TV screen, the peak intensities of all of the bursts should match the white reference level. The darkest portions between the peaks should match the black reference level.

The image can also be used with a TV waveform analyzer to check the frequency response of a video system. One scan line of the image, as it would appear on a waveform analyzer, is shown at the top of the next page. High frequency roll-off (loss) would show up as a decrease in the peak-to-peak swings on the right side of the waveform. Low frequency roll-off would show up as a decrease in the peak-to-peak swings on the left side of the waveform.

Some waveform analyzers can be set to detect and display the amplitude of the peaks. A typical amplitude waveform for a good system is shown at the bottom of the next page.

BurstTCE

Description Fills screen with a 0.5 MHz frequency. This can be increased in 0.5 MHz increments by pressing the Contents key and then the Options key. You then enable More and use the +/- increment keys.

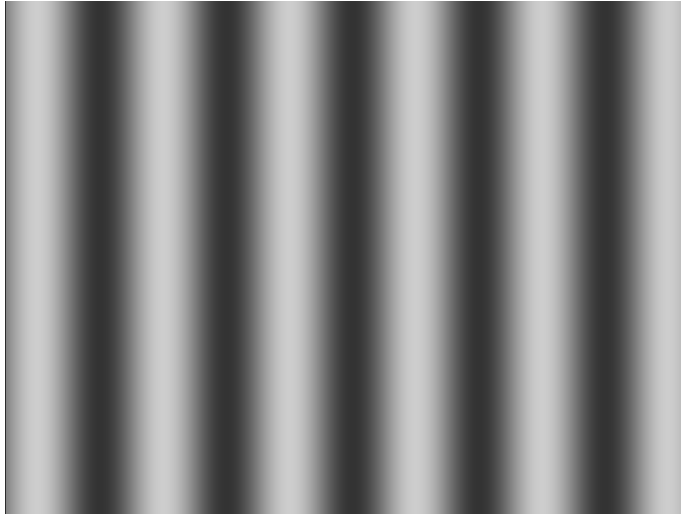

Check511

Description Consists of five small boxes in the corners and at the center of the active video. The boxes are on a black background. Each box consists of alternating black and white pixels that form a very fine checkerboard. The secondary version inverts the image, creating a white background. The colors of the individual pixels in the boxes also are inverted.

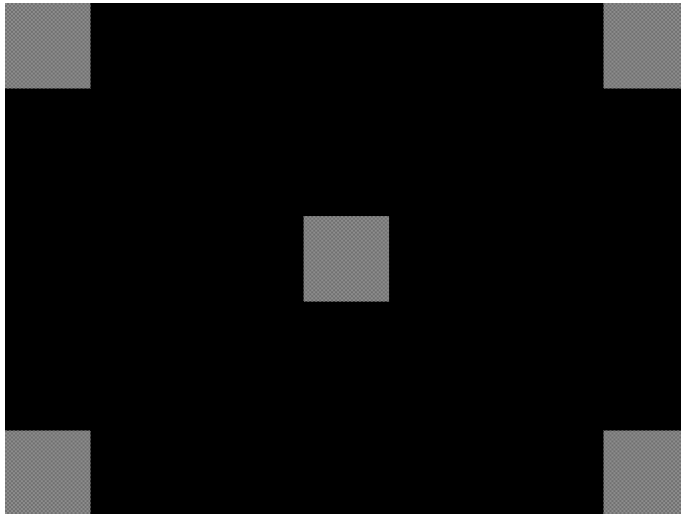

Test Verify monitor resolution

Purpose The resolution of your monitor should meet or exceed the design specifications.

Method First adjust the brightness, contrast, and focus to their correct settings. You should be able to see individual and distinct pixels in each of the boxes. Failure to see distinct pixels may indicate you have a defective video amplifier, focus correction circuit, or picture tube.

Note: *If multi-colored areas appear on a mask-type color picture tube, you may have a problem with convergence or you may be exceeding the resolution of the picture tube.*

CheckBy3

Description The active video area is equally divided into a 3x3 checkerboard of black and white boxes. The primary version has four white boxes as shown in the image below. The secondary version has five white boxes (reverse).

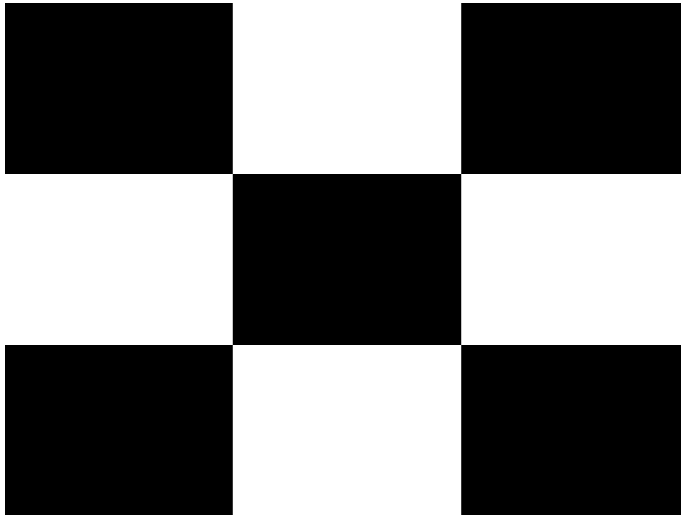

Test Contrast ratio

Purpose The pattern is based on a proposed ANSI method of measuring the contrast ratio of video projection systems.

Method Using a light meter probe, measure and record the light-level reading (in foot lamberts) in the center of each of the black and white boxes. The contrast ratio is expressed as the average of all of the white readings divided by the average of all of the black readings.

Check_02

Description Primary version is shown below. The secondary version has reverse (black lines on white background).

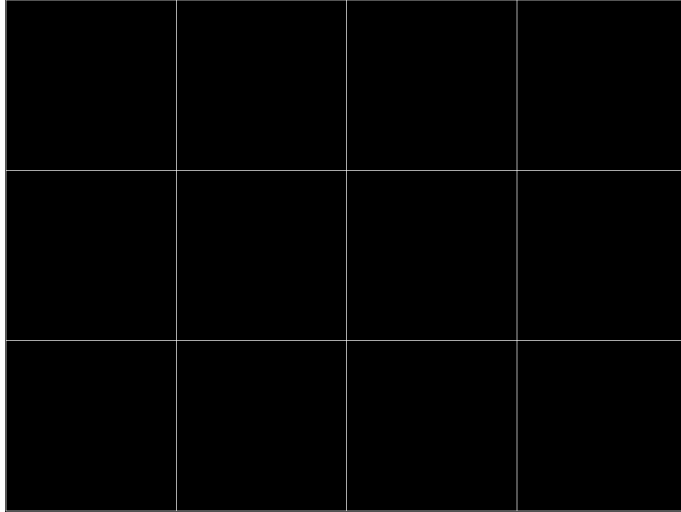

Check_11

Description In the primary version, the active video area is filled with alternating black and white pixels that form a very fine checkerboard, as shown below. The secondary version inverts the colors in the image. The inverted image looks almost the same as the non-inverted version.



Test Verify monitor resolution

Purpose The resolution of your monitor should meet or exceed the design specifications.

Method Adjust the brightness, contrast, and focus to their correct settings first. You should be able to see individual and distinct pixels in each of the boxes. Failure to see distinct pixels may indicate you have a defective video amplifier, focus correction circuit, or picture tube.

Note: *If multi-colored areas appear on a mask-type color picture tube, you may have a problem with convergence, or you may be exceeding the resolution of the picture tube.*

CirclesL

Description Special test image developed per customer specifications. In the primary version (shown below), the image consists of five large white circles on a black background. The circles are positioned in the center and in the corners of the active video area. The secondary version inverts the image to black circles on a white background.

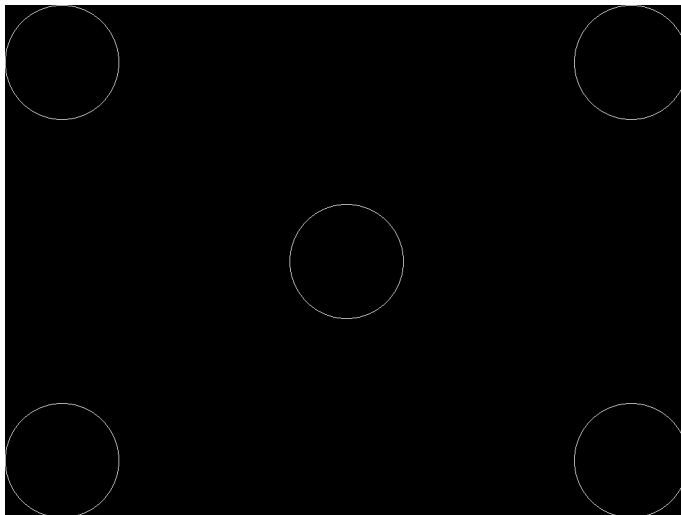

Purpose This pattern is specified by some monitor manufacturers for checking and adjusting video scan size, linearity, and over scanning.

CirclesS

Description Special test image developed per customer specifications. In the primary version (shown below), the image consists of eight small white circles on a black background. The circles are positioned in the corners of the active video area and centered on each edge of the active video area. The secondary version inverts the image to black circles on a white background.

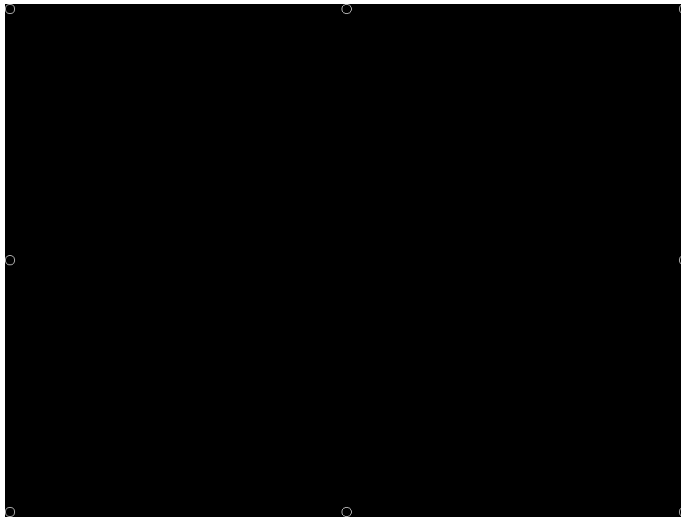

Purpose This pattern is specified by some monitor manufacturers for checking and adjusting video scan size, linearity, and over scanning.

ColorBar

Description The primary version (shown below) has 16 full-height vertical color bars. The secondary version splits the field into a top and bottom half. The bars in the bottom half of the screen are in reverse order.

Note: When outputting digital video, 33% Gray changes to 50% Gray, and 67% Gray becomes either Black or some gray level depending on how the display interprets the video information.

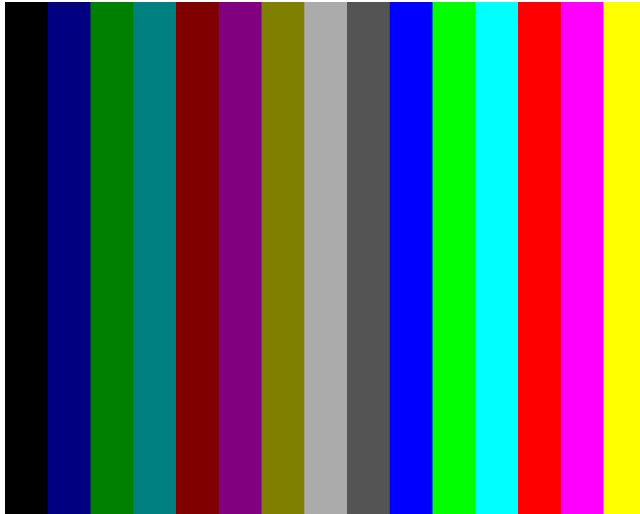

Test Verify that all video channels are functional

Purpose To verify that none of the video channels are bad or connected incorrectly.

Method Compare the sequence of color bars with the table. Missing bars may indicate a dead or unconnected channel. The transition between the bars should be sharp and distinct. Each bar should also be uniform in color and intensity across its entire width. Non-uniformity may indicate problems with the response of the video amplifiers. If all the bars are present but in the wrong order, one or more inputs may be swapped.

ComFocus

Description Special test image developed per customer specifications.

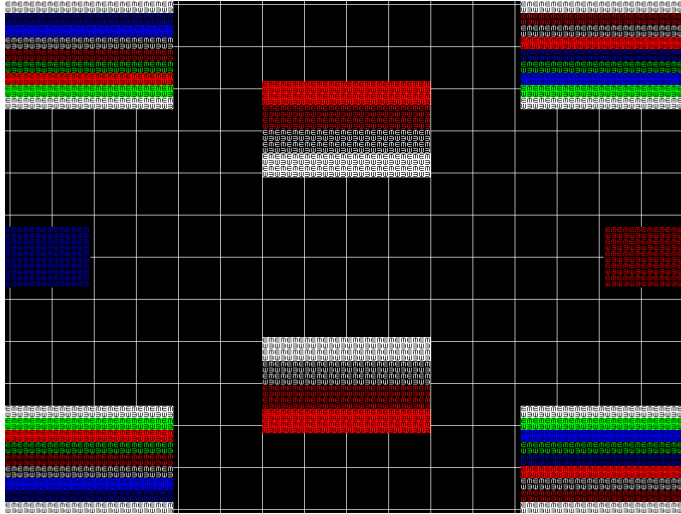

Cubes

Description This is an animated image consisting of one small multicolored cube orbiting around a larger multicolored cube. Each cube also is spinning on its own axis. The default text string is *Quantum Data*, which can be changed using commands. The primary version (shown below) has a black background and a thick green border. The secondary version uses a white background.

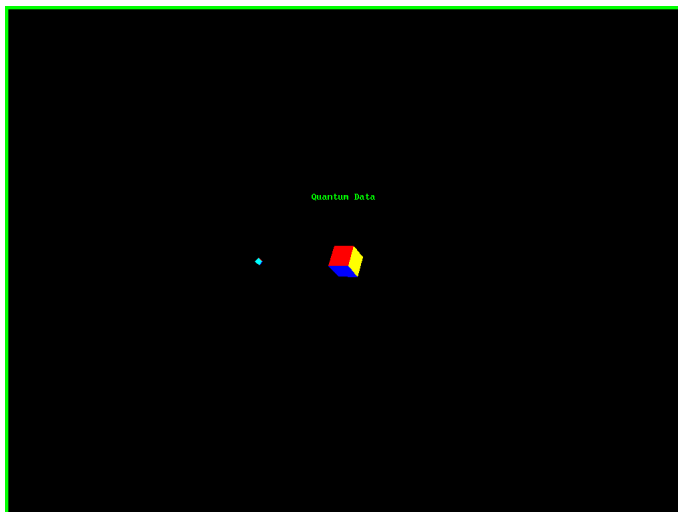

Purpose Can be used for show demonstrations with your own text.

Diamond1

Description Special test image developed per customer specifications.

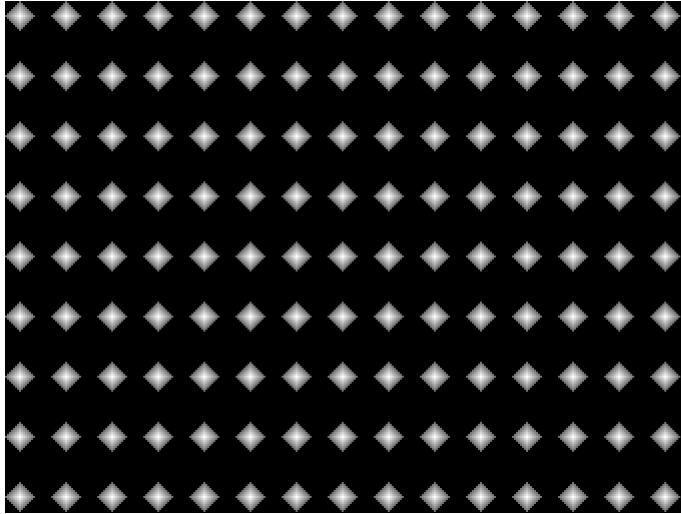

Dot1606, Dot1610, Dot1612, Dot1615, Dot1812, Dot1815, Dot2016

Description The primary version has white pixel dots on a black background. The secondary version has black pixel dots on a white background.

The primary version of the Dot2016 image is shown below.

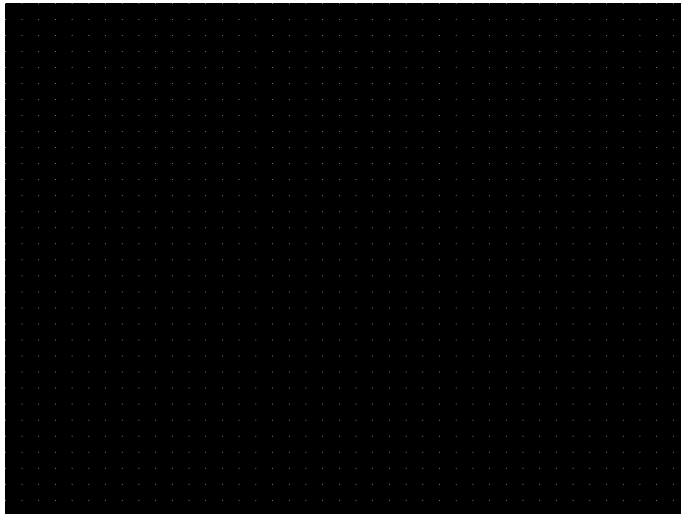

Dot_10, Dot_12, Dot_24

Description The active video area is filled with multiple rows of white, single pixel dots. The dots define the corners of what would appear to be square boxes if all connecting pixels were lit. The number of rows of boxes and the number of boxes per row depends on which version of the image is selected and the screen aspect ratio of the currently-loaded format. The number in the image's name refers to the number of boxes that will be formed along the minor axis for most aspect ratios. The generator calculates the ratio and then finds the closest match from the following table.

Aspect Ratio		Dot_10		Dot_12		Dot_24	
W : H	Decimal	Number of Rows	Boxes per Row	Number of Rows	Boxes per Row	Number of Rows	Boxes per Row
16 : 9	1.777 É	10	16	10	16	18	32
5 : 3	1.666 É	10	16	10	16	18	30
4 : 3	1.333 É	10	14	12	16	24	32
1 : 1	1.000	10	10	12	12	24	24
3 : 4	0.750	14	10	16	12	32	24

The primary version has white pixel dots on a black background. A secondary version has black pixel dots on a white background.

The primary version of the Dot_24 image is shown below.

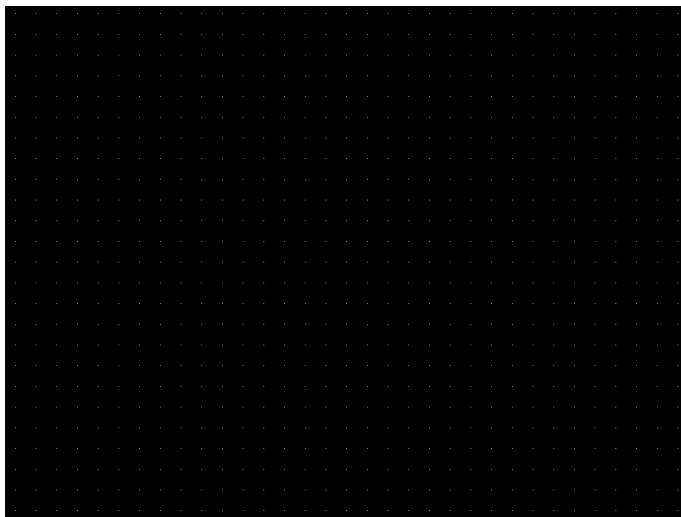

Purpose To accurately produce an image on a color monitor, the three electron beams in the CRT must meet (converge) at the same location at the same time. Small dots displayed on a misconverged monitor appear as a group of multi-colored dots.

- Method** The convergence adjustments of most color monitors fall into two main categories. The first set of adjustments, usually called Static Convergence, aligns the three beams in the center of the display. This method involves turning on all three guns and adjusting the various magnets on the convergence assembly to produce all white dots in the center of the display. The convergence assembly is located on the neck of the CRT. Different monitors and CRT types may each require their own magnet-adjustment sequence.
- After the center of the display is properly converged, the outer areas are adjusted by using the monitor's Dynamic Convergence controls. The number of controls, the area of the screen they affect, and their adjustment procedure depends on the monitor under test.
- Test** Focus adjustments
- Purpose** An out-of-focus monitor displays fuzzy pixels which, in turn, result in poorly formed and hard-to-read characters.
- Method** On monitors with a single (static) focus adjustment, adjust the control for the best average focus over the entire screen. The focus at certain locations should be within specified limits.
- Some monitors have a static and one or more dynamic focus controls. The sequence for adjusting them and the areas of the screen they affect depend on the monitor under test.

DV_Swing

- Description** This image is only available with DVI and HDMI. The DV_Swing image is used to temporarily change the digital video swing (DVSS format parameter) between 90 and 1620 mVp-p of the HDMI and DVI digital output for the active format. This image displays the current video swing value over a graduated (ramp) background. This image is supported by HDMI boards (revision F or later), and DVI boards with FPGA F1 or later.

Note: The DVSC command can be used to set the swing value between 150 and 1500 mVp-p.

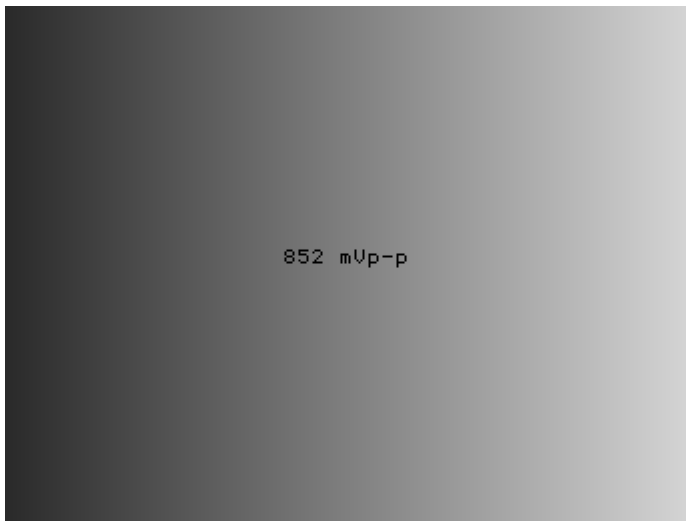

Method To adjust the swing in 6 mV increments, press the Contents key and then the Options key. You then enable More and use the +/- increment keys to proceed through the subimages.

Dyna

Description This image has multiple versions that display different sizes of the same pattern. Version 0 is shown below.

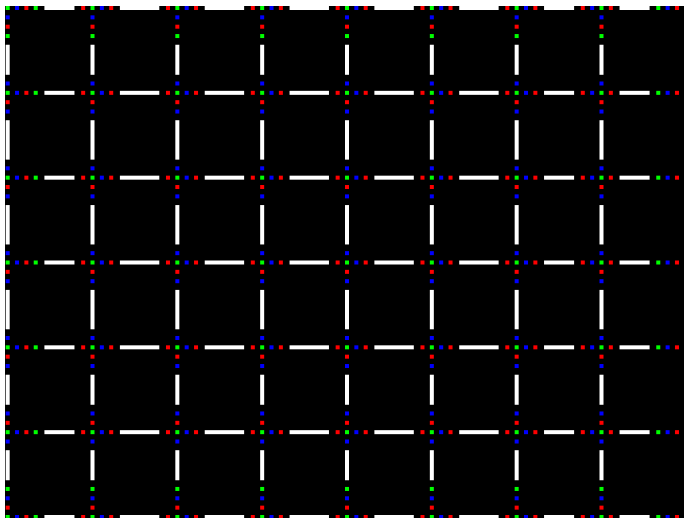

EdidData

Description Displays EDID from the display connected with the generator. For more information, see page 327.

Elbit

Description Special test image developed per customer specifications. This image has 19 versions.



EMITest1, EMITest2, EMITest3, EMITest4, EMITest5

Description Special test images used for electro-magnetic interference (EMI) testing of displays. The entire active video area is filled with an “H” character. The primary versions of these images draw white characters on a black background. The secondary versions draw black characters on a white background. The EMITest1 image is shown below.

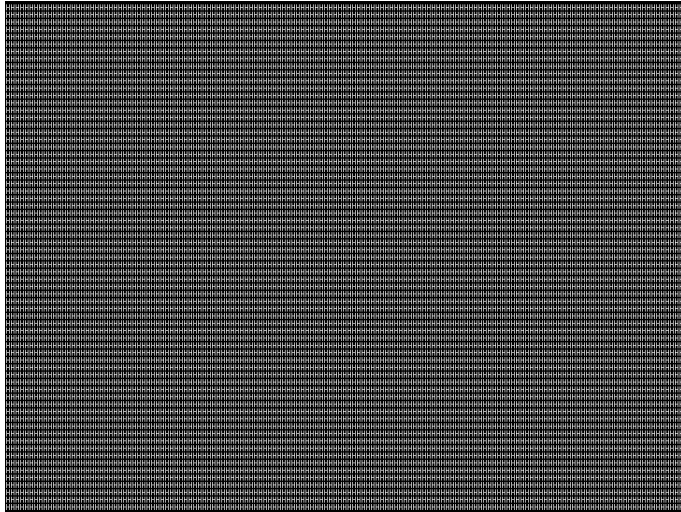

The EMITest2 image is the same as EMITest1, but with the bottom row of characters constantly drawn left-to-right and then cleared.

The EMITest3 image is the same as EMITest1, but with a larger version of the “H” character.



The EMITest4 image is the same as EMITest3, but with the bottom row of characters constantly drawn left-to-right and then cleared.

The EMITest5 image is shown below.

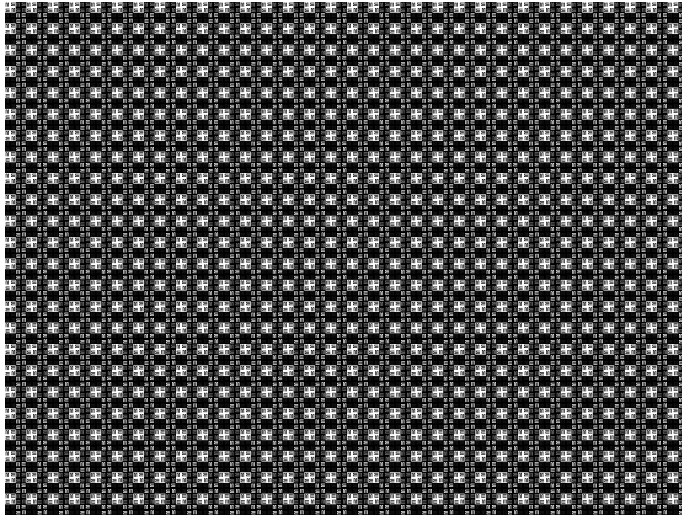

Flat, Flat07, Flat13, Flat20, Flat27, Flat33, Flat40, Flat47, Flat53, Flat60, Flat67, Flat73, Flat80, Flat87, Flat93, FlatGray, Flat_01, Flat_02, Flat_03, Flat_04, Flat_05, Flat_06, Flat_07, Flat_08, Flat_09, Flat_10, Flat_11, Flat_12, Flat_13, Flat_14, Flat_15, Flat_16

Description The entire active video area is filled with a shade of gray. Each image displays a different shade of gray. The FlatGray image is shown below.



Flat_B, Flat_G, Flat_R

Description The screen is filled with blue (B), green (G) or red (R). The Flat_B image is shown below.



Focus20

Description Primary version shown below. The secondary version has black characters on a white background.

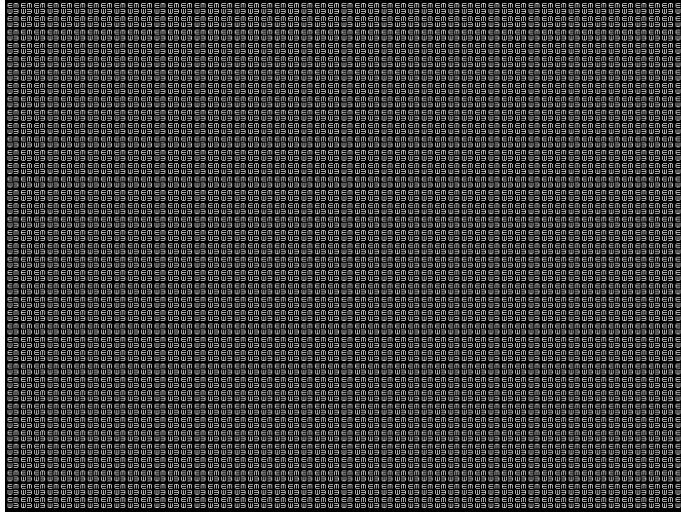

FocusC14

Description Primary version shown below. The secondary version has black characters on a white background.

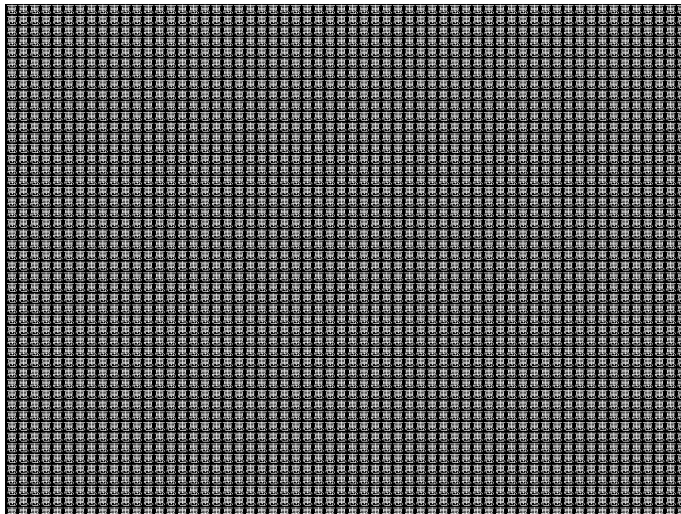

FocusCCx

Description Primary version shown below. The secondary version has black characters on a white background.

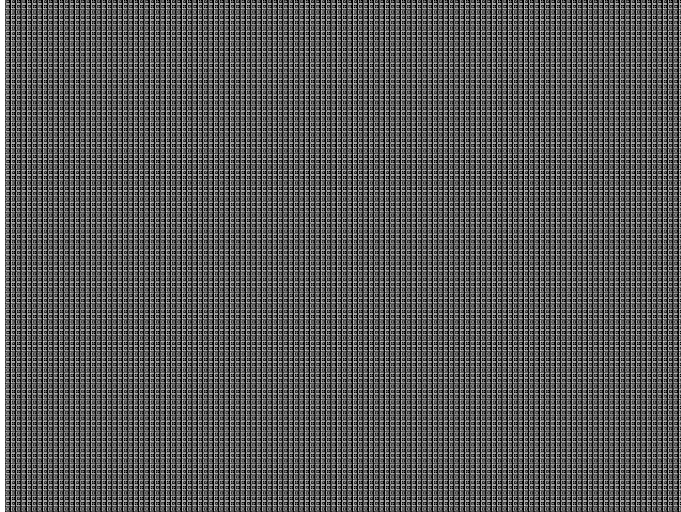

FocusEM

Description Primary version shown below. The secondary version has black characters on a white background.

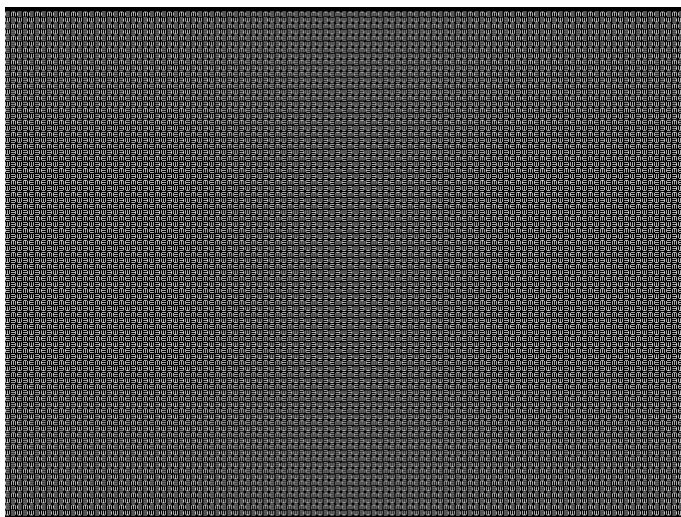

FocusEMP

Description Primary version shown below. The secondary version has black characters on a white background.

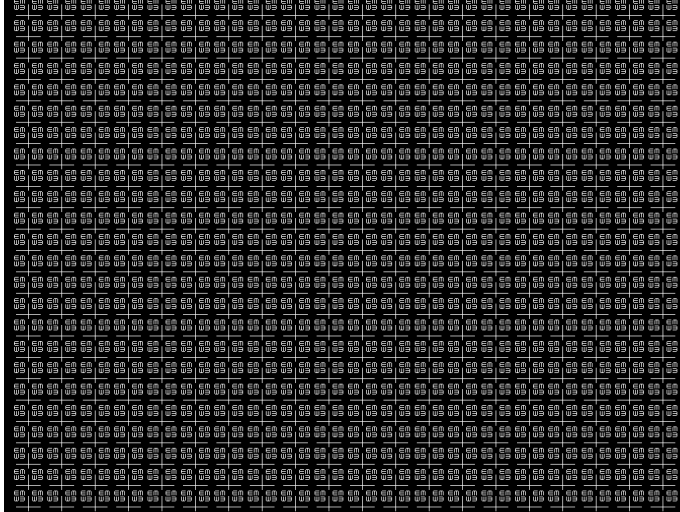

FocusM00 - FocusM15

Description The FocusM00 image is shown below.

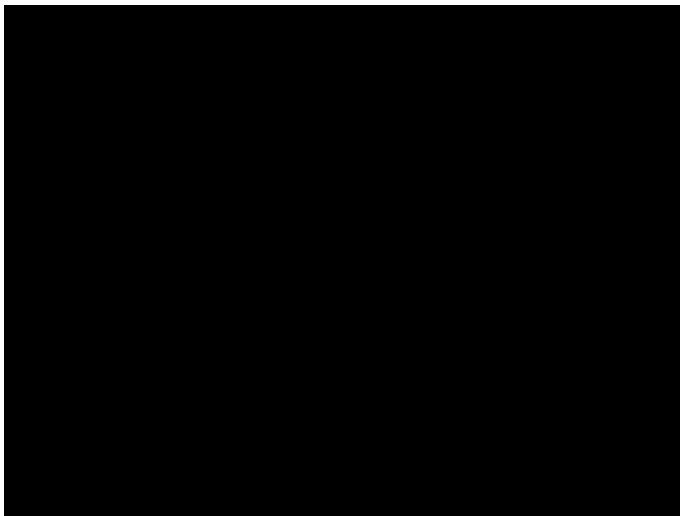

Focus_@6, Focus_@7, Focus_@8, Focus_@9

Description In the primary versions, the screen is filled with white “@” characters on a black background. The secondary versions are drawn with black characters on a white background. The primary version of the Focus_@6 image is shown below.

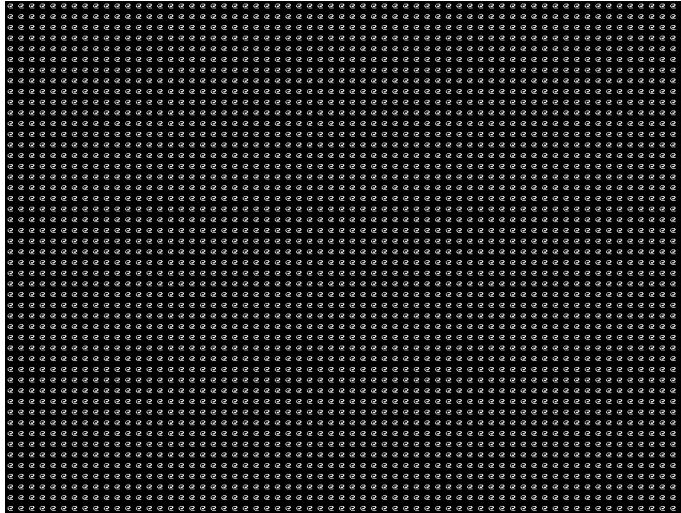

Test Focus adjustments

Purpose An out-of-focus monitor displays fuzzy graphic images and poorly formed, hard-to-read text characters.

Method On monitors with a single (static) focus adjustment, adjust the control for the best average focus over the entire screen. The focus at certain locations of the screen should be within specified limits.

Some monitors have a static and one or more dynamic focus controls. The sequence for adjusting them and the areas of the screen that they affect depend on the monitor under test.

Focus_Cx

Description In the primary version (shown below), the screen is filled with white Cx characters on a black background. The secondary version is drawn with black characters on a white background.



Test Focus adjustments

Purpose An out-of-focus monitor displays fuzzy graphic images and poorly formed, hard-to-read text characters.

Method On monitors with a single (static) focus adjustment, adjust the control for the best average focus over the entire screen. The focus at certain locations of the screen should be within specified limits.

Some monitors have a static and one or more dynamic focus controls. The sequence for adjusting them and the areas of the screen that they affect depend on the monitor under test.

Focus_H

Description In the primary version (shown below), the screen is filled with white H characters on a black background. The secondary version is drawn with black characters on a white background.

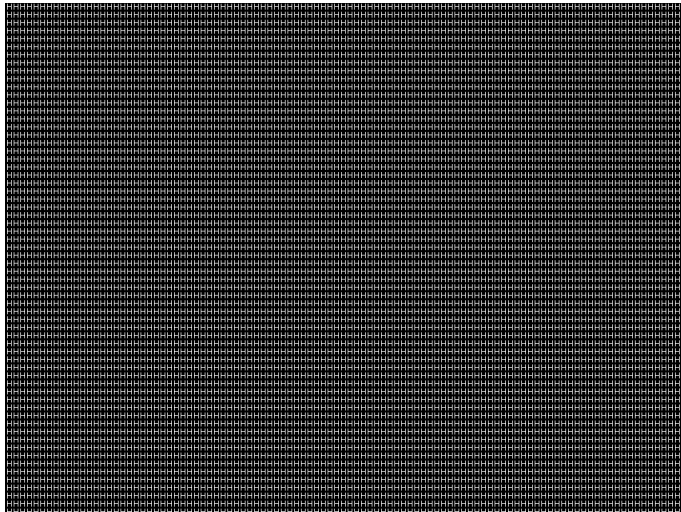

Test Focus adjustments)

Purpose An out-of-focus monitor displays fuzzy graphic images and poorly formed, hard-to-read text characters.

Method On monitors with a single (static) focus adjustment, adjust the control for the best average focus over the entire screen. The focus at certain locations of the screen should be within specified limits.

Some monitors have a static and one or more dynamic focus controls. The sequence for adjusting them and the areas of the screen that they affect depend on the monitor under test.

Focus_MM

Description In the primary version (shown below), the screen is filled with white M characters on a black background. The secondary version is drawn with black characters on a white background.

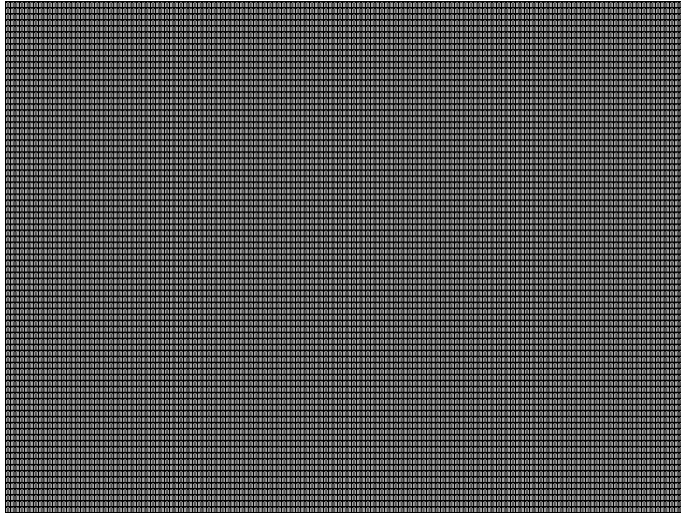

Focus_Oo

Description In the primary version (shown below), the screen is filled with white Oo characters on a black background. The secondary version is drawn with black characters on a white background.

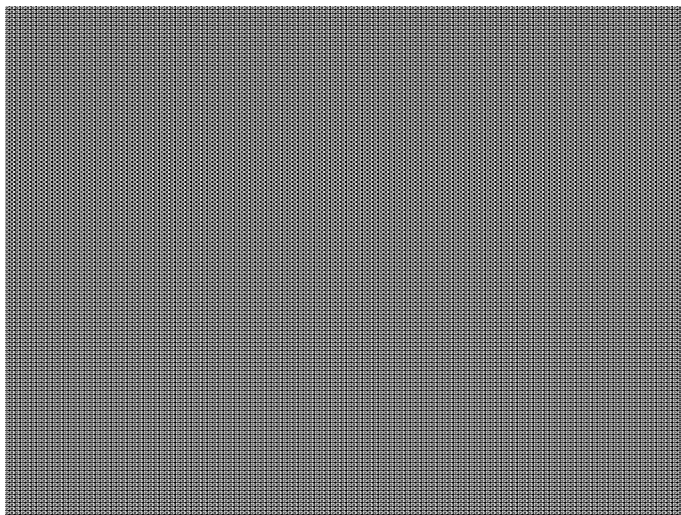

Test Focus adjustments

- Purpose** An out-of-focus monitor displays fuzzy graphic images and poorly formed, hard-to-read text characters.
- Method** On monitors with a single (static) focus adjustment, adjust the control for the best average focus over the entire screen. The focus at certain locations of the screen should be within specified limits.
- Some monitors have a static and one or more dynamic focus controls. The sequence for adjusting them and the areas of the screen that they affect depend on the monitor under test.

Format

- Description** A listing of the data contained in any format. The primary image lists the settings of the format driving the display. The secondary image can be used to list the contents of any stored format (via the Location field).

This pattern works best at display resolutions of at least 640 pixel by 480 lines.

```

Name: DM10660                               Pixel Rate:
Location: 151                               25.200 MHz    39.683 ns
Entry units: Machine
Rate: 31.500 KHz*                            Horizontal   Vertical
Active: 640 pixels* 25.397 us                480 lines*  15.238 ms
Blank: 160 pixels  6.349 us                  45 lines    1.429 ms
Period: 800 pixels* 31.746 us                525 lines*  16.657 ms
Physical size: 11.200 inches 284.480 mm      8.400 inches 213.360 mm
Pulse delay: 16 pixels 0.635 us              10 lines    0.317 ms
Pulse width: 96 pixels 3.810 us               2 lines     0.063 ms
EQ Before: 0 lines
EQ After: 0 lines
Scan: Progressive (non-interlace)
ACS kind: American DRed                      On: -G-
DCS kind: American DRed
DSS kind: American separate
Sync select: DSS
Video kind: Analog RGB (color)
Video bias: 0.000 volts blank minus ground
Video swing: 0.700 volts white minus blank
Sync swing: 0.300 volts blank minus sync
Gamma: OFF 2.200
Display code expected: E Code read: F

```

Geom_1 - Geom_5

Description The primary version of the Geom_1 image is shown below. Secondary version is drawn with black lines on a white background.

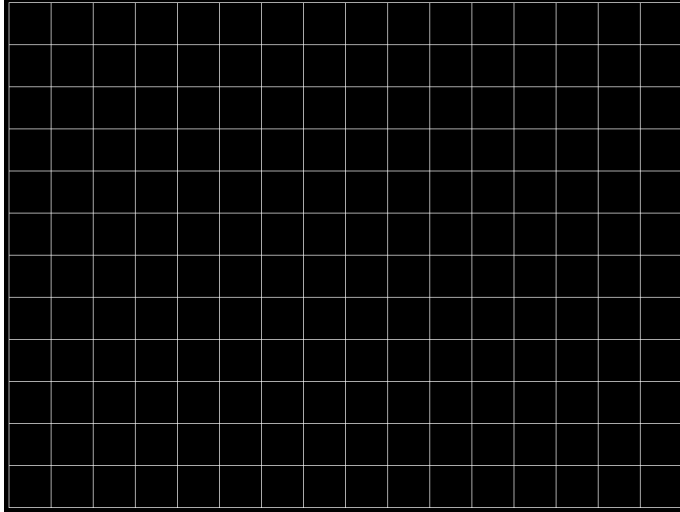

Gray25, Gray40

Description The Gray25 image is shown below.



GrayBar

Description The primary version (shown below) has 16 full-height vertical graybars. The intensity of the bars is shown below. The secondary version splits the field into a top and bottom half. The bars in the bottom half of the screen are in reverse order.

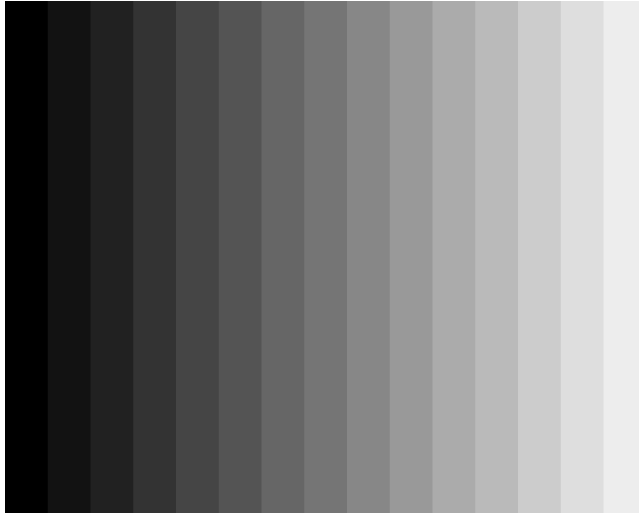

Test Video color tracking (color monitors)

Purpose To verify that a color monitor accurately reproduces colors at all intensities.

Method Perform the Brightness Control Adjustment and Brightness Uniformity tests first.
Changes in brightness from bar to bar should be uniform. All of the bars should appear as an untinted gray at all levels.

Test Video gain linearity (monochrome monitors)

Purpose To check the video linearity (grayscale modulation)

Method Perform the Brightness Control Adjustment and Brightness Uniformity tests first.
Changes in brightness from bar to bar should be visible and uniform.

GrayL1, GrayL3

Description The GrayL1 image is shown below.



Grays5, Grays9, Grays11, Grays16, Grays32, Grays64

Description These images have the designated number of full-height vertical graybars.
The Grays11 image is shown below.

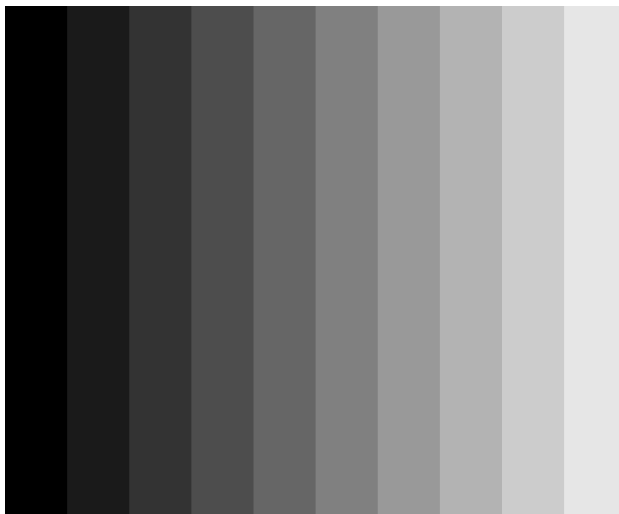

GraysAll

Description Contains 256 grayscale versions, from 0 (full black) to 255 (full white).

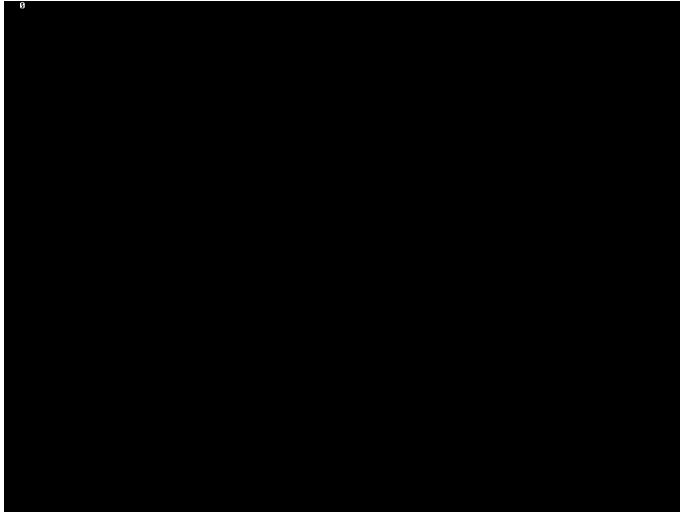

Grill_11, Grill_15, Grill_22, Grill_33, Grill_44

Description The entire active video area is filled with alternating black and white stripes. The stripes are drawn at different resolutions. Each of the stripes is four (4) pixels wide in the Grill_44 image and three (3) pixels wide in the Grill_33 image. Each of the stripes is two (2) pixels wide in the Grill_22 image and one (1) pixel wide in the Grill_11 image.

The primary versions draw vertical stripes. The secondary versions draw horizontal stripes. The primary version of the Grill_44 image is shown below.

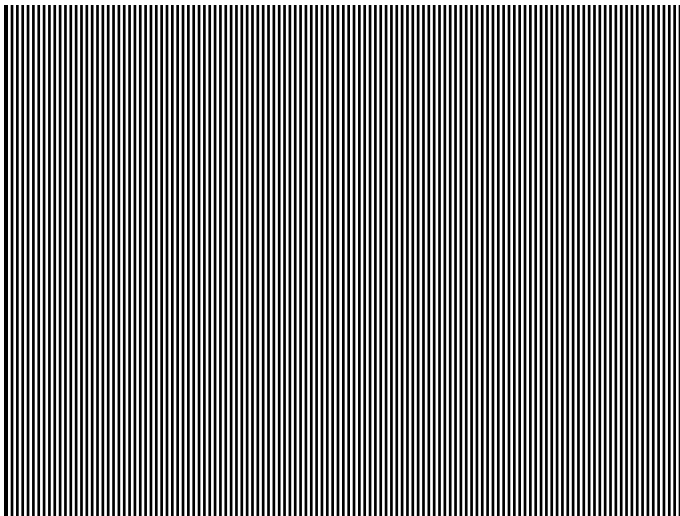

Test Verify monitor resolution

Purpose The resolution of your monitor should meet or exceed the design specifications.

Method First adjust the brightness, contrast, and focus to their correct settings. You should be able to see individual and distinct stripes in all areas of the display at all four resolutions. Failure to see distinct lines at the highest resolution (Grill_11) may indicate you have a defective video amplifier or picture tube.

Note: *If multi-colored lines appear on a mask-type color picture tube, you may have a problem with convergence or you may be exceeding the resolution of the picture tube.*

HalfArea

Description Primary version shown below. Secondary version is drawn with black boxes and white background.

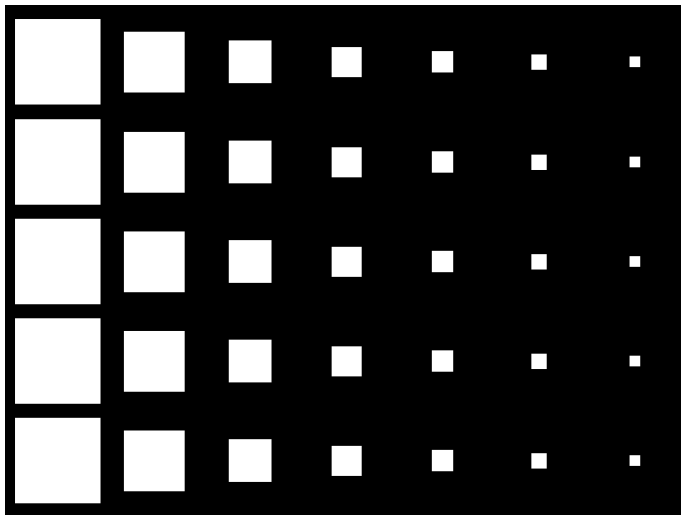

HalfCIk

Description

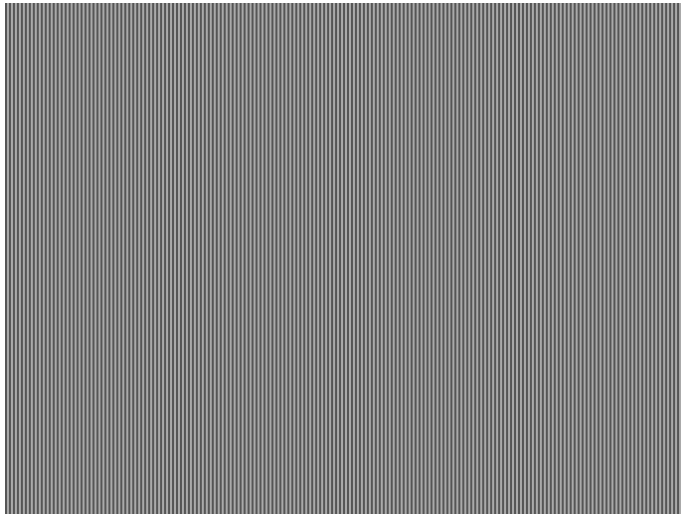

Hat1606, Hat1610, Hat1612, Hat1615

Description Primary version of Hat1606 is shown below. Secondary version is inverted.

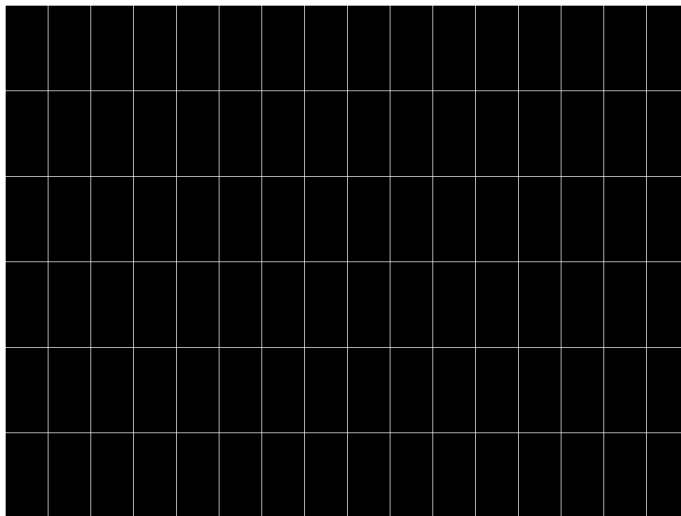

Hat1606A, Hat1610A, Hat1612A, Hat1615A

Description Primary version of Hat1606A is shown below. Secondary version is inversed.

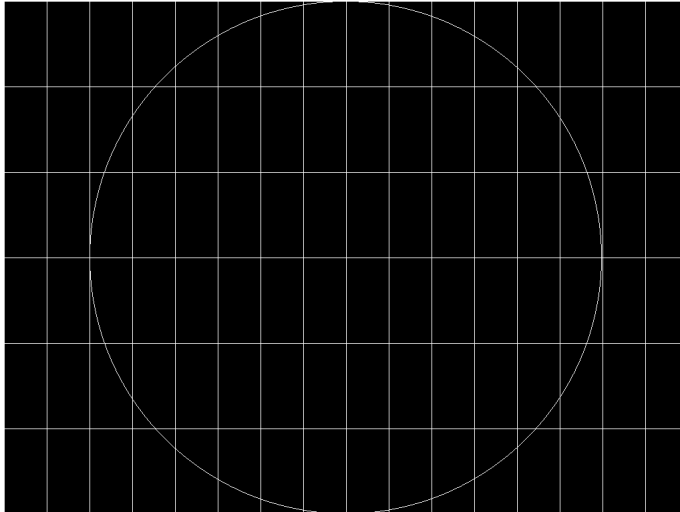

Hat1812, Hat1815

Description Primary version of Hat1812 is shown below. Secondary version is inversed.

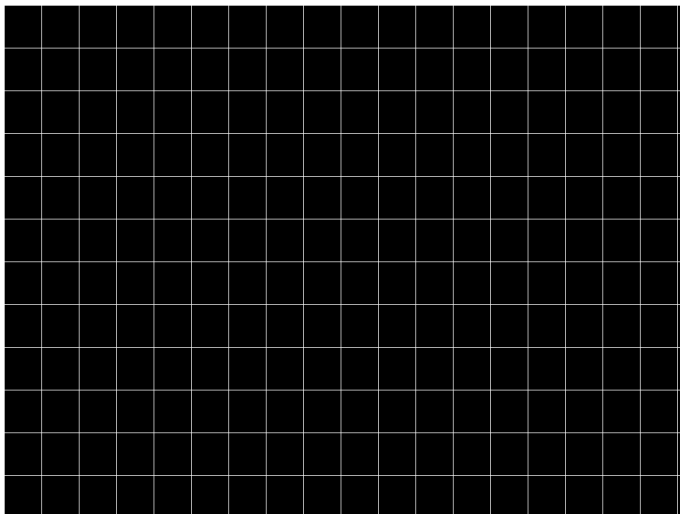

Hat1812A, Hat1815A

Description Primary version of Hat1812A is shown below. Secondary version is inverted.

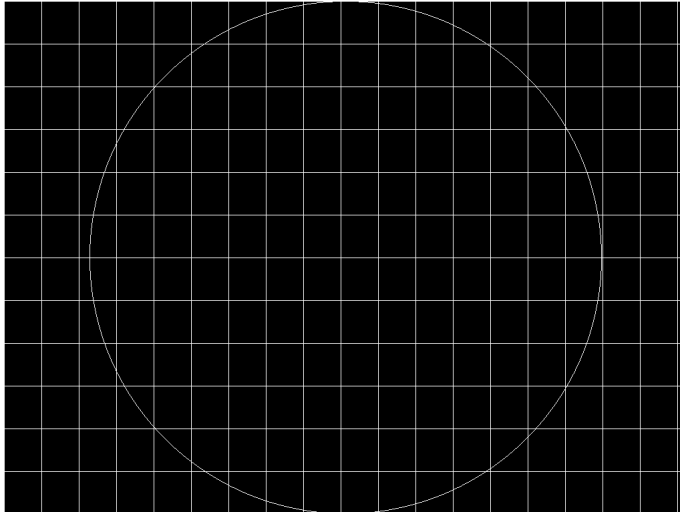

Hat2016

Description Primary version is shown below. Secondary version is inverted.

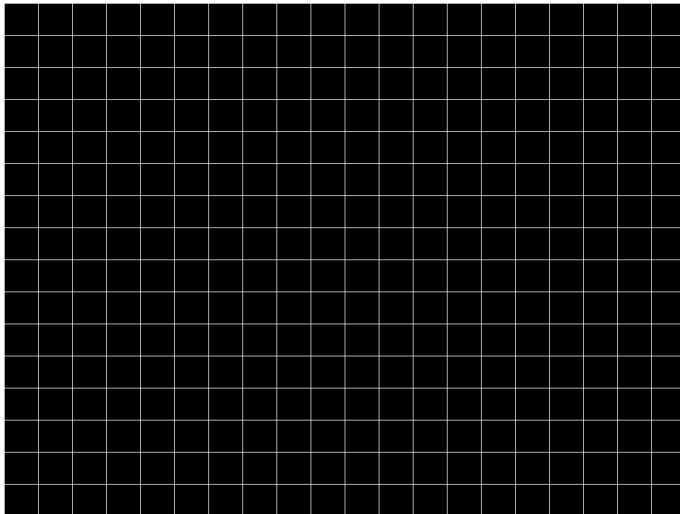

Hat2016A

Description Primary version is shown below. Secondary version is inverted.

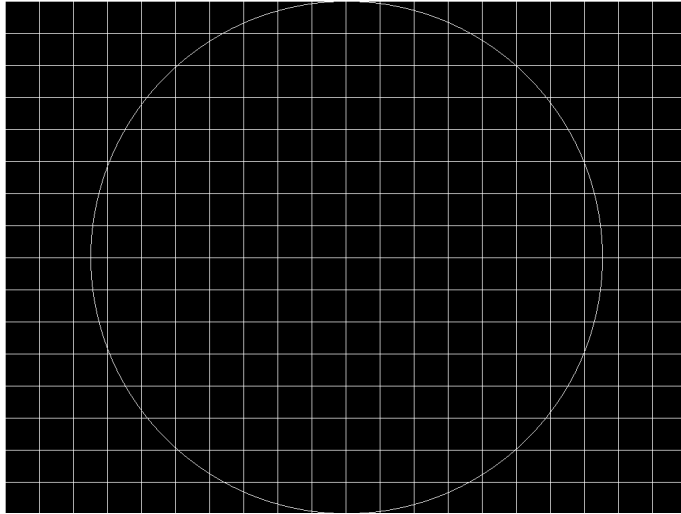

Hatch_6, Hatch_10i, Hatch_10o, Hatch_12i, Hatch_12o, Hatch_24i, Hatch_24o, Hatch_24s, Hatch_G, Hatch_M, GRN_HTCH, and MAGENTA

Description The primary versions consist of a white, green (G and GRN), or magenta (M) crosshatch drawn on a black background. The lines form square boxes. A single pixel dot is located in the center of each crosshatch box. The number of boxes formed depends on the version of the image selected and the screen aspect ratio of the currently loaded format. The number in the image's name refers to the number of boxes that are formed along the minor axis for most aspect ratios. The generator calculates the ratio and then finds the closest match from the table on the next page. Version names indicate the drawing method, as follows:

- Versions ending in "i" draw from the inside (center) out. Any partial boxes are placed around the perimeter of the image.
- Versions ending in "o" draw from the outside in. Any partial boxes are placed along the centerlines of the image.
- Versions ending in "s" are the "i" version plus a 1-pixel thick border.

The secondary versions invert the images to black lines and dots on a white background. Hatch_G, Hatch_M, GRN_HTCH and Magenta do not have secondary versions.

The primary version of the Hatch_10i image is shown below.

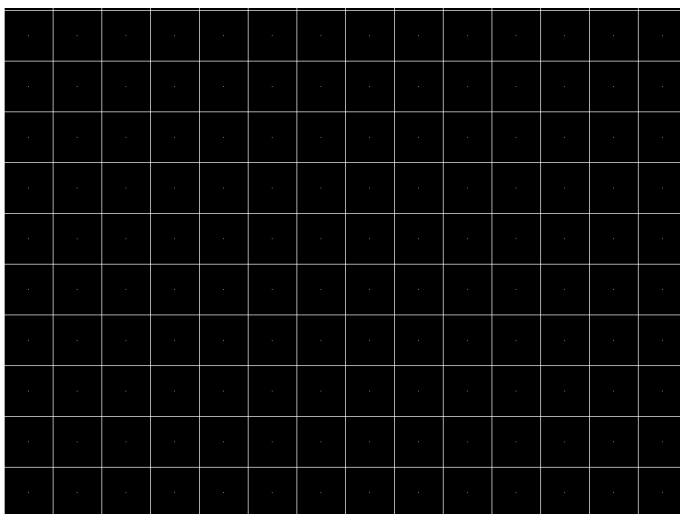

Aspect Ratio		Dot_10		Dot_12		Dot_24	
W : H	Decimal	Boxes Vertically	Boxes Horizontally	Boxes Vertically	Boxes Horizontally	Boxes Vertically	Boxes Horizontally
16 : 9	1.777 É	10	16	10	16	18	32
5 : 3	1.666 É	10	16	10	16	18	30
4 : 3	1.333 É	10	14	12	16	24	32
1 : 1	1.000	10	10	12	12	24	24
3 : 4	0.750	14	10	16	12	32	24

Test Convergence adjustment (color monitors only)

Purpose To accurately produce an image on a color monitor, the three electron beams in the CRT must meet (converge) at the same location at the same time. Lines displayed on a misconverged monitor appear as several multi-colored lines, and the transitions between different colored areas contain fringes of other colors.

Method The convergence adjustments of most color monitors fall into two main categories. The first set of adjustments, usually called Static Convergence, aligns the three beams in the center of the display. This method involves turning on all three guns and adjusting the various magnets on the convergence assembly to produce all white dots in the center of the display. The convergence assembly is located on the neck of the CRT. Different monitors and CRT types may each require their own magnet adjustment sequence.

After the center of the display is properly converged, the outer areas are adjusted by using the monitor's Dynamic Convergence controls. The number of controls, the area of the screen they affect, and their adjustment procedure depend on the monitor under test.

Hatch_16, Hatch_20

Description The primary version of the Hatch_16 image is shown below. The secondary versions draw black lines on a white background.

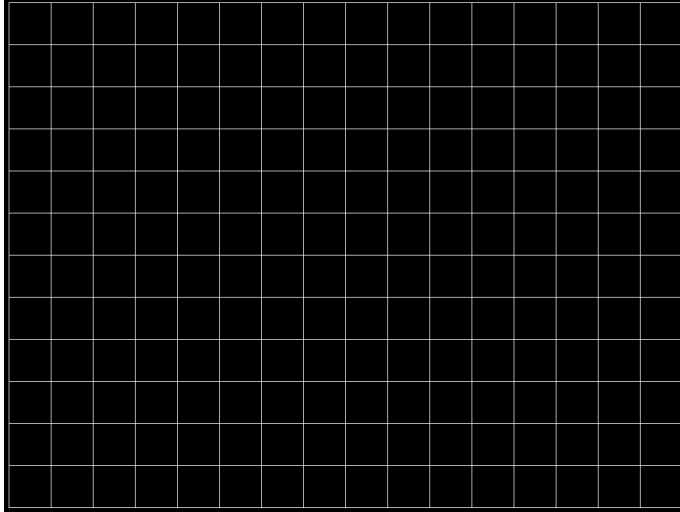

Hatch20

Description Primary version...The secondary version draws black lines on a white background.

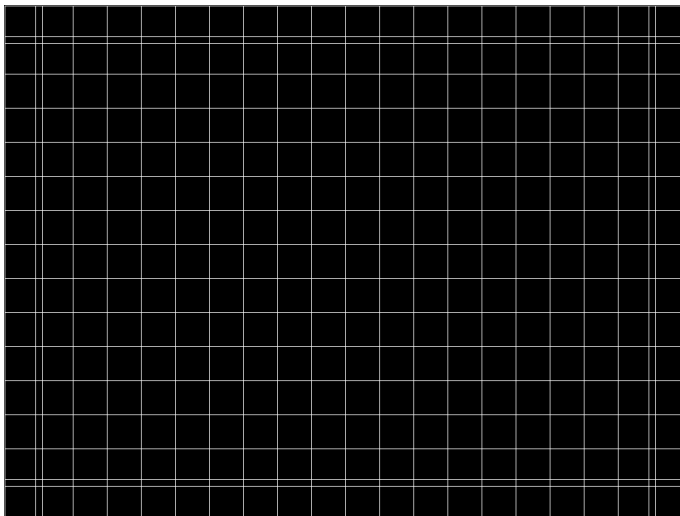

Hatch4x3, Hatch5x4 and Hatch8x8

Description These are different versions of a crosshatch pattern that may be called for by some display manufacturers' test procedures. The primary version consists of white crosshatch and circles on a black background. The secondary version inverts the image to black lines on a white background.

The primary version of the Hatch4x3 image is shown below.

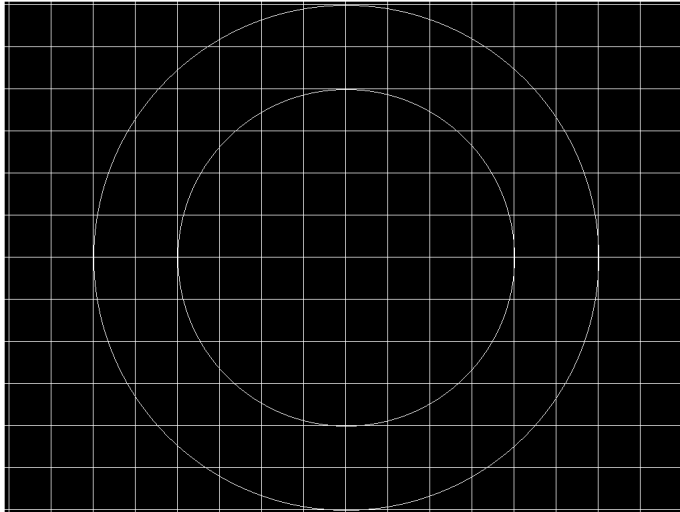

Purpose This is a general purpose test image that can be used to check and adjust video scan linearity and geometry and color convergence.

Hatch64W

Description This is a crosshatch pattern that may be called for by some manufacturers' test procedures. The primary version (shown below) consists of an 8x8 white crosshatch on a black background. A white rectangular patch is added in the center. The secondary version inverts the image to black lines and box on a white background.



Purpose

Method This is a general purpose test image that can be used to check and adjust video scan linearity and geometry, and color convergence. The large white rectangle also allows for checking a display's high voltage regulation. This is done by observing the vertical lines at the left and right edges of the image. They should be fairly straight and not pull in the area of the white rectangle.

HdcpA1B1, HdcpA1B2, HdcpA2B1, HdcpA2B2, HdcpProd

Description Used with HDCP feature. For more information, see Chapter 12, "[Testing HDCP on HDMI.](#)"

Hitachi1

Description Special test image developed per customer specifications. The image consists of a 2x2 cluster of Microsoft Windows® screen simulations using Japanese characters.

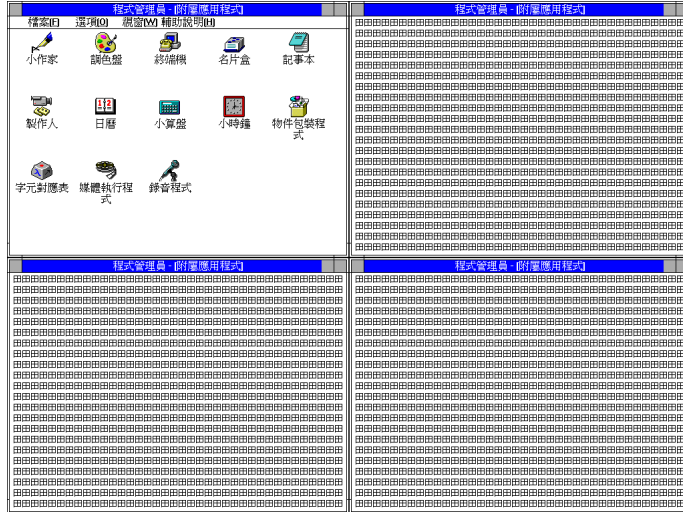

HSVnRGB

Description



Imex1

Description

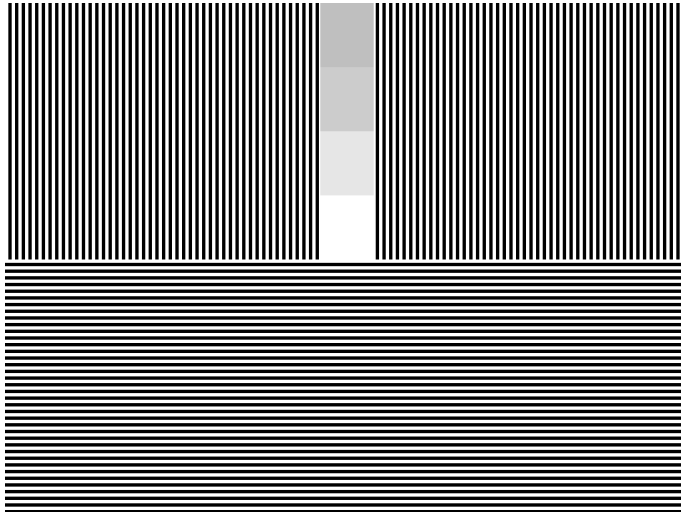

InFocus1

Description Special test image developed per customer specifications.



InFocus2

Description Special test image developed per customer specifications.

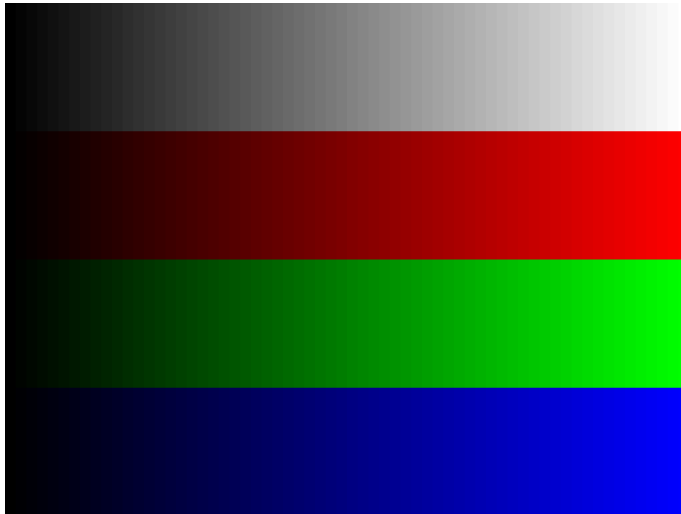

KanjiKAN

Description In the primary version (shown below), the screen is filled with white Japanese Kanji characters on a black background. The secondary version is drawn with black characters on a white background.

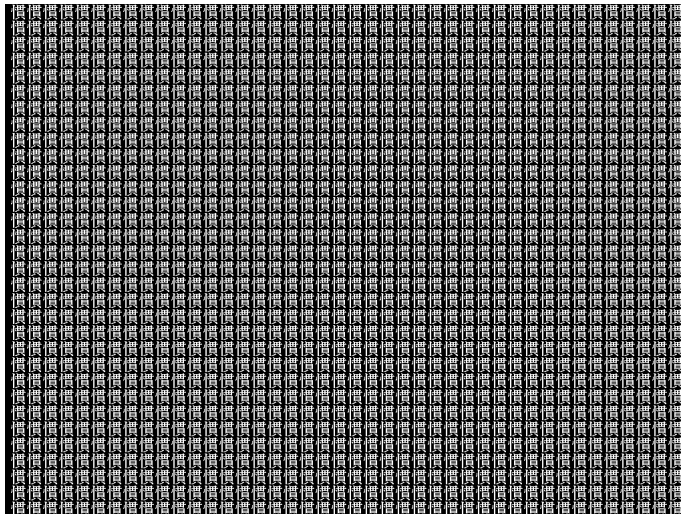

Test Focus adjustments

LGLCDTVB, LGLCDTVG, LGLCDTVR, LGLCDTVW

Description Special test image developed per customer specifications. Each image has three versions. The primary version of the LGLCDTVB image is shown below.

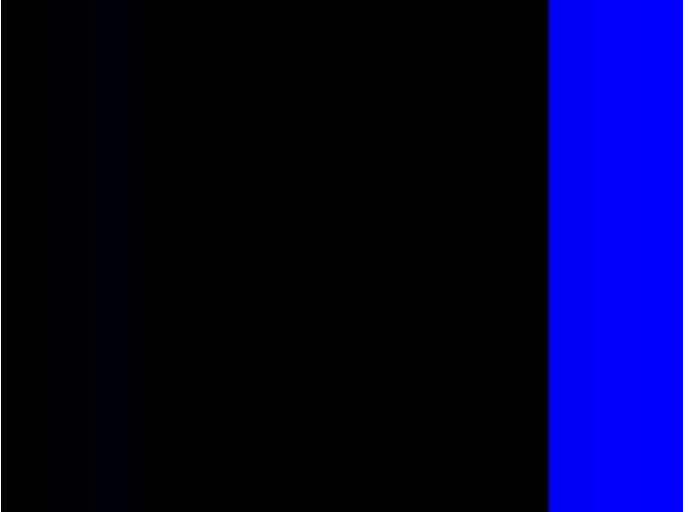

LGRamp

Description Special test image developed per customer specifications. The image provides a grayscale of two objects. The secondary version of the LGRamp image is shown below.

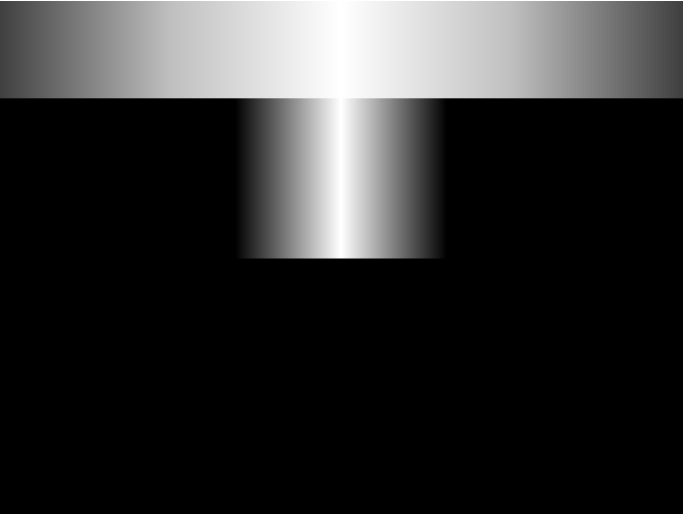

Linearty (Linearity)

Description This image has three parts. The first part consists of six (6) white circles. A large circle is drawn in the center of the screen. Its diameter equals the lesser of the video height or width of the display. A smaller circle is drawn at half the diameter and concentric with the larger circle. A circle also is drawn in each of the corners of the screen. The diameter of the corner circles equals one-fifth of the display width.

The second part of the image consists of a white crosshatch. The number of boxes in the crosshatch depends on the physical size of the display.

The last part of the image consists of white tic marks on the horizontal and vertical center lines of the image. The marks are one pixel thick at every other pixel location. Every fifth mark is slightly longer. The color of the pattern can be changed with the individual video output controls.

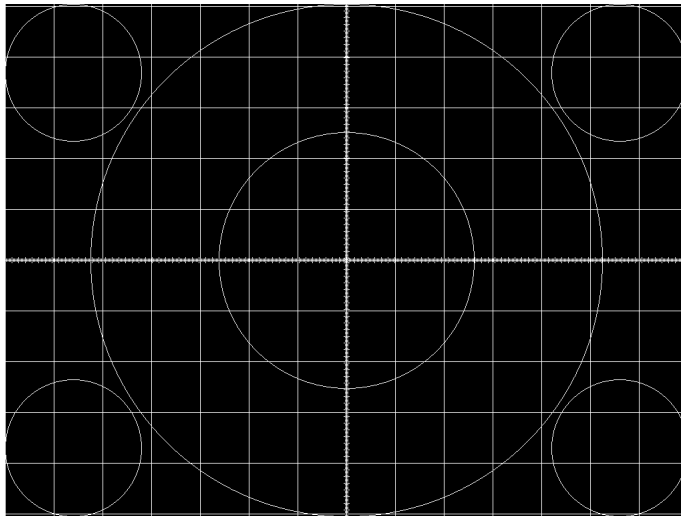

Test Linearity adjustment

Purpose To present an undistorted display, the horizontal and vertical sweeps of the electron beam across the face of the CRT should be at uniform speeds. Any non-uniformity in the sweep causes portions of an image to stretch while other portions are compressed. Non-linearity in a monitor shows up in several ways. It may be present across the entire screen, in a large portion of the screen, or localized in a very small area.

Method The circles in the image can be used to do a general adjustment of a monitor's linearity controls. Adjust the controls to form perfectly round circles. The crosshatch image can be used to measure linearity and to make finer control adjustments. All the full boxes in the crosshatch should be identical in size. Measure them with a ruler or a gauge made for the monitor under test. Any deviation should be within your specification limits. Use the tic

marks and a ruler or gauge to measure linearity over a small portion of the display. Compare the number of tic marks per unit of measure with an adjacent or overlapping area.

LinFocus

Description This image has several parts. The first part consists of a large circle in the center of the screen. Its diameter equals the lesser of the video height or width of the display.

The second part is a 10x10 box crosshatch. The crosshatch is drawn in from the outside edges, with any extra pixels in the boxes placed along the vertical and horizontal axis. The vertical centerline is two pixels thick if the format has an even number of active pixels per line. The horizontal centerline is two pixels thick if the format has an even number of active lines per frame. A smaller box is added at the center of the image. The box is one-half the height and two-fifths the width of one of the crosshatch boxes. Current format data is shown in the lower left quadrant of the image. It shows the number of active pixels (H) and lines (V) as well as the vertical and horizontal scan rates.

The primary version (shown below) consists of a white pattern on a black background. The secondary version has a black pattern on a white background.

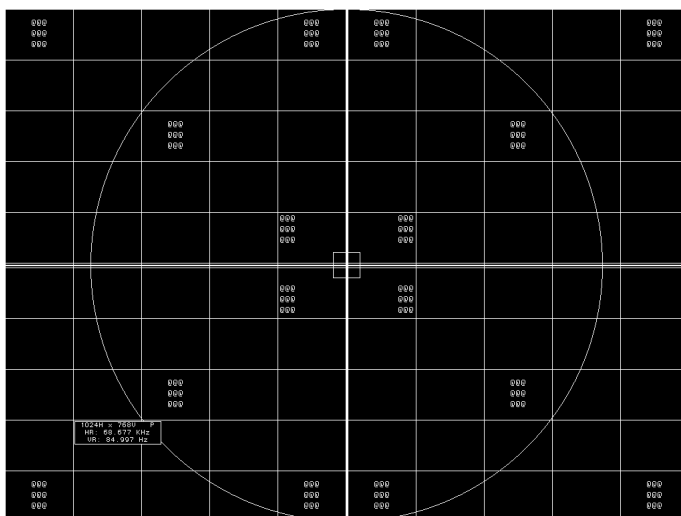

The image also includes blocks of focus-checking characters at various locations. The blocks are positioned inside the crosshatch boxes and are up to 3x3 characters in size. The size of the blocks is limited by the number of characters that can fit in one box.

Test Linearity adjustment

Method Please see the Linearity test image on “[Linearty \(Linearity\)](#)” on page 879 for information on measuring linearity.

Test Focus adjustment

- Purpose** An out-of-focus monitor displays fuzzy graphic images and poorly formed, hard-to-read characters when text is displayed on the screen.
- Method** On monitors with a single (static) focus adjustment, adjust the control for the best average focus over the entire screen. The focus at certain locations of the screen should be within specified limits.
- Some monitors have a static and one or more dynamic focus controls. The sequence for adjusting them and the areas of the screen they affect depend on the monitor under test.

LipSync

Description The lipsync image enables you to test for synchronization between HDMI video and audio. The image enables you to select between a range of intervals. You can access the subimages to control the interval of each video/audio synchronization event through the Content->Options menu and incrementing with the +/- keys. There are 255 distinct settings (different intervals) available.

When you first select the Lipsync image, the interval is set at 0.66733 sec per audio event (shown below) for progressive formats and 1.333333 sec for interlaced formats. When you enable subimages with Content->Option, the default initial screen at image rendition 0 is one sync event per 1.101100 sec for progressive formats and 2.2 sec for interlaced formats. You can increase this up to 8.475133 sec at image rendition 254 which is one video/audio synchronization event per 8.46666 seconds for progressive formats and 16.933332 for interlaced formats.

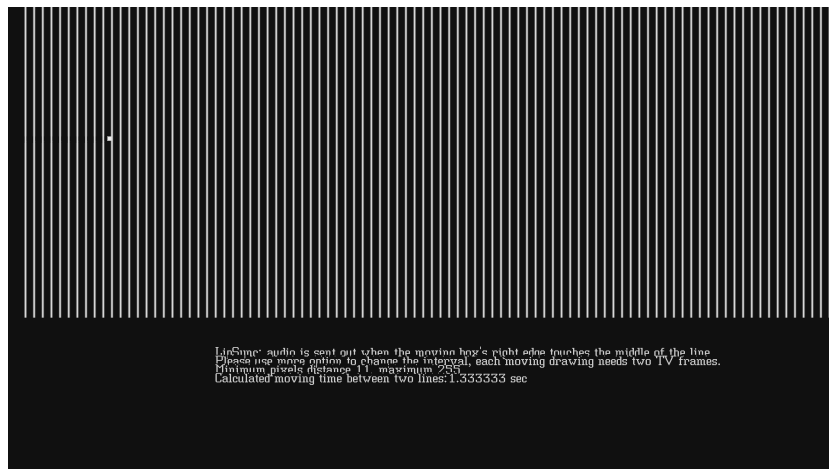

Master

Description

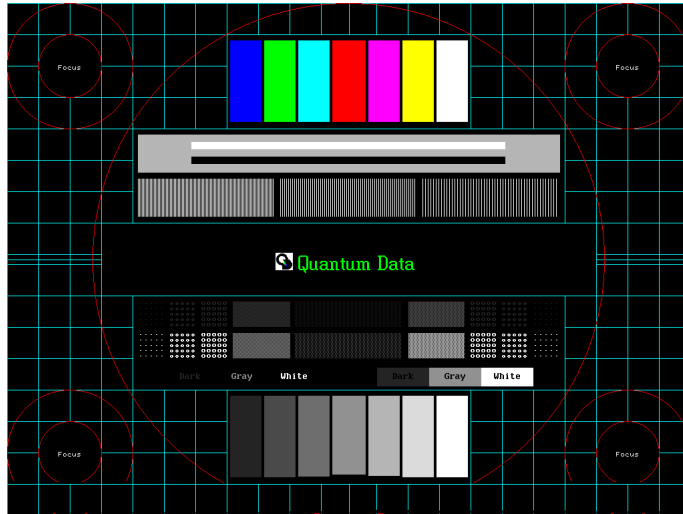

MEMEPlus, MEPlus_B, MEPlus_G, and MEPlus_R

Description In the primary version, the screen is filled with blue (BLU and B), green (GRN and G), red (R), or white (WHT and Sony) EM character blocks on a black background. Only the white character has a secondary version. It is drawn with black characters on a white background.

A bitmap of a single character block is shown here. The BLU_EM+ image is shown below.

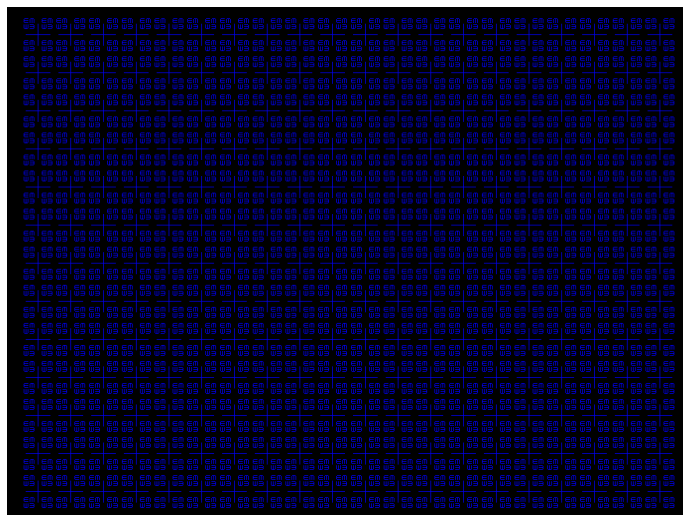

Test Focus

Purpose This pattern is specified by one or more display manufacturers for checking and adjusting focus one color at a time.

MoireX, MoireX33, MoireY, MoireY33

Description The MoireX and MoireY images consist of black lines on a white background across the active video area. MoireX provides vertical lines; MoireY provides horizontal lines. The MoireX image is shown below.

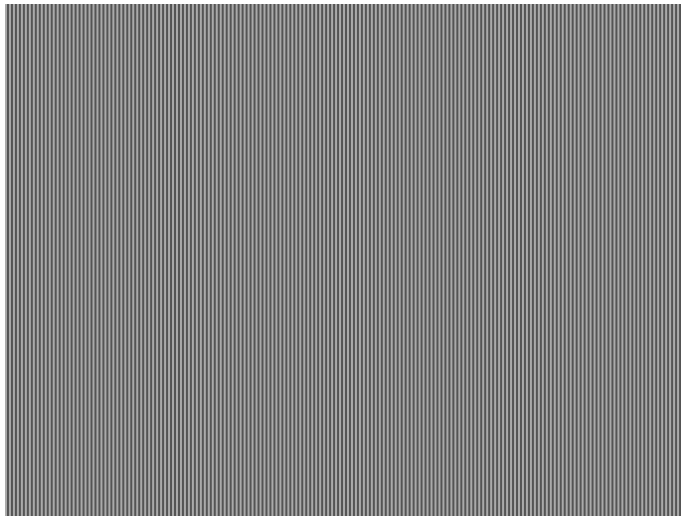

The primary version of the MoireX33 and MoireY33 images provide a black frame around the black lines. The secondary version draws a white frame around black lines. The primary version of the MoireX33 image is shown below.

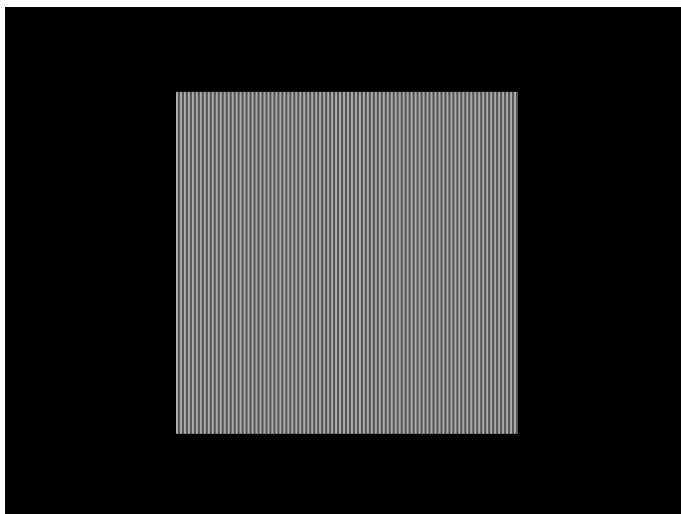

Monoscop

Description

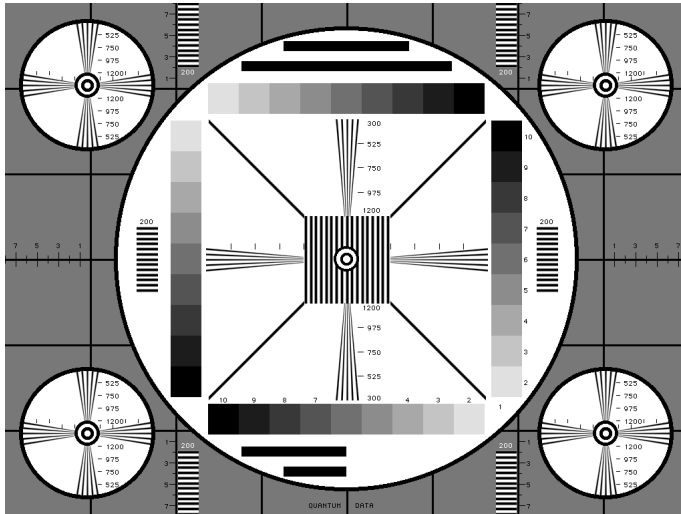

MSony7, MSony8

Description Special test image developed per customer specifications. Primary version of the MSony7 image is shown below. The secondary version draws white boxes and characters with a black background.

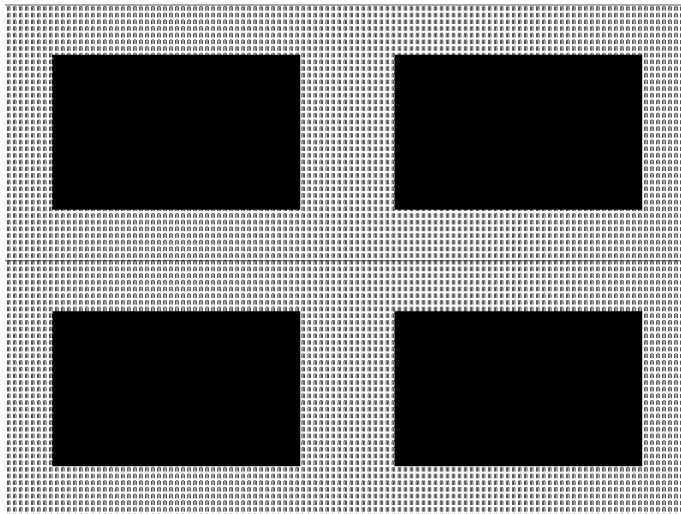

MulBurst

Description

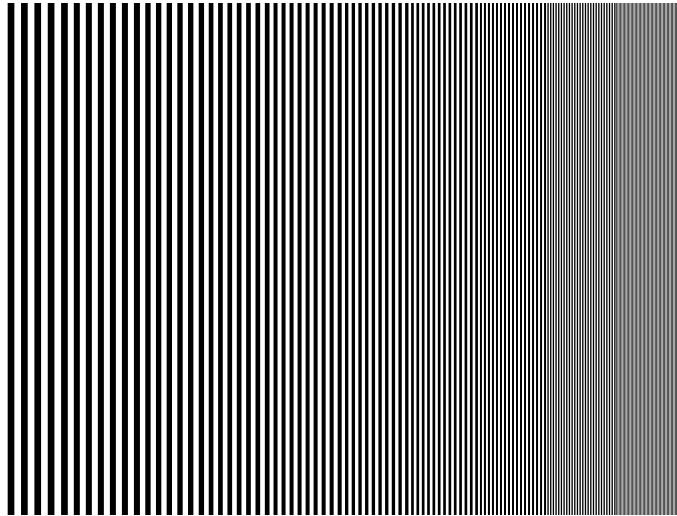

Orion

Description This image provides a color bar that rotates (shifts) the bars to the right on an incremental basis.

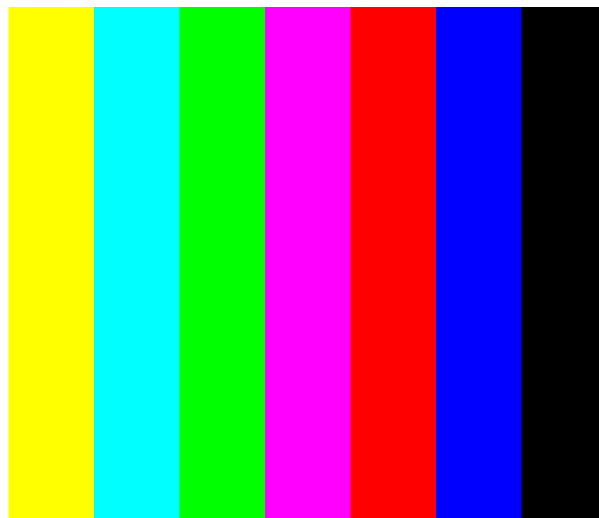

The color bars are shifted to the right at 3 second intervals. After pressing the Contents key and then the Options key you then enable More and use the +/- increment keys to proceed through the subimages to adjust the interval between 3, 10, 30 and 60 seconds.

Outline0, Outline1, Outline2, Outline3

Description The primary version of the Outline0 image consists of a rectangular white border on a black background. The border is one (1) pixel wide and defines the active video area. Two (2) diagonal lines join the opposite corners. A full size cross is centered in the image. The horizontal line of the cross is one (1) pixel thick for formats with an odd number of active lines and two (2) pixels thick for formats with an even number of active lines. The vertical line of the cross is one (1) pixel thick for formats with an odd number of active pixels per line and two (2) pixels thick for formats with an even number of active pixels.

The secondary version of these images draw black lines on a white background.

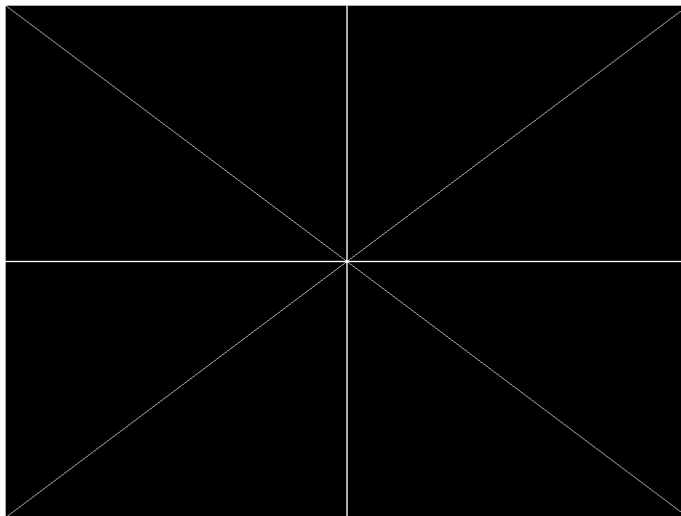

In the Outline1 version, the two diagonal lines are removed and short marker lines are added to the border lines near to where the cross lines meet the border lines. The markers appear at both sides of the cross lines. The distance between the marker lines and the cross lines is the greater of either two (2) pixels or one (1) millimeter.

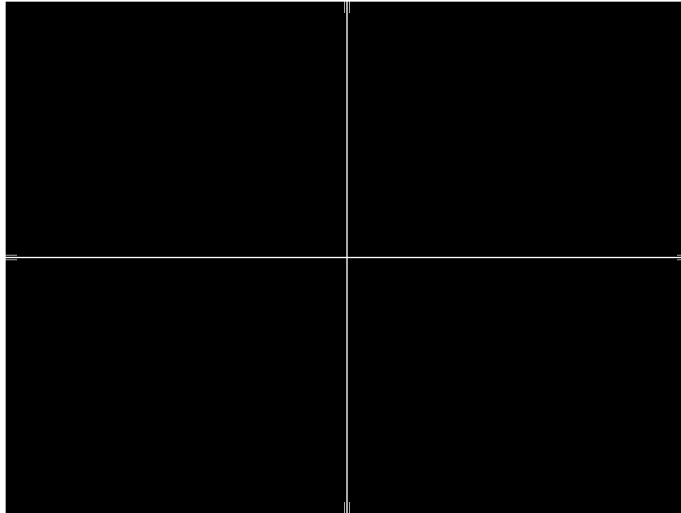

In the Outline2 version, the two diagonal lines are removed and short marker lines are added to the corners, and where cross lines meet and end.

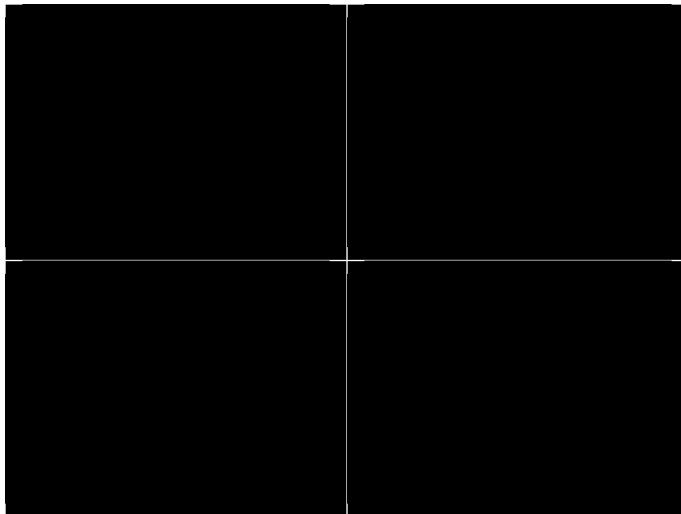

In the Outline3 version, the two diagonal lines are removed, cross lines are shortened, and short marker lines are added.

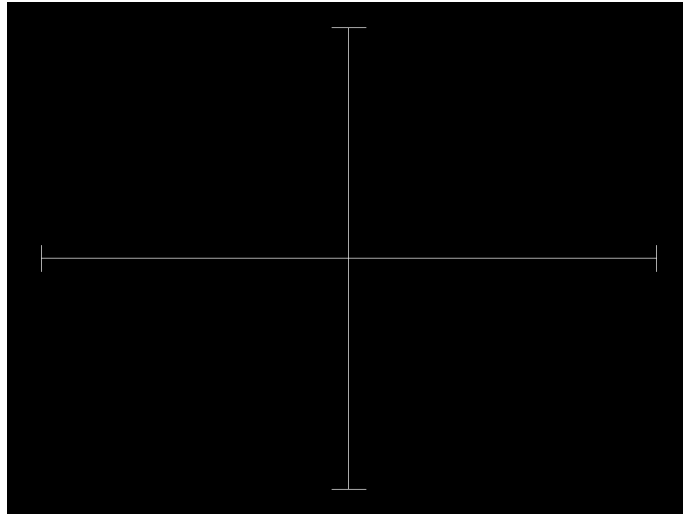

Test Yoke tilt correction

Purpose The horizontal axis of a displayed image should line up with the horizontal axis of your monitor. Any tilt is likely due to the yoke being rotated on the neck of the CRT. A rotated yoke makes any displayed image appear rotated.

Method Place your monitor on a flat surface so the face of the CRT is perpendicular to the surface. Use a ruler or gauge to measure the height of each end of the image's horizontal center line from the surface. The difference between the two readings should be within specification for the monitor. If it is out of specification, the yoke must be adjusted. Loosen the hardware that clamps the yoke to the neck of the CRT and rotate the yoke until the line is horizontal. Tighten the yoke-clamp hardware.

Test Yoke winding orthogonality check

Purpose The horizontal and vertical deflection coils on the yoke should have their axes cross at exactly 90 degrees. Improper orientation of the windings causes displayed rectangles to look more like nonorthogonal parallelograms. This type of defect is almost impossible to correct with adjustments. It is usually easier to replace the defective yoke.

Method First, perform the yoke tilt correction described above. The vertical center line of the image should be perpendicular to the work surface. If the deviation is beyond specification, the monitor should be rejected and sent back for repair, rather than trying to magnet a defective yoke.

- Test** Display size correction
- Purpose** A too-large active video size adjustment on a monitor may cause information to be lost around the edges of the screen. A too-small active video size adjustment may make some displayed information hard to read. The correct size is needed to obtain the correct aspect ratio. You need the correct aspect ratio to get round circles and square squares.
- Method** First, determine the correct physical size of the active video area for the display. This information usually is given in a display's specification sheet or service manual. The size should match the sizes in the format you are using. The size setting of the current format can be checked using the [Format](#) test image.
- Place a ruler or gauge along the horizontal line of the image and adjust the monitor's horizontal size control until the distance between the end points matches the specified value.
- Move the ruler or gauge to the vertical line and adjust your monitor's vertical size control until the distance between the end points matches the specified value.
- Test** Parallelogram distortion check
- Purpose** Parallelogram distortion is very difficult to correct with magnets because the correction often causes barrel distortion. Therefore, you should decide early whether your monitor meets this specification. The problem usually can be traced to the improper winding of the yoke coils. If the problem is not too severe, it may be corrected by adding or adjusting magnets on the yoke. However, if the distortion is excessive, it may be an indication of a defective yoke which cannot be corrected with magnets.
- Method** Measure the lengths of the two (2) diagonal lines. Any difference is an indication of parallelogram distortion. The difference in readings should be within the specifications of the monitor.
- If the difference in the readings is too far beyond specification, the monitor should be rejected and sent back for repair, rather than trying to magnet a defective yoke.
- Test** Trapezoid distortion correction
- Purpose** This image gives you a way to measure trapezoid distortion in your monitor. If the distortion is not too severe, you may be able to correct it by adding or adjusting magnets on the yoke.
- Method** Perform the yoke winding orthogonality check and parallelogram distortion check first to avoid wasting time on a monitor with a defective yoke.

Measure the width of the image at the top and bottom of the display. Any difference in readings should be within the specification limits. Measure the height of the image at both sides of the display. Again, any difference in readings should be within specification limits. If either of the differences is out of specification, the trapezoid distortion of the monitor is out of specification.

Add or adjust magnets on the yoke to correct the problem. The pin and barrel distortion correction should be repeated to make sure that it is still in specification.

Test Pin and barrel distortion correction

Purpose If perfectly linear sweep signals are sent to a perfectly wound deflection yoke mounted on a perfect CRT, you would not necessarily get a perfectly formed raster. Instead you would likely get a raster that had its corners stretched away from the center, resembling a pin cushion. This distortion occurs because the geometry of the deflected electron beam does not match the geometry of the tube face plate. Also, imperfections in the yoke or CRT may affect this problem. In some cases one or more corners may be pulled towards the center of the raster causing it to look like a barrel. Uncorrected raster distortion carries over as distortion of the displayed image.

Method A slot gauge may be used to determine if the amount of pincushion or barrel distortion is within limits. A basic slot gauge may consist of a piece of opaque film with at least two (2) transparent slots in it. One slot is used for top and bottom distortion and the other is used for the sides. By positioning the correct slot over each portion of the border line, the entire line should be visible. If this cannot be done at all four sides, the monitor requires correcting.

There are two main ways of correcting pincushion distortion. The first involves placing or adjusting magnets on the yoke. This is a trial-and-error method. However, skilled operators develop a feel for how strong a magnet to use and how to place it in order to get the desired correction. If any correction is performed, the trapezoid distortion correction should be repeated.

The other correction method involves adding correction signals to the deflection signal driving the yoke. This method is usually found in color monitors, where adding magnets to the yoke would cause problems with convergence and purity. The type and number of adjustments depends on the monitor being tested.

P1

Description This image is a 6x6 white crosshatch without a border on a black background.

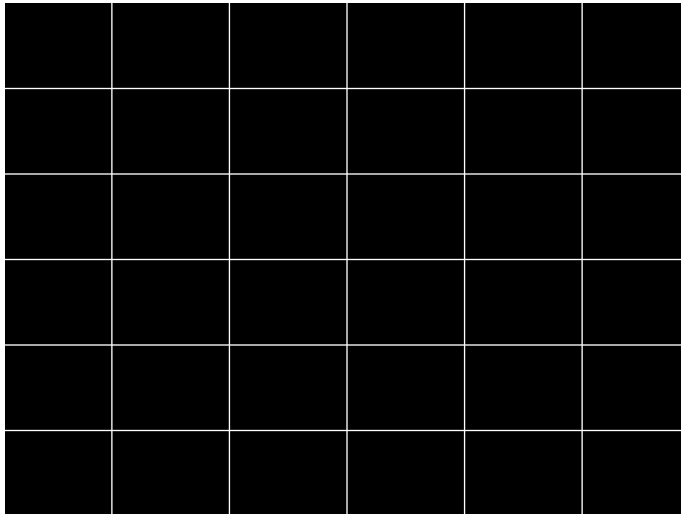

P2

Description This image is a 4x4 white crosshatch with a border on a black background.

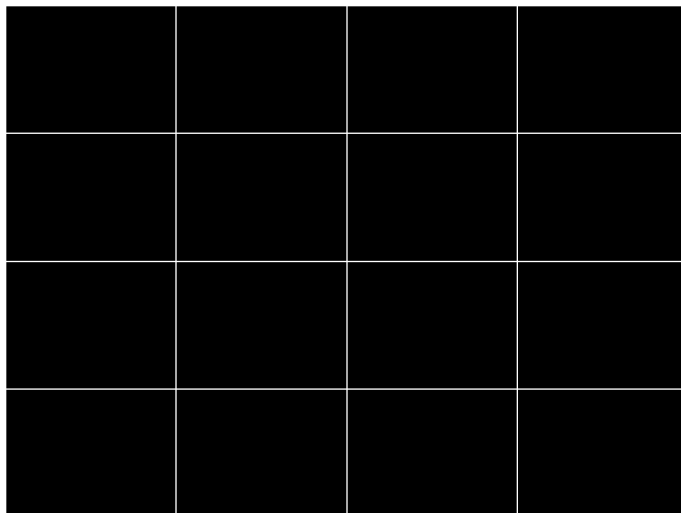

P3

Description This image is a 4x4 white crosshatch with a border and a small, centered white patch on a black background.

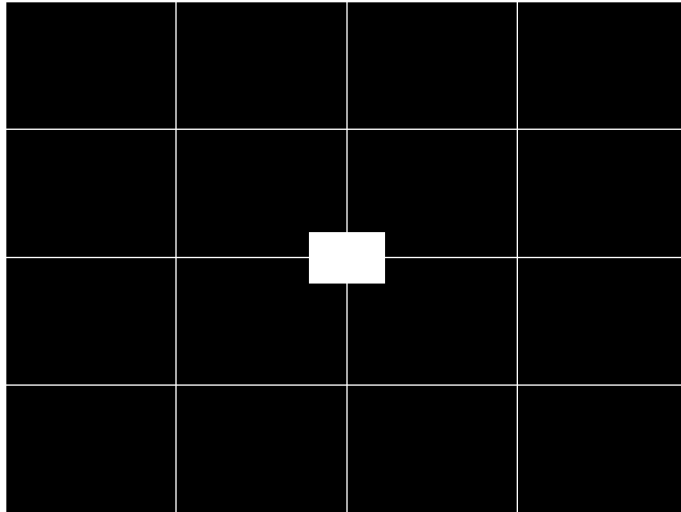

P4

Description This image is an 8x8 white crosshatch with a border on a black background.

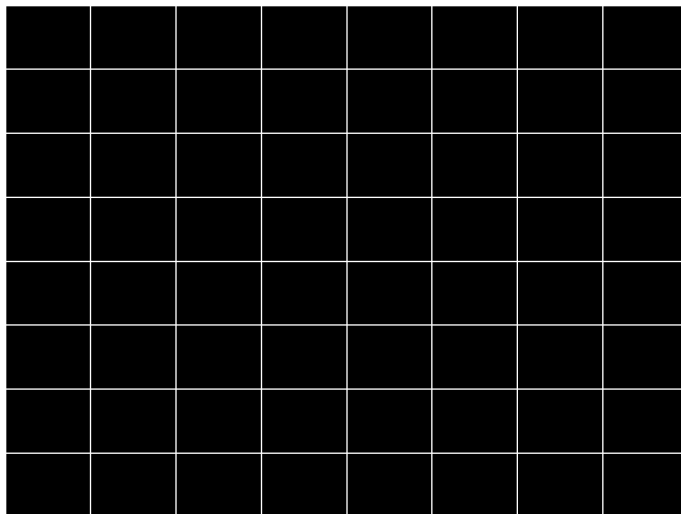

P5

Description This image is an 8x8 white crosshatch with a border and a small, centered white patch on a black background.

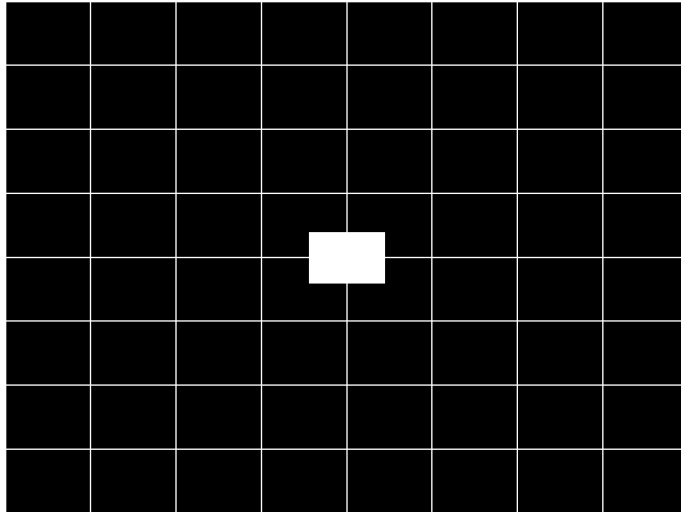

P6

Description 16x12 pixel white crosshatch with a border on a black background.

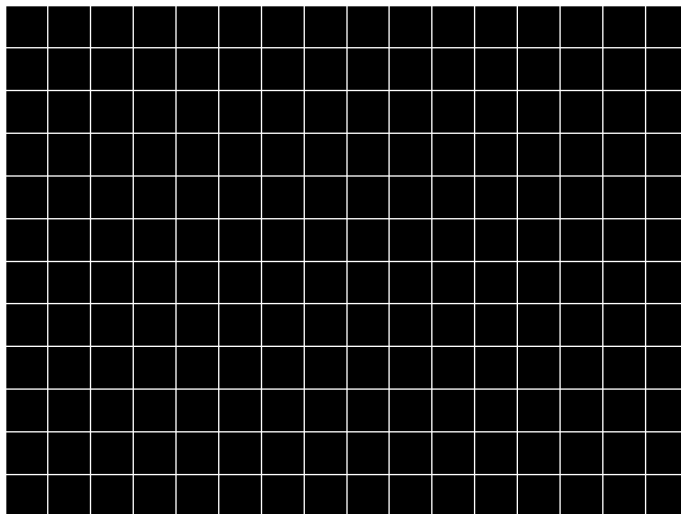

P6_Sony

Description 6x12 pixel white crosshatch with a border on a black background.

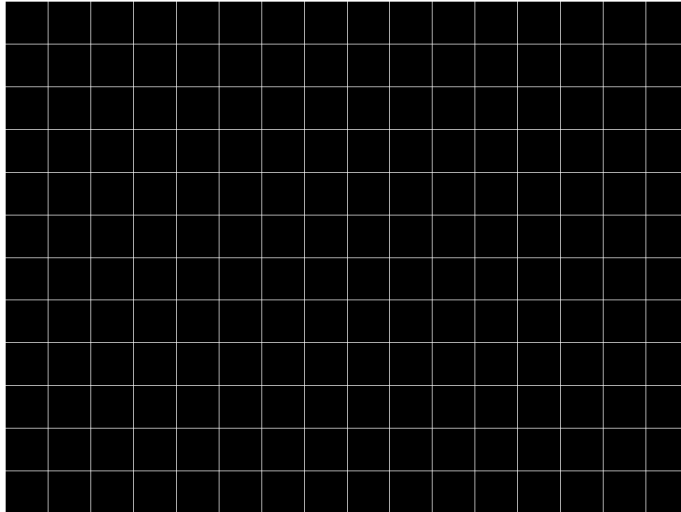

P7

Description 16x12 white crosshatch with a border and a small, centered white patch on a black background.

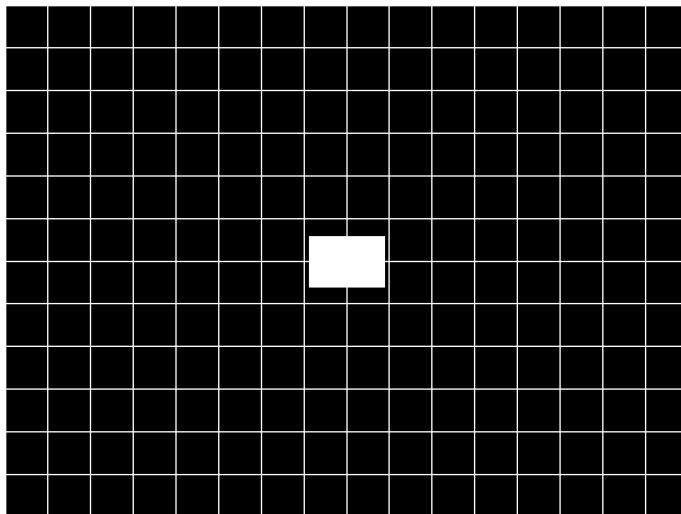

P8

Description This image is an all black active video area. The secondary version draws an all white video area.

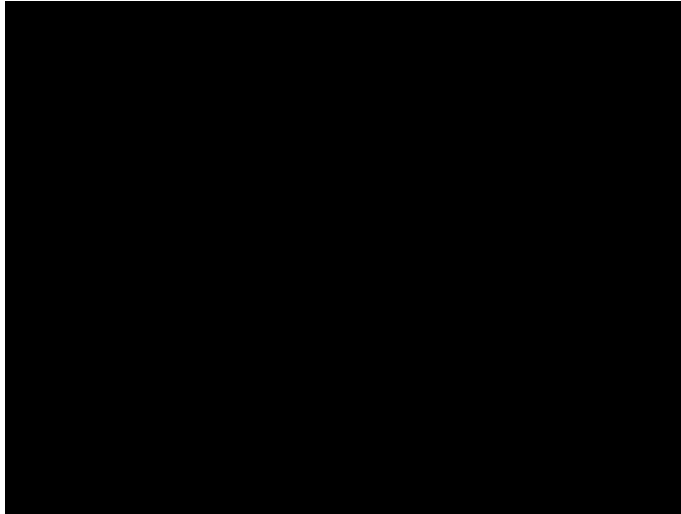

P9

Description This image is an all white active video area. The secondary version draws an all black video area.

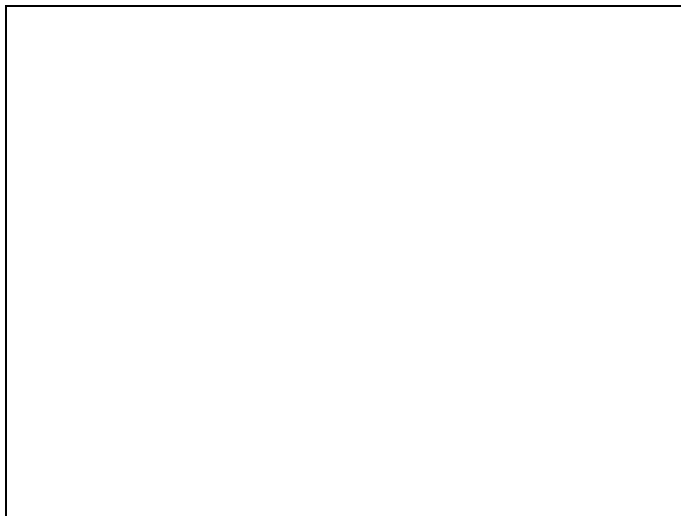

P10

Description Special test image developed per customer specifications. There are four versions of this image.

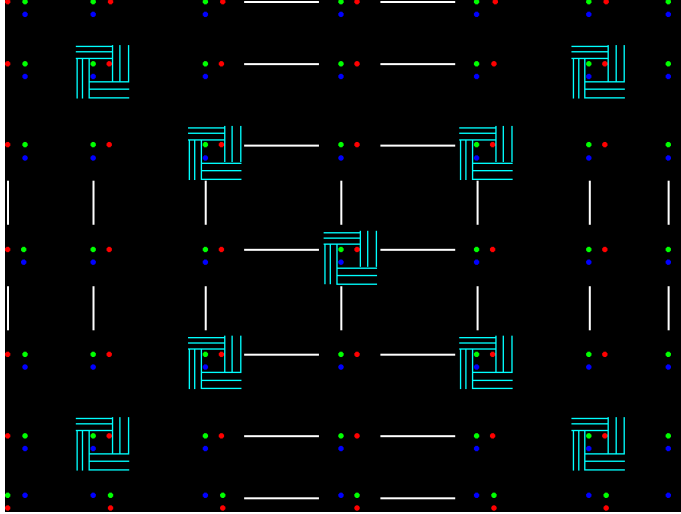

After pressing the Contents key and then the Options key you then enable More and use the +/- increment keys to proceed through the subimages to select up to 4 different versions of this image.

PacketRx

Description Displays the InfoFrame data received by HDMI receiver. For more information, see [“Testing HDMI transmit device InfoFrame capability”](#) on page 286.

PacketTx

Description Displays the InfoFrame data transmitted from the HDMI transmitter. For more information, see [“Viewing InfoFrame contents \(882 only\)”](#) on page 302.

PdsCrt1

Description Special test image developed per customer specifications.

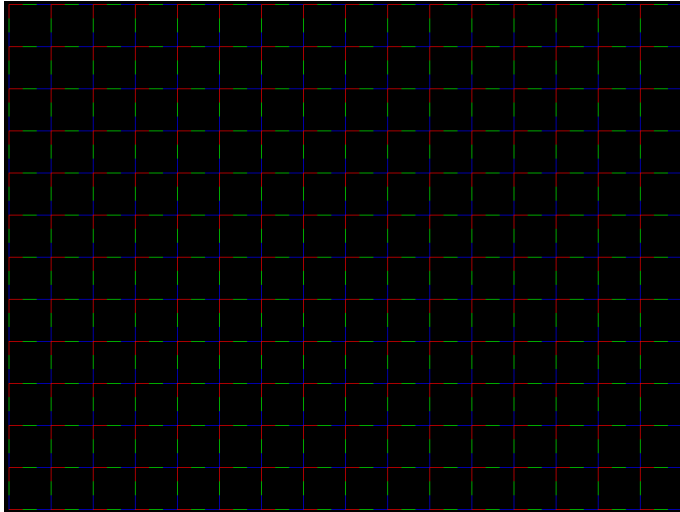

PdsCrt2

Description Special test image developed per customer specifications.

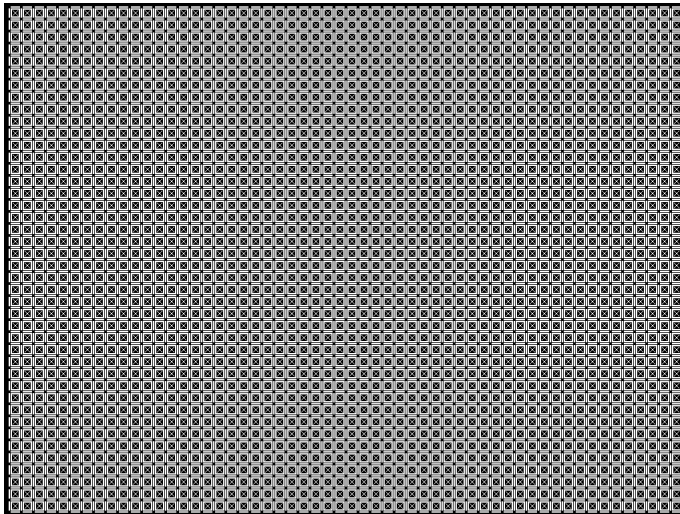

Persist

Description In the primary version, 15 small white boxes move back and forth between diagonal guide lines. The lines form 15 side-by-side tracks. The size of each box is scaled to the light meter box size set by the MSIZ system parameter. The image does the following:

- The box in the center track (marked “1X”) moves one scan line vertically and one pixel horizontally for each vertical frame of refresh.
- The seven boxes to the right of the center track (marked “2X” through “8X”) move 2, 3, 4, 5, 6, 7, and 8 pixels and lines per frame, respectively.
- The seven boxes to the left of the center track (marked “/2” through “/8”) move one scan line vertically and one pixel horizontally for every 2, 3, 4, 5, 6, 7, and 8 vertical frames of refresh, respectively. These boxes are at the bottom of the tracks.

In cases where the next move would cause the box to move beyond the end of its track, it immediately reverses and moves the correct distance in the opposite direction for the next frame.

A continuously-running counter appears in the upper left corner of the image. The number shown is the number of vertical frame refreshes that have occurred since the generator was first powered up.

The secondary version draws a black image on a white background.

An example of the primary version of the Persist image is shown below:

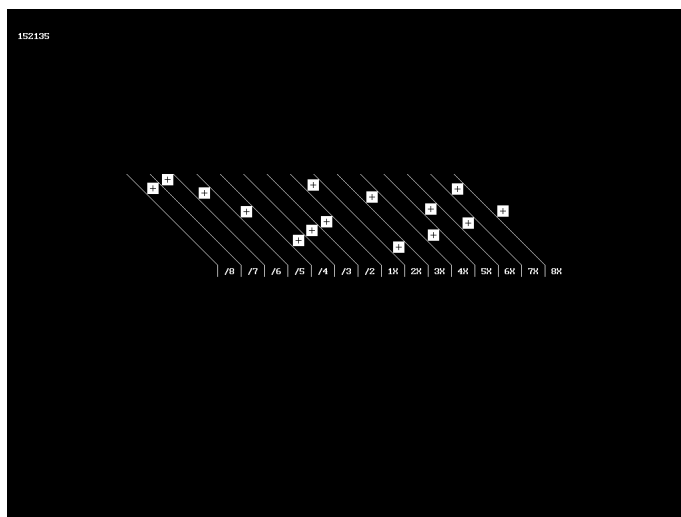

Test Phosphor persistence

Purpose The phosphors on the face of most CRTs continue to glow for a short period of time after the electron beam has stopped energizing them. This phenomenon is called persistence. A certain amount of persistence is desirable in most applications. It prevents a flickering of a displayed image that most users would find objectionable. On the other hand, a CRT with an overly long persistence time causes moving objects to leave a blurred trail.

Method A flickering in the slower moving boxes indicates that the combination of refresh rate and phosphor persistence is not suitable for long-term viewing.

A fading tail left behind by the faster moving boxes indicates that the display may not be suitable for viewing animated images.

PgBar64H, PgBar64V

Description Special test image developed per customer specifications. The PgBar64H image is shown below.

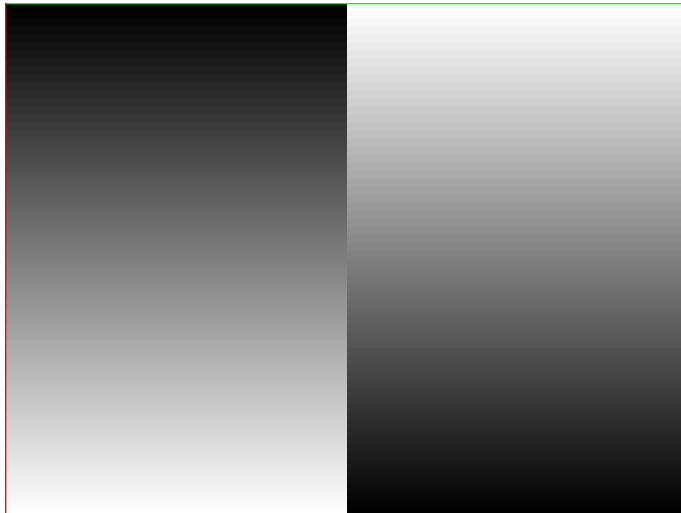

PgCB, PgCG, PgCR, PgCW, PgCWrgb

Description Special test image developed per customer specifications. Primary version of PgCB is shown below. The secondary versions draw all white over the last bar.

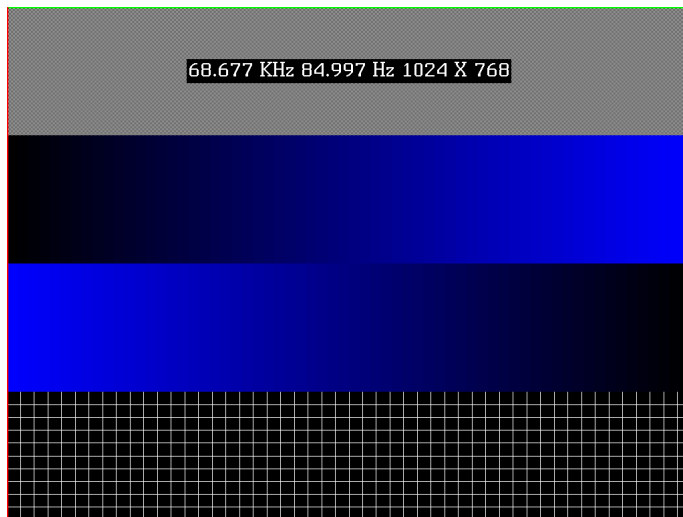

The PGCWrgb is shown below.

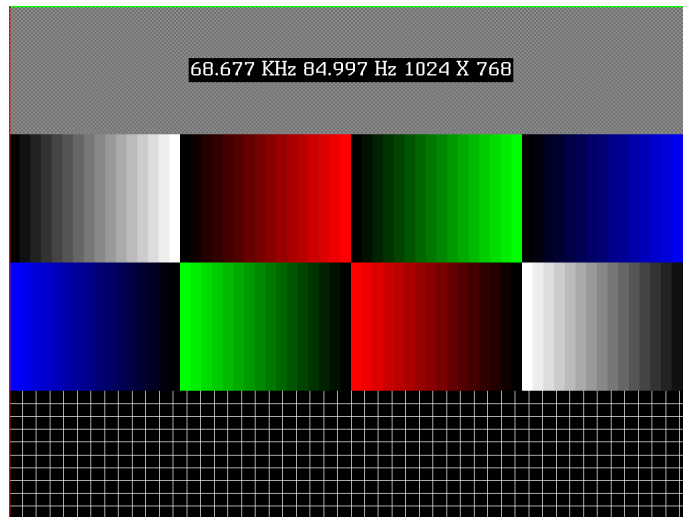

Philips1

Description Special test image developed per customer specifications.

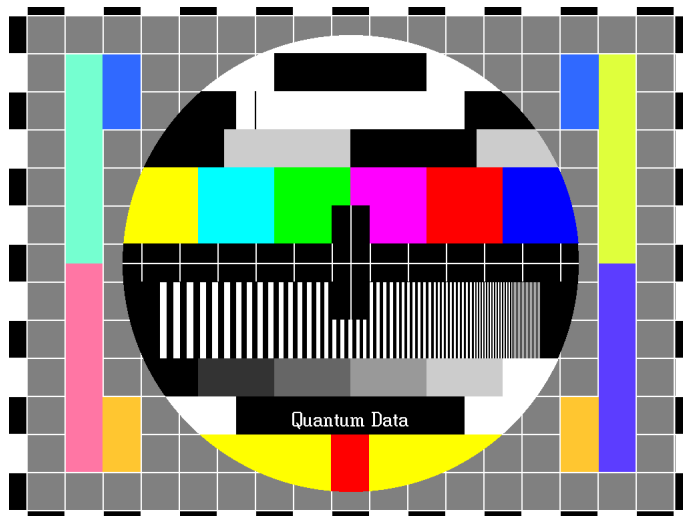

PixelRep

Description Used to test HDMI pixel repetition. There are 10 different versions of this image to support the different pixel repetition settings. For more information, see [“Testing HDMI video pixel repetition \(882 only\)”](#) on page 285.

PRN24bit

Description This image displays pseudo-random noise using 24-bits-per-pixel color depth.

PRN_5, PRN_9

Description Used with analyzer to verify the analyzer's pseudo-random noise analysis capability. The PRN_5 image introduces 5 pixel errors per color component, while the PRN_9 image introduces 9 pixel errors per color component.

The PRN_5 image is shown below.



PulseBar

Description This image is intended for TV formats, but can be displayed with any format up to 100 MHz. The image looks like two vertical lines followed by a wide vertical bar on a display's screen. The first line is a sine-squared modulated pulse that fades from black to red and

back to black. The pulse is 20 T for PAL and 12.5 T for NTSC formats. The second narrower line is a 2 T white sine-squared pulse. T = 100 nSec for PAL and 125 nSec for NTSC formats. The wide bar is white with sine-squared edges.



Test Video system testing

This multi-purpose pattern can be used with other instruments to check television K factors. The modulated pulse can be used to check chrominance-to-luminance delay and gain. The narrow white line can be used to measure short term linear distortion (K2T).

QuartBox

Description The primary version (shown below) has a single white box in the center of active video. The size of the box is one-half the width and height of the active video area (a quarter of the entire active video area). The secondary version draws a black box on a white background.

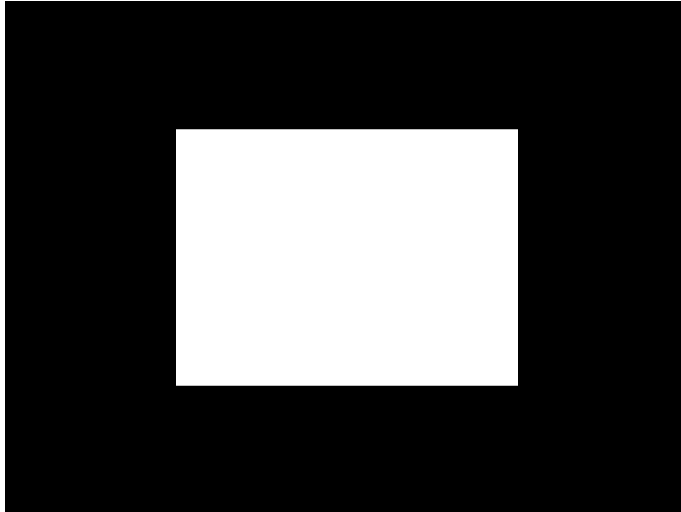

Test Brightness control adjustment

Purpose The wrong brightness setting on your monitor may cause other tests such as Contrast, Focus, and Beam Size to be invalid. An accurate brightness setting helps give repeatable measurements throughout other tests. This version of the brightness box should be used if the display's specifications call for the brightness to be set with one-fourth of the screen lit.

Method Place your light meter probe within the center box and adjust the monitor's brightness control to obtain the required light meter reading.

Notes The color of the center box is a special color, named foreground. The **FRGB** command can be used to change the default color of foreground to any RGB value.

```
IMGL quartbox: ALLU // loads QuartBox image
FRGB 122 122 122 // sets RGB color of box
```

After loading a different format, send the **FRGB** command again to set the box fill color.

If you want to draw your own box, use foreground as the fill color, and then use the **FRGB** command to define the color of "foreground." For example:

```
IMGL raster; ALLU // clears display
RECT foreground 100 100 100 100 dither100
FRGB 128 128 0
FRGB 192 192 64
```

FMTL DMT0660; ALLU
FRGB 192 192 64

Ramp

Description This image provides an active video area starting from full black (+7.5 IRE) at one edge of the screen to full white (+100 IRE) at opposite end of the screen.

There are 4 versions of this image—one for each edge of the display.

When selected, this image is displayed.



After pressing the Contents key and then the Options key. You then enable More and use the +/- increment keys to proceed through the subimages to change the image starting point to left, right, top, or bottom.

RampX

Description This image provides a ramp image that continuously sweeps (moves) to the right on an adjustable time basis.

When selected, this image is displayed.



After pressing the Contents key and then the Options key you then enable More and use the +/- increment keys to adjust the speed.

Ramp_B, Ramp_G, and Ramp_R

Description The active video area goes from full black (+7.5 IRE) at the left edge of the screen to full blue (_B), green (_G), or red (_R) at the right edge. The Ramp_B image is shown below.



Test Video gain linearity

Method When viewed on a TV screen, the full range of grays should be visible. There should be no color shifts visible.

Raster

Description The primary version shows a totally black display (nothing being displayed). The secondary version shows a totally white display.

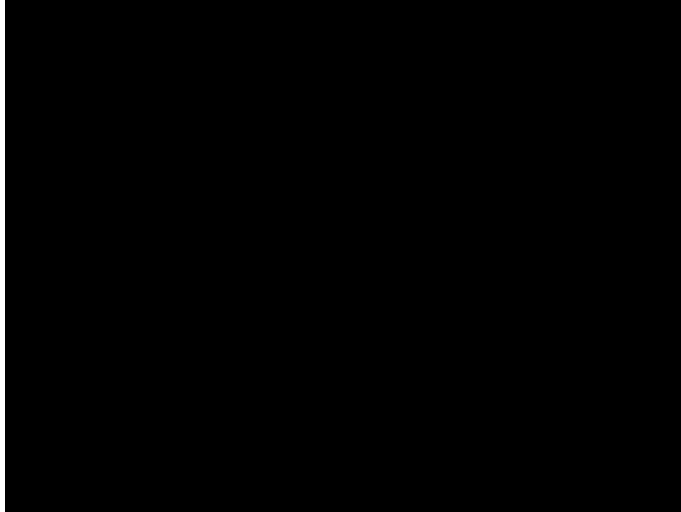

Test Raster centering

Purpose Many monitor applications require that the displayed image or text fit completely within a bezel that surrounds the CRT. This usually requires that you first center the blank raster on the face of the CRT, and then center the image within the raster. Use this image for centering the raster on the CRT.

Method Turn up your monitor's brightness control until the raster is just visible. Adjust the raster's position and size using the size and raster centering controls. The raster centering adjustment for many monochrome monitors consists of moving magnetic rings on the deflection yoke.

Regulate

Description The image cycles between two (2) patterns. In the primary version, the first pattern is a white outline that defines the edges of displayed video. The other pattern has the same outline plus a solid white rectangle in the center. The size of the solid rectangle equals 95% of the height and width of displayed video. The speed of the cycle cannot be changed. The secondary version has a thick white frame with a black center for the first pattern and a solid white active video area for the other pattern.

The first pattern of the primary version is shown below.



Test High voltage regulation

Method The size of the border should not change for each half of the image. The change in border size between the two images should be within the specification limits of the monitor.

Samsung1, Samsung2

Description Special test images developed per customer specifications. The image consists of three small simulations of Microsoft Windows® screens on a blue background (Samsung1) or black background (Samsung2). A border and centered cross are formed with repeating

groups of the characters “e” and “m”. The repeating characters are also used to form a rectangular patch in the upper left hand corner and a circular area in the center of the image. The secondary version of Samsung2 draws a white background.

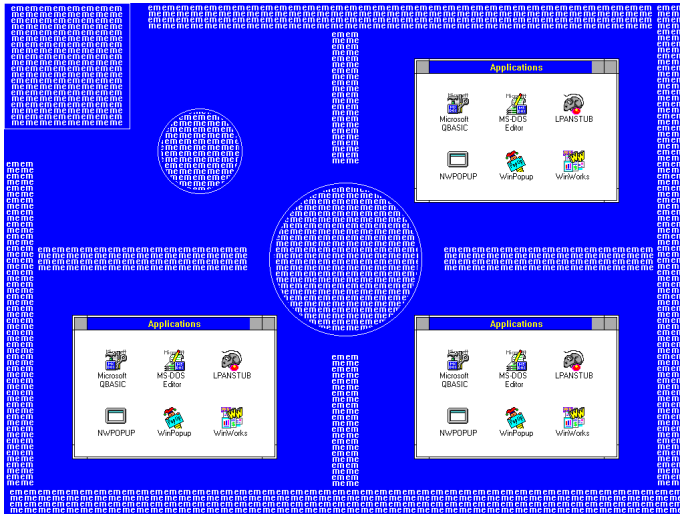

Samsung3

Description Special test image developed per customer specifications.

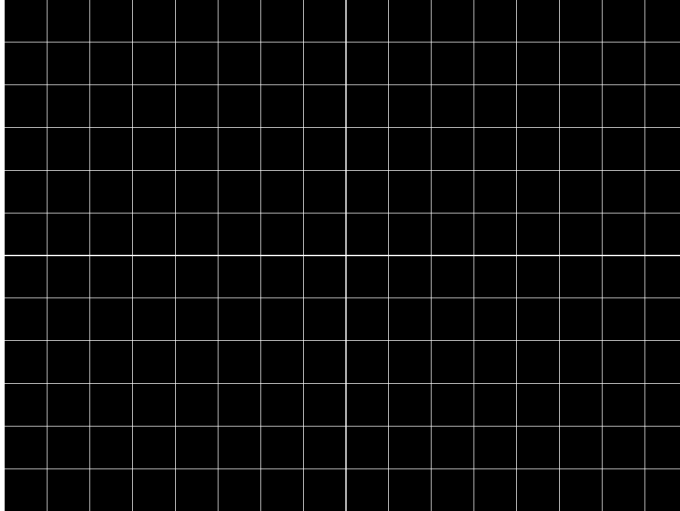

Samsung4

Description Special test image developed per customer specifications.

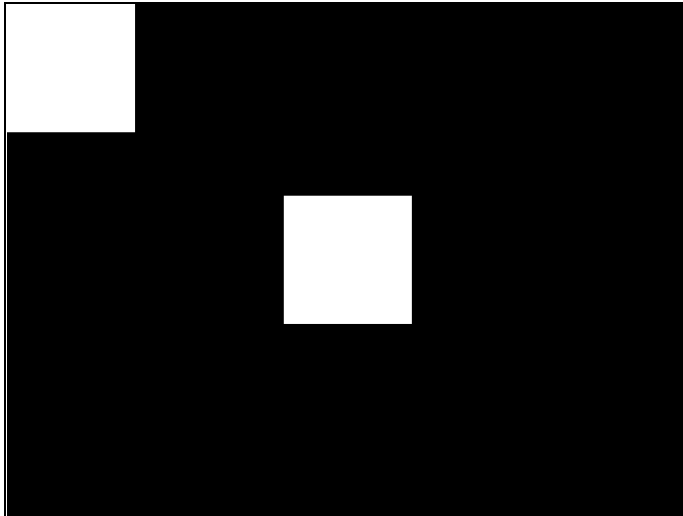

Samsung5

Description Special test image developed per customer specifications.

Samsung6

Description Special test image developed per customer specifications.

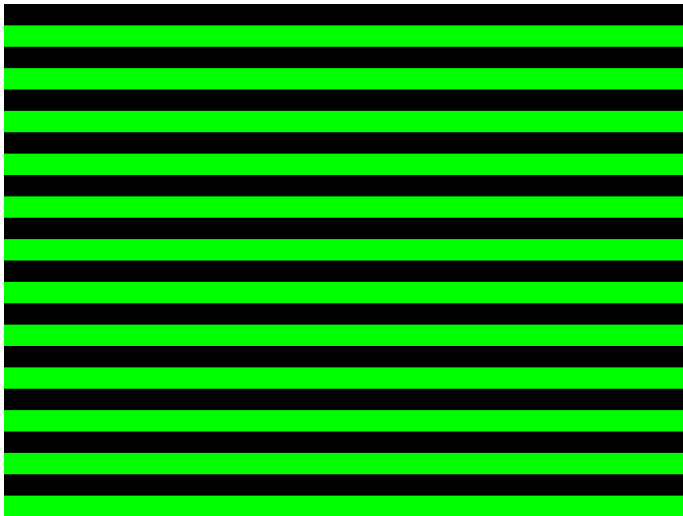

SamsungB

Description Special test image developed per customer specifications.

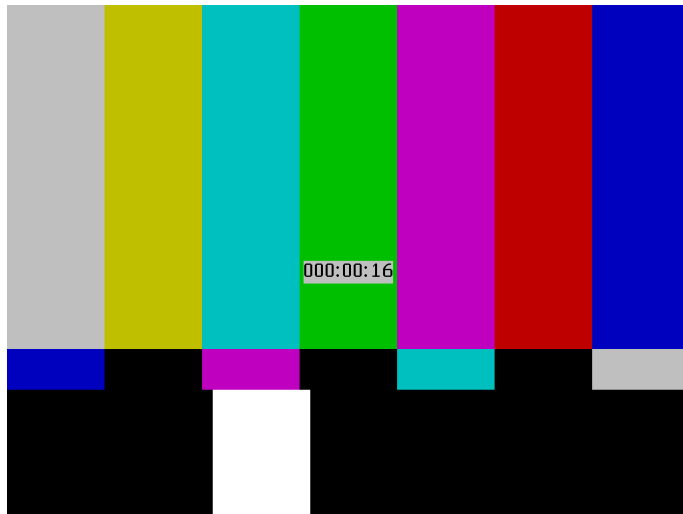

SamsungT

Description Special test image developed per customer specifications. There are four versions of this image. When selected, the following image is displayed.

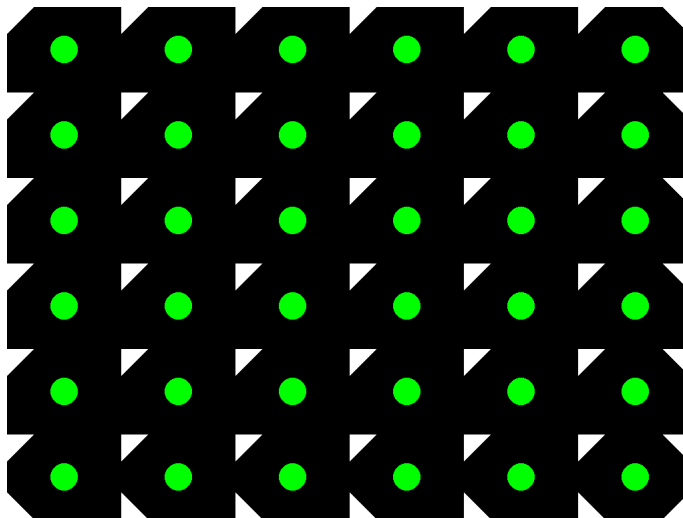

SlideBox

Description This image displays a 16x9 white crosshatch with a large white patch moving across the screen.

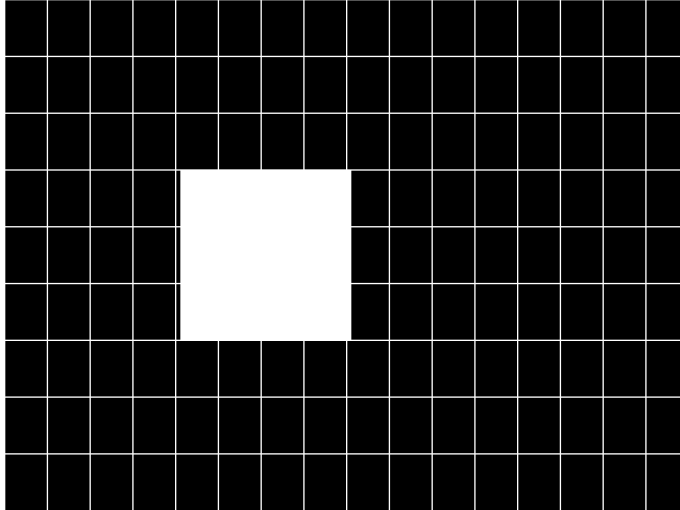

To change the animation speed:

1. Load the SlideBox image.
2. Establish a terminal session with the generator (see page 30).
3. Enter the following commands:

```
ISUB 1  
IVER 1  
IMGU  
DELX 10;  
IMGU  
DELX 20;  
IMGU
```

SMPTE133

Description This image is based on a recommended practice (RP-133) test pattern designed by the Society of Motion Picture and Television Engineers (SMPTE). The original application was used in testing and evaluating medical imaging monochrome displays. The image now is

used in many different display applications. The image is self-scaling as to the number of active pixels and active lines used. Some of the image's elements have minor differences from the original SMPTE specification.

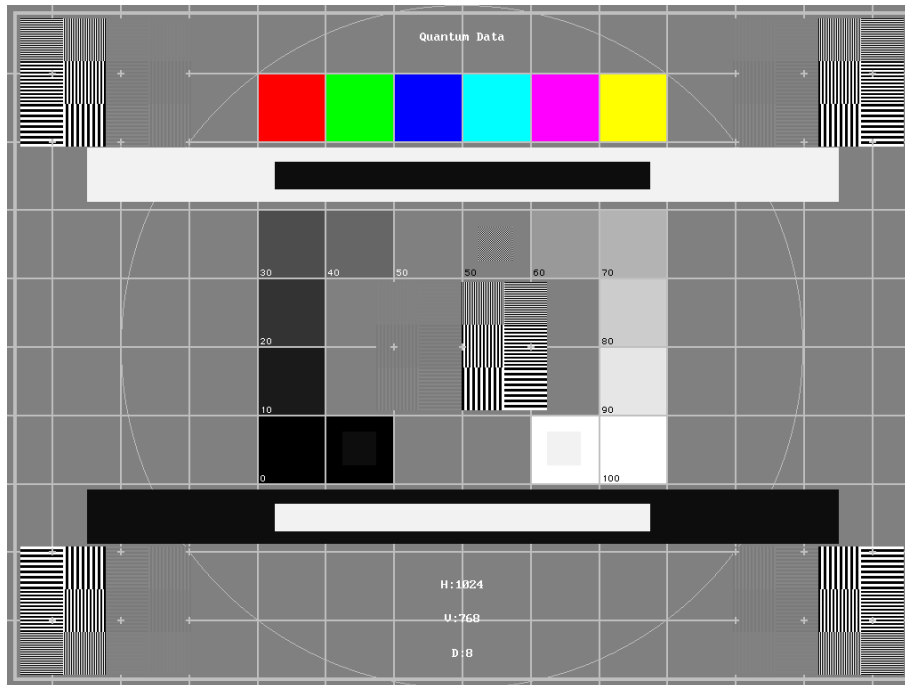

These differences are noted in descriptions of the individual elements.

- The image is drawn on a reference background having a 50% intensity level. The background covers the entire active video area.
- **Crosshatch** – There are 10 boxes vertically. The number of horizontal boxes is based on the physical aspect ratio determined by the [HSIZ](#) and [VSIZ](#) parameters in the currently loaded format. The boxes are perfectly square with any fractional spaces placed around the outside edges of the image. The vertical lines are two (2) pixels thick while the horizontal lines are two (2) scan lines thick. Small crosses indicate the intersection of the horizontal and vertical lines when they are covered by other parts of the image. All parts of the crosshatch are normally drawn using a 70% intensity level. A 75% level is used in the secondary version.
- **Resolution patch** – The patch is made up of six (6) smaller boxes that are each about 6.25% of the height of the display. The boxes are made of alternating intensity (0 and 100%) stripes. The stripes run vertically and horizontally. The stripes may be one (1), two (2) or three (3) pixels wide each. Details of the patch are shown in the lower half of the following illustration. The patches are located in each corner of the main image and in the center. They are oriented with the highest resolution and contrast boxes closest to the outside corners. The 48%-53%, 48%-51% and 50%-51% level patches are omitted in the secondary version.
- **Grayscale boxes** – Twelve (12) boxes at eleven (11) intensity levels are clustered around the center of the main image. They start at 0% and increase in 10% steps to

100% with two (2) boxes at a 50% level. All of the grayscale boxes are omitted in the secondary version.

- **Gamma check dither box** – A small box is drawn inside the right-hand 50% grayscale box. The box is half the width and height of the larger box. The box consists of a checkerboard of alternate one-on and one-off pixels. The alternate pixels have levels of 0 and 100%. This smaller box is not part of the original SMPTE specification and is omitted in the secondary version.
- **Contrast boxes** – Two (2) boxes are drawn adjacent to the grayscale boxes. They are at 0 and 100% levels. There are smaller boxes drawn inside each box at 5 and 95% levels. The contrast boxes are omitted in the secondary version.
- **Black and white windows** – Two (2) horizontal bars are located above and below the grayscale boxes. Their height equals 8% of the display height. There are half-size bars centered in the larger bars. In the primary version, the dark portion of the windows is at a 5% level and the bright portion is at a 95% level. Zero and 100% levels are used in the secondary version.
- **Border** – A border line is drawn around the image. It is set in from the edges of displayed video a distance equal to 1% of the displayed height and has a thickness equal to 0.5% of the displayed height. The intensity level is the same as that of the crosshatch lines.
- **Circle** – A large circle is centered in the image. It touches the top and bottom of the active video area when the aspect ratio is wider than it is high (landscape-type display). The circle touches the left and right sides of active video when the aspect ratio is taller than it is wide (portrait-type display). The intensity level is the same as that of the crosshatch lines. The circle is not part of the original SMPTE specification.
- **Resolution data** - The number of active pixels per line and the number of active lines is shown as text below the lower black and white window. The pixel depth also is shown. The intensity level of the text is the same as that of the crosshatch lines. The displaying of the data is not part of the original SMPTE specification.

The secondary version adds a row of six (6) color bars above and below the black-and-white windows. The order of the colors, from left to right, is red, green, blue, cyan (g+b), magenta (r+b) and yellow (r+g). The top row is drawn at 100% intensity levels and the bottom row is drawn at 50% intensity levels. Color bars are not part of the original SMPTE specification.

Test Deflection linearity

Method If the overall height and width of the display's active video area match the sizes in the format, the large circle should be perfectly round. Each box in the crosshatch pattern should be the same size and shape. For more information on testing linearity, refer to the Linearity test image on page 879.

- Test High contrast resolution
- Method All the 0 and 100% level stripes in all the resolution patches should be separate and distinct.
- Test Low contrast resolution and noise
- Method All the mid-level 2 on - 2 off stripes in all the resolution patches should be visible and distinct. This is a sensitive test for noise in the display's video amplifiers.
- Test Quick gamma check
- Method The average brightness level of the small gamma dither box should match the brightness of the larger surrounding box. This is a visual check to see if the display's gamma correction is producing the correct mid-level response.
- Test Video gain linearity and gamma
- Method The individual grayscale boxes all should be at their indicated levels. A small aperture photometer is usually required to get accurate and repeatable readings.
- Test Contrast and brightness check
- Method On a display with properly adjusted brightness and contrast controls, both the 5% and 95% contrast boxes should be clearly visible inside their larger surrounding 0% and 100% boxes.
- Test Video amplifier stability
- Method The two black-and-white windows should show sharp transitions between the smaller box and the surrounding window. Streaking may be an indication of undershoot or overshoot while ghost images may indicate a ringing problem.
- Test Excessive overscan and off-center alignment
- Method The entire border should be clearly visible on the face of the tube and not be hidden by the edge of the glass or by any bezel.
- Test Interlace flicker

Method The horizontal 1 on - 1 off stripes in the resolution boxes should not have objectionable flicker when shown with an interlaced format. Excessive flicker indicates that the combination of the display's CRT persistence and frame scan rate is below the persistence time of the human eye.

SMPTEbar

Description This image is based on an engineering guideline (EG1-1990) test signal specified by the Society of Motion Picture and Television Engineers (SMPTE). The SMPTE pattern, in turn, is derived from an EIA standard test pattern (RS-189-A). The image, is set up to be generated by an 801GX generator as an encoded TV output. It is designed for adjusting the color settings of a television monitor by eye. It can also be used with a TV waveform analyzer and vectorscope for testing video signal processors and color decoders. The image is available on all models as a component RGB signal. Some of the image's elements have some differences from the original SMPTE specification.

These differences are given in descriptions of the individual elements.

- The upper 67% of the image consists of a series of color bars. These bars match the order of the bars in the SMPTE and EIA patterns. They are similar to the 801GX's TVBar_75 image without the last black bar.
- The left side of the lower 25% of the image contains isolated -I and Q color difference signals that match the original EIA and SMPTE patterns. The -I signal appears as a bluish-gray bar and the Q signal appears as a purple bar on a TV monitor. The bars are separated by a white (+100 IRE) bar.
- The right side of the lower 25% of the image contains a narrow 12.5 IRE gray bar. Due to a hardware limitation on the 801GX, this portion of the pattern does not match the original EIA and SMPTE patterns. The original patterns had +3.5 (blacker than black) and +11.5 IRE bars separated by a +7.5 IRE (black) bar.

- The remaining central 8% of the image contains a row of chroma set bars. These bars are part of the SMPTE pattern but are not in the EIA pattern. The order of the alternating color and black bars matches those in the SMPTE pattern.



Test Color video performance

Purpose This general purpose pattern can be used to check the video handling capabilities of most parts of a television system.

Method When viewed on a TV screen, all of the upper color bars should be correct and in the order shown. The hue and intensity of each bar should be uniform over the entire bar.
The image can be used with a TV waveform analyzer to check the performance of a video system. The upper color bars, as they would appear on a waveform analyzer, are shown on a previous page.

Test Color decoder performance

Purpose The image can be used with a TV vectorscope to check for proper operation of a video color decoder. Vectorscope signatures of the upper and lower portions of the image using NTSC encoding can be found on the previous page.

Method The vectorscope signature for the color bars should hit the target test point for each color on the vectorscope's graticule. If you are using PAL encoded video, the signature will be similar to the one shown for the TVBar_75 test image on page 924.

The three "legs" of the vectorscope signature for the -I and Q color difference signals should match the Burst, -I and Q reference lines on the vectorscope's graticule.

The following tests are based on the original SMPTE guideline:

Test Visual chroma gain adjustment

Method To perform this test, you must have a way of turning off the red and green guns in the monitor under test. Turning off the red and green video components of the 801GX generator's video output will not work for this test.

This test uses the upper and central color bars. Switch off the red and green guns on the monitor. This will produce four blue bars, separated by black bars. Adjust the chroma gain so that the brightness of each outer blue bar is uniform over the entire bar. The gain is correct when the bottom 10% of each bar is the same brightness as the rest of the bar.

Test Visual chroma phase adjustment

Method In order to perform this test, you must have a way of turning off the red and green guns in the monitor under test. Turning off the red and green video components of the 801GX generator's video output will not work for this test.

This test uses the upper and central color bars. Switch off the red and green guns on the monitor. This will produce four blue bars, separated by black bars. Adjust the chroma phase so that the brightness of each of the two central blue bars is uniform over the entire bar. The phase is correct when the bottom 10% of each bar is the same brightness as the rest of the bar.

Test Visual black level adjustment

Method This test uses the lower right hand portion of the image. Reduce the black level until the gray bar disappears. Slowly increase the black level until the bar just becomes clearly visible.

Sony6

Description Special test image developed per customer specifications.

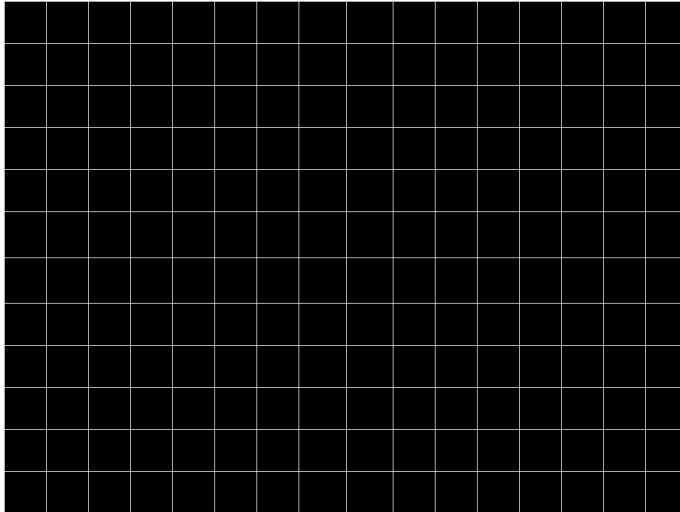

Sony6WLC

Description Special test image developed per customer specifications.

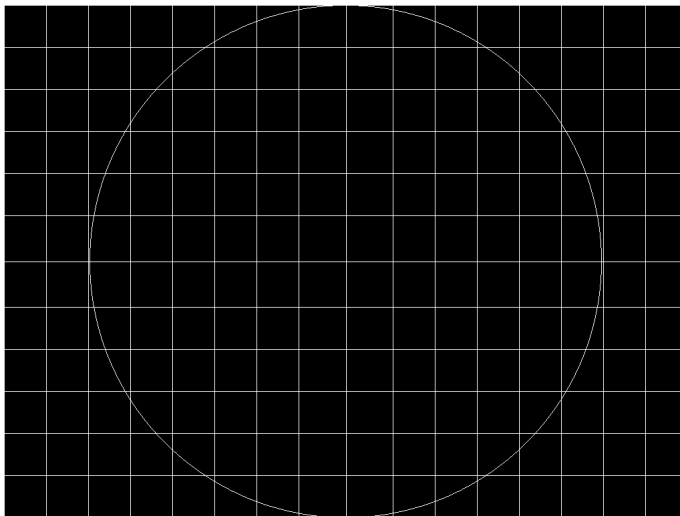

sRGBflat

Description For testing color response per Microsoft's WinColorKit standard. This standard was developed by Microsoft to standardize methods relating to the matching of colors appearing on various displays (go to <http://www.microsoft.com/whdc/hwdev/tech/color/ColorTest.msp> for more details). There are 38 different versions of this image to support this feature.

When selected, a flat image appears with a color that is remembered from the last time the image was set up. The example below shows version 8 (Red1) of the sRGBflat image:



A small label in the upper left corner of the image indicates the Microsoft name for the color that is currently being displayed (for example, "sRGB-Gray5"). Note that some of the names that appear conflict with generator color names (for example, "sRGB-Gray5" is not the same as the generator color "Gray5").

After pressing the Contents key and then the Options key. You then enable More and use the +/- increment keys to select up to 38 different versions of this image. Each image displays another WinColorKit color.

Note: For more information of generator support for Microsoft WinColorKit, go to <http://www.quantumdata.com/support/kb/article.asp?kbid=100152>.

Staircas, Stairs20

Description The active video area goes from full black at the left edge of the screen to full white at the right edge. There are six (6) steps (Stairs20) or sixteen (16) steps (Staircas).

The Stairs20 image is shown below.

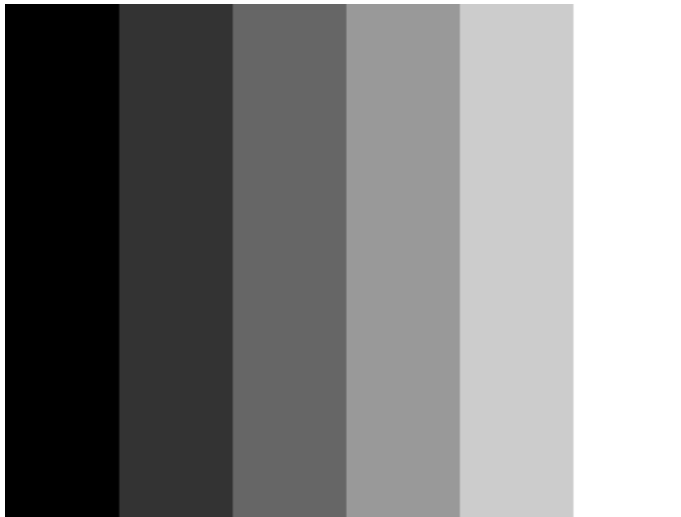

Test Video gain linearity

Method When viewed on a monitor's screen, a black bar plus five (5) gray bars should be visible. There should be no color shifts, and each of the bars should be uniform in color.

The image also can be used with an oscilloscope or TV waveform analyzer to check the gain linearity and gamma correction of a video system.

Strokes0, Strokes1

Description This image may be cited by some display manufacturers' test procedures. The Strokes0 version consists of multiple groups of separated red, green and blue horizontal lines drawn on a black background. The Strokes1 version consists of multiple groups of separated red, green and blue diagonal lines drawn on a black background.

Purpose If your monitor is used in word processor workstations or other applications that call for large amounts of text to be displayed, you can use this image to simulate actual user conditions.

Method Select a suitable font size and text color. Adjust your monitor's brightness and contrast controls to obtain the best image. The characters in all areas of the display should be well formed and in focus.

TAARamp

Description The TAARamp pattern is shown below.

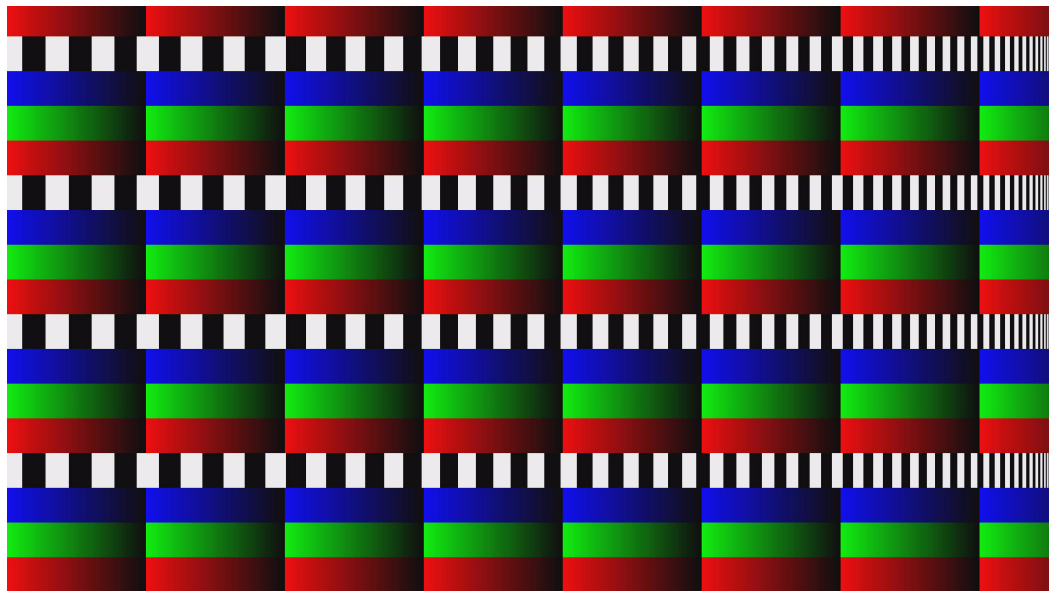

TintAlign

Description



Toshiba

Description Special test image developed per customer specifications. There are two sub images, the secondary image is depicted below. The top half of the image has three small boxes (red, green, blue) with the upper left half at 92.7% luminence and the upper right half at 50% luminence. There is a series of 11 small boxes of increasing luminence left to right with the luminence identified in text. The lower left quarter of the image is 28.5% luminence and the lower right is magenta at 44.3 IRE.

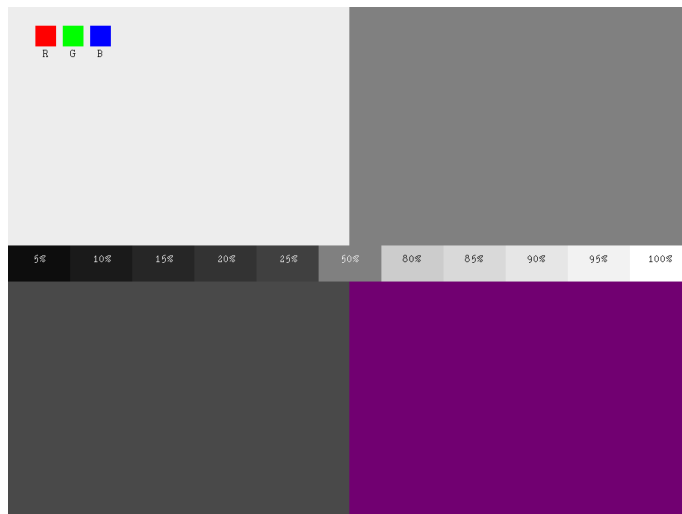

TPVAOC1 and TPVAOC2

Description The TPVAOC1 pattern is shown below.

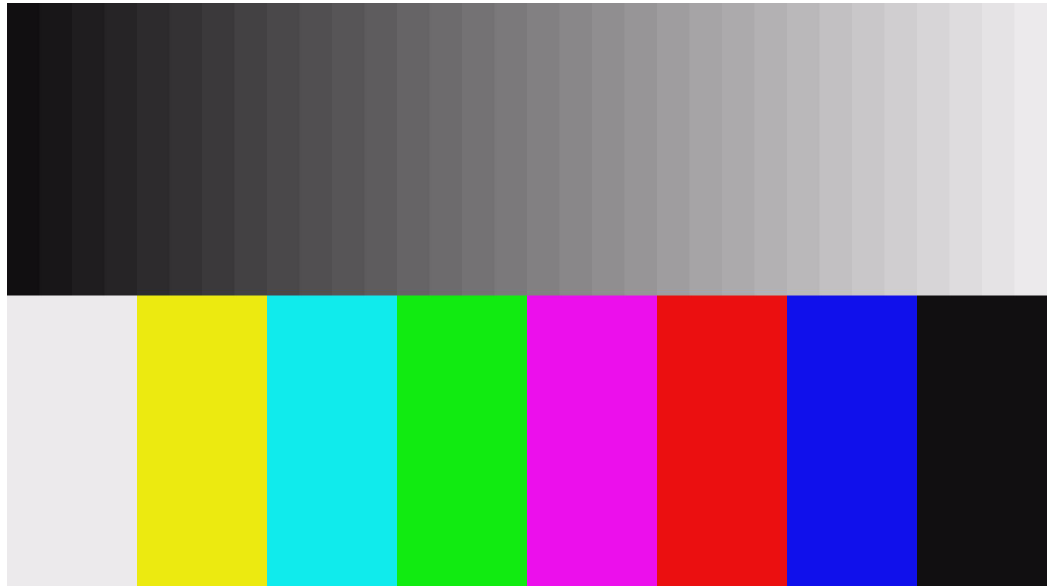

TVBar100 & TVBar_75 (TV formats only)

Description The image consists of seven vertical bars that fill the entire active video area. The color and order of the bars is shown in the figure below. The TVBar100 image has a peak video level of 100 IRE and the TVBar_75 image has a peak video level of 75 IRE.

The TVBar100 image is shown below.

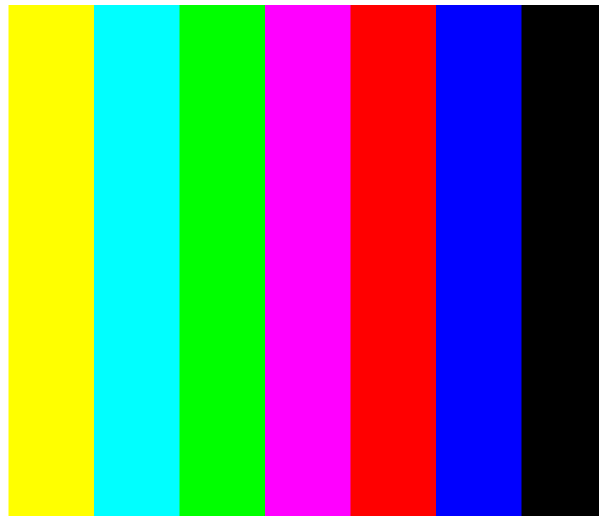

Test Color video performance

Purpose This general purpose pattern can be used to check the video handling capabilities of most parts of a television system.

Method When viewed on a TV screen, all of the colors should be correct and in the order shown. The hue and intensity of each bar should be uniform over the entire bar.

The image can be used with a TV waveform analyzer to check the performance of a video system. Individual scan lines of each image, as they would appear on a waveform analyzer, are shown on the following page.

The image is quite effective when used with a TV vectorscope to see how a video system handles an encoded color signal. The image consists of a white crosshatch on a black background. The lines form square boxes when the display's active video area has a 4:3 aspect ratio. The vertical lines are made using sine-squared ($2T$) pulses ($T = 125$ nSec for NTSC and $T = 100$ nSec for PAL).

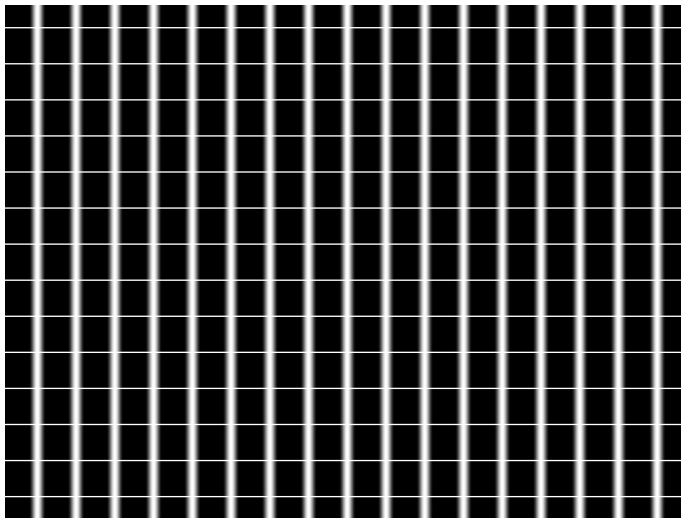

Test Convergence adjustment

Purpose To accurately produce an image on a color monitor, the three electron beams in the CRT must meet (converge) at the same location at the same time. Lines displayed on a mis-converged monitor will appear as several multi-colored lines, and the transitions between different colored areas will contain "fringes" of other colors.

Method The convergence adjustments of most color monitors can be divided into two main categories. The first set of adjustments, usually called "Static Convergence," calls for aligning the three beams in the center of the display. This method involves turning on all three guns and adjusting the various magnets on the convergence assembly to produce all white lines and dots in the center of the display. The convergence assembly is located on the neck of the CRT. Different monitors and CRT types may each require their own magnet adjustment sequence.

After the center of the display is properly converged, the outer areas can be adjusted by using the monitor's "Dynamic Convergence" controls. The number of controls, the area of the screen that they affect and their adjustment procedure is dependent upon the monitor under test.

Test Sweep linearity adjustment

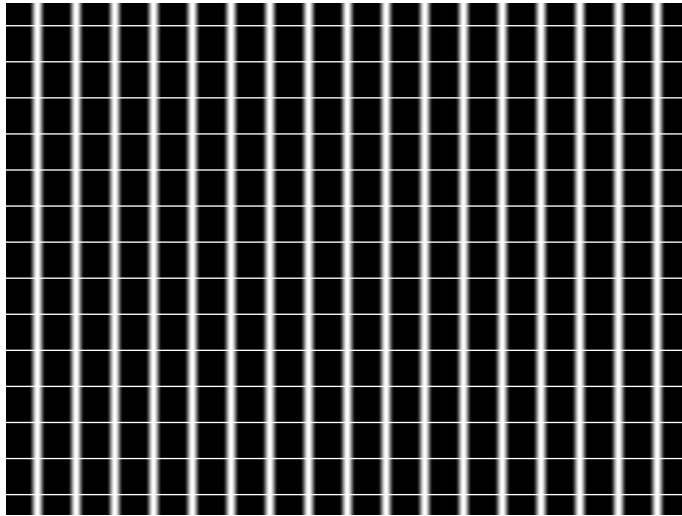

Purpose To present an undistorted display, the horizontal and vertical sweeps of the electron beam across the face of the CRT should be at uniform speeds. Any non-uniformity in the sweep will cause portions of an image to be stretched while other portions will be compressed. Non-linearity in a monitor can show up in several ways. It may be present across the entire screen, a large portion of the screen, or it may be localized in a very small area.

Method Adjust the display's linearity controls so that all of the boxes in the crosshatch are identical in size. You can measure the boxes with a ruler or with a gauge made for the monitor under test. Any deviation should be within your specification limits.

Taffeta

Description

TVoutLin

Description Equivalent to Outline1 image but it uses anti-aliasing for vertical bars and double horizontal lines, which reduces flickering.

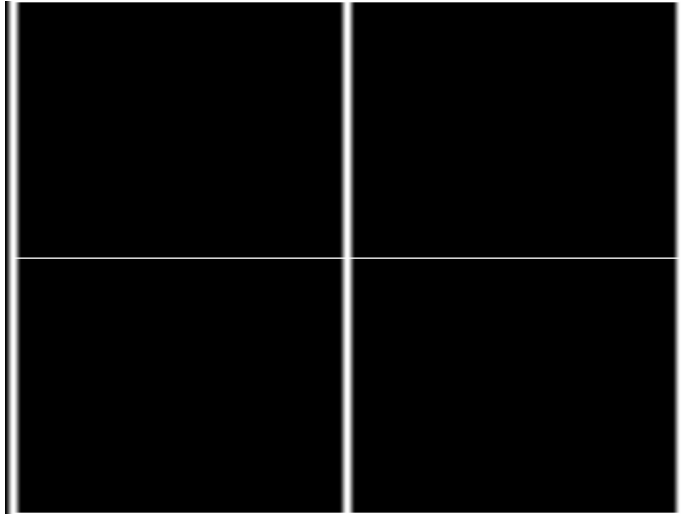

TVSplBar

Description Special test image developed per customer specifications.

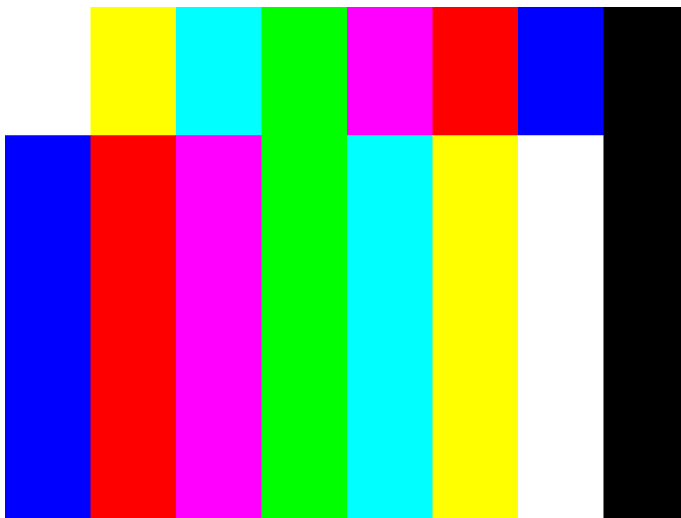

C Error Messages

Topics in this appendix:

- [Error code descriptions](#)

Error code descriptions

0000-0099 General errors

0001 No such command

The generator encountered an invalid command error condition.

0002 No such query

The generator encountered an invalid command query error condition.

0003 Too many arguments

The generator encountered too many arguments for the executed command.

0004 Invalid argument count

The generator encountered an invalid argument count for the executed command.

0005 Invalid argument value

The generator encountered an invalid argument value for the executed command.

0006 Invalid file

The generator encountered an invalid file error condition.

0007 Invalid file type

The generator encountered an invalid file type error condition.

0008 Invalid file data

The generator encountered an invalid file data error condition.

0099 Internal error

The generator encountered an internal error condition.

2000-2999 Format errors

2030 Number of fields per frame less than 1

A valid video format must have at least one (1) vertical field of video per frame.

2040 Number of fields per frame greater than 2

The generator hardware configuration does not support interlaced video formats having more than two (2) vertical fields per frame.

2041 Can not repeat field if progressive

Repeat field operation is only supported in interlaced video formats.

2050 Horizontal total too small

The video format's total (active + blanked) number of pixel clock cycles per horizontal scan line is below the minimum number supported by the generator hardware configuration.

2059 Invalid Mode

The video format setting is incompatible with the interface selected.

2060 Horizontal total too large

The video format's total (active + blanked) number of pixel clock cycles per horizontal scan line is greater than the maximum number supported by the generator hardware configuration.

2061 Invalid pixel repetition value

The value specified by the NPPP (number of pixels per pixel) to set the repetition factor for active lines is invalid.

2062 Invalid pixel and clock values

The value specified by the NCPP (number of clocks per pixel) to set the number of clocks per pixel is invalid.

2063 Invalid embedded aspect ratio

The value specified by the EXAR (extended aspect ratio) parameter is invalid.

2064 HDMI 5V pin is bad

The 5V pin of the HDMI connectors (Pin 18) is monitored by the generator. If the generator does not detect the 5V on this pin it will issue this error.

2065 Invalid specified border

The value specified for XLBW (left border width), XRBW (right border width), XTBH (top border height), or XBBH (bottom border height) is invalid.

2066 Invalid XAFD value

The value specified for the active format descriptor (XAFD) parameter was out of range.

2067 Invalid SXEX value

The value specified by the signal from extended aperture map is invalid.

2068 TMD5 5V pin is bad

The 5V pin of the DVI connectors is monitored by the generator. If the generator does not detect the 5V on this pin it will issue this error.

2071 Pixel rate too high

The video format's total (active + blanked) number of pixel clock cycles per horizontal scan line multiplied by the horizontal scan rate exceeds the maximum pixel clock frequency supported by the generator hardware configuration for the format's video type.

2072 Pixel clock rate too high for pixel depth

The video format's pixel depth combined with the total (active + blanked) number of pixel clock cycles per horizontal scan line and horizontal scan rate exceeds the maximum internal video data bit rate supported by the generator hardware configuration. The pixel depth and/or total number of pixels per line need to be reduced in order to keep the current horizontal scan rate.

2073 Pixel rate justification too high

The target pixel clock rate selected for justification of the video format exceeds the generator hardware configuration.

2074 Pixel depth not supported

The video format's pixel depth is not supported by the generator hardware configuration.

2075 Analog composite sync type not supported

The video format's analog video composite sync type selection is not supported by the generator hardware configuration.

2076 Digital sync composite type not supported

The video format's digital composite sync type selection is not supported by the generator hardware configuration.

2077 Number of digital links not allowed

The number of serial digital video data links in the video format exceeds the number of links supported by the current firmware.

2078 Digital sync separate type not allowed for HDTV formats

The generator hardware configuration does not support digital separate sync for the specific video type selection in the video format

2079 Number of links not supported

The number of serial digital video data links in the video format exceeds the number of links supported by the generator hardware configuration.

2080 Pixel rate too low

The video format's total (active + blanked) number of pixel clock cycles per horizontal scan line multiplied by the horizontal scan rate is less than the minimum pixel clock frequency supported by the generator hardware configuration for the format video type.

2082 Number of bits not allowed

The generator hardware configuration does not support the number of data bits per color for the serial digital video type selected in the video format.

2083 Invalid quantizing mode

An invalid value has been specified for the digital video quantizing mode (DVQM) parameter.

2084 Invalid Pixel Repetition

In digital mode, double clocking is not supported for this specific hardware. This error may be the result of an older FPGA or hardware.

2085 Invalid Sampling Mode

The value specified for digital video sampling mode (DVSM) is not valid and is inconsistent with the setting of digital video signal type (DVST).

2086 Invalid Video ID Code

The value specified for the CEA-861 Video Identification Code (VIC) with the DVIC parameter is invalid.

2087 Invalid Number of Bits per Audio Sample

The value specified for number of bits per audio sample (NBPA) is invalid.

2088 Invalid Sampling Rate

The value specified for audio sampling rate (ARAT) is invalid.

2089 Invalid Number of Audio Streams

The value specified for number of audio streams (NDAS) is invalid.

2090 Horizontal total not even

The generator hardware configuration does not support interlaced video formats with a total (active + blanked) number of pixel clock cycles per horizontal scan line that is not evenly divisible by 2.

-OR-

The generator hardware configuration does not support a video format with a total (active + blanked) number of pixel clock cycles per horizontal scan line that is not evenly divisible by 2 for the selected analog or digital composite sync type.

2091 Horizontal total not a multiple of 4

The generator hardware configuration does not support a video format with a total (active + blanked) number of pixel clock cycles per horizontal scan line that is not evenly divisible by 4. Mostly applies to video formats using serial digital video.

2092 Horizontal resolution not even

Number of active pixels per line must be evenly divisible by 2 for the given video format type and generator hardware configuration.

2093 Horizontal sync pulse width not even

Number of pixel clock cycles in the horizontal sync pulse width must be evenly divisible by 2 for the given video format type and generator hardware configuration.

2094 Horizontal sync pulse delay not even

The number of pixel clock cycles in the horizontal sync pulse delay must be evenly divisible by 2 for the given video format type and generator hardware configuration.

2096 Horizontal resolution not a multiple of 4

The generator hardware configuration does not support a video format with a number of active pixels per horizontal scan line that is not evenly divisible by 4. Mostly applies to video formats using serial digital video.

2097 Horizontal sync pulse width not a multiple of 4

The generator hardware configuration does not support a video format with the number of pixel clock cycles in the horizontal sync pulse width not evenly divisible by 4. Mostly applies to video formats using serial digital video.

2098 Horizontal sync pulse delay not a multiple of 4

The generator hardware configuration does not support a video format with the number of pixel clock cycles in the horizontal sync pulse delay not evenly divisible by 4. Mostly applies to video formats using serial digital video.

2099 JRAT greater than 200MHz not allowed

The 802BT generator does not support a setting of JRAT greater than 200MHz.

2110 Invalid number of audio channels

The value specified for the number of digital audio channels is out of range.

2111 Invalid digital audio signal type

The value specified for digital audio signal type (DAST) is out of range.

2112 Invalid audio digital signal interface

The value specified for digital audio signal interface (DASI) is out of range.

2113 Invalid number of audio channels available

2114 Invalid audio level shift value

The value specified for digital audio level shift (DALC) is out of range.

2115 Invalid audio sine wave rate

The value specified for digital audio sine wave rate (SRAT) is out of range.

2117 Fs measured is not equal to Fs assigned

The value detected for the sampling frequency is not equal to the value assigned for the audio sampling rate (ARAT). This typically means there is a hardware problem in the generator's digital audio generator.

2118 Invalid audio signal amplitude

The value specified by digital audio sine wave amplitude (SAMP) is out of range.

2119 Send CP info error is not zero

The CP infoframe register on the transmitter is not set to zero and the infoframe is not transmitted. This typically means that there is a hardware problem in the HDMI board.

2120 Send AVI info error is not zero

The AVI infoframe register on the transmitter is not set to zero and the infoframe is not transmitted. This typically means that there is a hardware problem in the HDMI board.

2121 Send SPD info error is not zero

The SPD infoframe register on the transmitter is not set to zero and the infoframe is not transmitted. This typically means that there is a hardware problem in the HDMI board.

2122 Send AUD info error is not zero

The AUD infoframe register on the transmitter is not set to zero and the infoframe is not transmitted. This typically means that there is a hardware problem in the HDMI board.

2123 Send MPEG info error is not zero

The MPEG infoframe register on the transmitter is not set to zero and the infoframe is not transmitted. This typically means that there is a hardware problem in the HDMI board.

2124 Send GEN info error is not zero

The General infoframe register on the transmitter is not set to zero and the infoframe is not transmitted. This typically means that there is a hardware problem in the HDMI board.

2125 Invalid sonic data

The value specified for the digital audio mixer (SDMG) is out of range.

2126 Invalid content aspect ratio

The value specified by the CXAR (content aspect ratio) parameter is invalid.

2128 Invalid audio contents

2129 Invalid signal aspect ratio

The value specified by the SXAR (signal aspect ratio) parameter is invalid.

2130 Horizontal active too small

The number of active pixels per horizontal scan line is less than the minimum supported by the generator hardware configuration.

2140 Horizontal blanking too small

The video format's horizontal blanking period expressed in microseconds and/or number of pixel clock cycles is not supported by the generator hardware configuration.

2141 Horizontal blanking too small

Same as Error number 2140. Found in some firmware releases for different generator hardware configurations.

2150 Horizontal blanking too small

Same as Error number 2140. Found in some firmware releases for different generator hardware configurations.

2151 Horizontal total less than horizontal resolution

The video format's total (active + blanked) number of pixel clock cycles per horizontal scan line can not be less than the number of active pixels per scan line.

2152 Horizontal resolution too large or Horizontal blanking too small

Same as Error number 2140. Found in some firmware releases for different generator hardware configurations.

2155 Horizontal blanking too small

Same as Error number 2140. Found in some firmware releases for different generator hardware configurations.

2180 Horizontal pulse width too small

The generator hardware configuration does not support video formats having horizontal sync pulse widths less than one pixel clock cycle long.

2181 Horizontal sync pulse width not even

Number of pixel clock cycles in the horizontal sync pulse width must be evenly divisible by 2 at the current pixel clock rate for the video format and generator hardware configuration.

2190 HSPW too small for HDTV sync

The generator hardware configuration does not support video formats having horizontal sync pulse widths less than two pixel clock cycles long for the current video and HDTV sync type selections.

2191 HSPW must be even for HDTV sync

The number of pixel clock cycles in the horizontal sync pulse width must be evenly divisible by 2 for the current video and HDTV sync type selections.

2200 Horizontal pulse width too large

The generator hardware configuration does not support a horizontal sync pulse width that is greater than the horizontal blanking period.

2201 Horizontal pulse delay not even.

The number of pixel clock cycles in the horizontal sync pulse delay must be evenly divisible by 2 at the current pixel clock rate for the video format and generator hardware configuration.

2205 Frame sync pulse width too small

The generator hardware configuration does not support a Frame Sync pulse width less than horizontal scan period.

2206 Frame sync pulse width too large

The Frame Sync pulse width can not be greater than the total (active + blanked) number of horizontal scan lines in one frame of video.

2207 Probe sync pulse width too small

The probe sync pulse width is less than minimum supported by the generator hardware configuration.

2208 Probe sync pulse width too large

The probe sync pulse width is greater than maximum supported by the generator hardware configuration.

2230 Horizontal pulse delay extends sync beyond blanking

The generator hardware configuration does not support the video format's combination of horizontal sync pulse delay and pulse width that places any portion of the horizontal sync pulse outside of the horizontal blanking period.

2231 Vertical serration adjustment too big

The video format's HVSA setting beyond the maximum limit for the video type selected and generator hardware configuration.

2240 Vertical total too small

The total (active + Blanked) number of horizontal scan lines per frame a progressive scan (non-interlaced) video format is less than the minimum supported by the generator hardware configuration.

2250 Vertical total too small for interlaced format

The total (active + blanked) number of horizontal scan lines per frame is less than the minimum number supported by the generator hardware configuration.

2270 Vertical total is even

The generator hardware configuration does not support interlaced scan video formats having an even total (active + blanked) number of horizontal scan lines per frame.

2280 Vertical total too large

The total (active + blanked) number of horizontal scan lines per frame exceeds the maximum limit for the generator hardware configuration.

2300 Vertical active too small

The active number of horizontal scan lines per frame of a progressive scan (non-interlaced) video format is less than the minimum supported by the generator hardware configuration.

2310 Vertical blanking too small

The number of blanked horizontal scan lines per frame for a progressive scan (non-interlaced) video format is less than the minimum supported by the generator hardware configuration.

2320 Vertical active too small for interlaced format

The active number of horizontal scan lines per frame of an interlaced video format is less than the minimum supported by the generator hardware configuration.

2321 Vertical active not even

The generator hardware configuration does not support interlaced scan video formats having an odd active number of horizontal scan lines per frame.

2330 Vertical blanking too small for interlaced format

The number of blanked horizontal scan lines per frame for an -interlaced video format is less than the minimum supported by the generator hardware configuration.

2350 Vertical pulse too small

The vertical sync pulse width is less than the minimum supported by the generator hardware configuration.

2370 Vertical pulse too large

The vertical sync pulse width is greater than the maximum supported by the generator hardware configuration.

2390 Vertical pulse too large for interlaced format

The vertical sync pulse width combined with the number of pre and post-equalization pulses for an interlaced format is greater than the maximum supported by the generator hardware configuration.

2391 Incompatible analog composite sync & digital composite sync types

The generator hardware configuration does not support the video format outputting both analog composite sync and digital composite sync type selections at the same time.

2392 Incompatible analog composite sync & digital separate sync types

The generator hardware configuration does not support the video format outputting both analog composite sync and digital separate sync type selections at the same time.

2393 Analog composite sync type not compatible with analog video type

The generator hardware configuration does not support the video format's analog composite sync type being added to the current analog video type.

2394 ACS available on green only

The generator hardware configuration supports adding analog composite sync to only the green analog video output

2395 Sync type selection incompatible with analog video type selection

The video format's analog video type selection requires the use of analog composite sync.

2396 Invalid analog composite sync type

The current firmware does not support the format's analog composite sync type parameter value (ASCT setting) or the generator hardware configuration does not support a video format's analog composite sync type for non-interlaced operation.

2397 Invalid digital composite sync type

The current firmware does not support the format's digital composite sync type parameter value (DSCT setting) or the generator hardware configuration does not support a video format's digital composite sync type for non-interlaced operation.

2398 Invalid digital separate sync type

The current firmware or generator hardware configuration does not support the format's digital separate sync type parameter value (DSST setting)

2399 Invalid sync type selection

The current firmware does not support the format's active sync type selection (SSST setting).

2400 Analog composite sync type and digital separate sync type incompatible

The generator hardware configuration does not support analog composite sync and digital separate sync being active at the same time for the given analog composite sync type parameter value (ASCT setting) and digital separate sync type parameter value (DSST setting).

2401 Invalid horizontal sync pulse delay

The generator hardware configuration does not support the format's current horizontal sync pulse delay setting

2405 Frame sync pulse delay negative

The video format's frame sync pulse delay setting must be zero or a positive number.

2406 Frame sync pulse delay too large

The video format's frame sync pulse delay setting exceeds the maximum limit supported by the generator hardware configuration.

2407 Negative probe sync pulse vertical delay

The video format's probe pulse vertical delay setting must be zero or a positive number.

2408 Probe sync pulse vertical delay too large

The video format's probe pulse vertical delay setting exceeds the maximum limit supported by the generator hardware configuration.

- 2409 Negative probe sync pulse horizontal delay**
The video format's probe pulse horizontal delay setting must be zero or a positive number.
- 2410 Probe sync pulse horizontal delay too large**
The video format's probe pulse horizontal delay setting exceeds the maximum limit supported by the generator hardware configuration.
- 2425 Sync type selection not supported**
The current firmware does not support the video format's active sync type selection (SSST setting) or the active sync type selection is not supported by the current analog video type selection (AVST setting).
- 2430 Vertical pulse delay extends sync beyond blanking**
The generator hardware configuration does not support non-interlaced video formats having a vertical sync pulse period greater than the vertical blanking period.
- 2450 Vertical pulse delay extends sync beyond blanking**
The generator hardware configuration does not support interlaced video formats having a vertical sync pulse period greater than the individual blanking periods between the fields.
- 2465 Pixel clock pulse gate = 1 and pixel depth = 8**
The generator hardware configuration does not support outputting a pixel clock output when the video format's pixel depth is eight bits-per-pixel.
- 2466 Pixel clock pulse gate = 1 not allowed**
The generator hardware configuration does not support a pixel clock output.
- 2490 EQ before too large**
The video format's number of lines of pre-equalization for analog or digital composite sync must not exceed the number of lines of vertical sync pulse delay.
- 2495 EQ after too large for interlaced format**
The interlaced video format's number of lines of post-equalization for analog or digital composite sync must not exceed the number of scan lines from the end of the vertical sync pulse to the start of video for either field.
- 2496 EQ after too large**
The non-interlaced video format's number of lines of post-equalization for analog or digital composite sync must not exceed the number of scan lines from the end of the vertical sync pulse to the start of video.

2550 Not enough video memory

The generator hardware configuration does not have enough video memory to support the video format's combination of active pixels per line (HRES setting) and active lines per frame (VRES setting).

2551 Insufficient memory

Not implemented at the time this document was created.

2553 No PCMCIA card found in drive

When attempting to download a bitmap no PCMCIA card was detected in the generator's PCM slot.

2554 PCMCIA card is write-protected

When attempting to download a bitmap to a PCMCIA card, the PCM card was write-protected.

2555 PCMCIA card is bad

When attempting to download a bitmap to a PCMCIA card, the PCM card was found to be bad.

2704 Invalid horizontal physical size

The video format's horizontal physical size value can not be negative.

2705 Invalid physical size units

The current firmware does not support the type number used for the video format's units of measure for physical size (USIZ setting).

2706 Invalid vertical physical size

The video format's vertical physical size value can not be negative.

2714 Pedestal swing out of range

The video format's blanking pedestal level (AVPS setting) can not be less than 0.0% of the peak video level or more than 100.0% of the peak video level.

2715 Gamma correction out of range

The current firmware does not support a video format's gamma correction factor (GAMA setting) of less than 0.1 or greater than 10.

2716 Analog video swing out of range

The generator hardware configuration does not support the video format's analog video swing value (AVSS setting) for the given analog video type selection.

2717 Sync swing out of range

The generator hardware configuration does not support the video format's analog video composite sync swing value (ASSS setting) for the given analog video type selection.

2719 Video swing calibration out of range

The generator hardware configuration does not support the current user defined analog video swing calibration factors (AVSC settings) for one or more of the red, green or blue channels. The valid factory default setting is 1.00 for all three channels.

2720 Sync swing calibration out of range

The generator hardware configuration does not support the current user defined analog video composite sync swing calibration factors (ASSC settings) for one or more of the red, green or blue channels. The valid factory default setting is 1.00 for all three channels.

2721 NTSC TV signals require blanking pedestal

The generator hardware configuration does not support producing NTSC TV video outputs that do not use a blanking pedestal (AVPG setting of 0) as required by the NTSC specifications.

2722 Blanking pedestal out of range for NTSC TV signal

The generator hardware configuration does not support producing NTSC TV video outputs that do not use a nominal blanking pedestal level (AVPS setting) of 7.5 IRE as required by the NTSC specifications.

2741 Digital video signal type not supported

The generator hardware configuration does not support any type of digital video outputs.

2742 Invalid digital video signal type

The current firmware does not support the format's digital video type selection (DVST setting).

2743 Digital video polarity not positive

The generator hardware configuration and/or the firmware does not support digital video formats having a logic low level for the active (lit) pixels.

2745 Can not have analog AND digital video

The generator hardware configuration does not support the simultaneous generation of analog and digital video signals.

2747 Invalid analog video signal type

The current firmware for a given model generator does not support the video format's analog video type selection.

- 2748 Analog video signal type not supported**
The generator hardware configuration does not support the video format's analog video type selection.
- 2760 Digital video not supported**
The generator hardware configuration does not support the video format's digital video type selection.
- 2761 Digital video signal swing out of range**
The value specified for the digital video signal swing is out of range.
- 2762 Digital video swing calibration out of range**
The value specified for the digital video swing calibration is out of range.
- 2763 Invalid XVSI**
The value specified for the interface selection (XVSI) is invalid.
- 2800 Pseudo-random noise seed value exceeds limit**
The seed value for the pseudo-random noise analysis exceeds its maximum value.
- 2801 Pseudo-random noise sequence exceeds limit**
The length of the pseudo-random noise sequence exceeds maximum value.
- 2802 Pseudo-random noise type is not supported**
The pseudo-random noise type is not supported.
- 2803 No signal input to analyzer or TMDs error**
There is no signal input to the receive interface of the analyzer.
- 2804 X coordinate for delta patch out-of-range**
The value specified for the X coordinate of the delta patch test is out-of-range.
- 2805 Y coordinate for delta patch out-of-range**
The value specified for the Y coordinate of the delta patch test is out-of-range.
- 2806 Patch height must be greater than one**
The patch height specified for a delta error test must be greater than one.

3000-3999 Image errors

3000 Invalid color name

The current firmware does not support a named color used by one or more primitives in the user defined custom image

3001 Invalid pattern name

The current firmware does not support a named fill patterns used by one or more primitives in the user defined custom image

3002 No image memory

There is not enough unused edit buffer memory space available to start a new custom image editing session.

3004 Invalid font name

The current firmware does not support a named font used by one or more primitives in the user defined custom image

3005 Image editor running

The current firmware does not allow a new custom image editing session to be started while the current custom image editing session is still running.

3006 Nothing to save

An attempt was made to save the contents of a custom image editing buffer when there was no open custom image editing session to save.

3007 Overwrite ROM Image

A user defined test image can not be saved using the same name as that of a built-in test image (case insensitive).

3008 Image save failed

Saving the contents of the custom image editing buffer failed for a reason other than those reported by error codes 3005 or 3006.

3010 R, G or B 8-Bit video DAC setting out of range

A combination of system calibration factors, user calibration multiplier settings and video output level settings have resulted in one or more calculated input values to go below zero or above the analog video Digital-to-Analog Converter's maximum limit of 255.

3011 R, G or B 6-Bit video DAC setting out of range

A combination of system calibration factors, user calibration multiplier settings and video output level settings have resulted in one or more calculated input values to go below zero or above the analog video Digital-to-Analog Converter's maximum limit of 63.

3015 R, G or B 10-Bit video DAC setting out of range

A combination of system calibration factors, user calibration multiplier settings and video output level settings have resulted in one or more calculated input values to go below zero or above the analog video Digital-to-Analog Converter's maximum limit of 1023.

3020 Kill EPROM image

Built in test images can not be removed from the firmware.

3025 Image not found

A test image of a given name could not be found as either a built-in test image in the firmware or as a user defined custom image.

3050 Grayscale video DAC setting out of range

One or more internal calculations have resulted in an analog video DAC input grayscale setting below zero or greater than 100% video level.

4000-4999 Test sequence errors

4000 Invalid format name

The test sequence contains one or more steps that have an invalid format name parameter.

4001 Invalid image name

The test sequence contains one or more steps that have an invalid image name parameter.

4002 No sequence memory

There is not enough unused edit buffer memory space available to start a new test sequence editing session.

4003 Sequence memory full

There is not enough free battery backed user storage memory to save the sequence that is in the edit buffer.

4004 Sequence not found

A test sequence of the given name could not be found in the user storage memory area.

4005 Sequence editor running

The current firmware does not allow a new test sequence editing session to be started while the current test sequence editing session is still running.

4006 No sequence to save

An attempt was made to save the contents of a test sequence editing buffer when there was no open test sequence editing session to save.

4007 Sequence buffer full

No more steps can be added to the current sequence being edited because no more edit buffer space is available.

4008 Invalid delay setting in sequence

The test sequence contains one or more steps that have a negative number for the step delay time.

4010 Font index out of range

An attempt was made to use a font at an index location that is less than zero (0) or greater than the highest index number in use.

4020 No font present at given index

Attempt to access a font at a valid index but the specified index is empty because of a previous delete.

4030 Invalid font location

Can not install a font that has not first been transferred to memory.

4040 Sequence is running

A sequence editing session can not be started while a sequence is running.

4045 No sequence buffer

An attempt was made to change a parameter in a sequence step when there were no sequence steps in the current sequence being edited.

4100 Pattern index out of range

The selected index number for a drawing primitive's fill pattern is less than zero or greater than the highest number used by the current firmware.

4576 Can not convert to inches, not valid units

The format's current physical units of measure (inches or millimeters) is unknown and the firmware is unable to convert a dimension to inches.

4579 Can not convert to mm, not valid units

The format's current physical units of measure (inches or millimeters) is unknown and the firmware is unable to convert a dimension to millimeters.

5000-5999 Directory errors

5002 No directory memory

The DIRN or NAMI command failed because there is an insufficient amount of managed memory for the buffer request.

5003 Directory memory full

The DIRA or DIRS command failed because there is insufficient room in the directory memory pool for the requested save.

5006 No directory to save

An attempt was made to save the contents of a directory editing buffer when there was no open directory editing session to save.

5009 Directory list full

This occurs during DIRA and DIRS commands when attempting to save more directories than supported by the current firmware.

5010 Invalid name index

The value of the <index> parameter used for a NAMQ? query is can not be zero(0).

6000-6999 Bitmap errors

6006 No map to save

An attempt was made to save the contents of a bit map editing buffer when there was no open bit map editing session to save.

6020 Map not found

An attempt was made to access a bit map whose name can not be found in the generator's list of currently stored bitmaps

6030 Invalid map dimensions

A bit map can not have a horizontal or vertical dimension of less than one (1) pixel.

6035 Invalid map depth

The current firmware and/or generator hardware configuration does not support pixel depth setting of the selected bit map.

6036 Map data index

An attempt was made to recall a bit map at an index location that is less than zero (0) or greater than the highest index number in use for bit maps.

7000-7999 LUT errors

7006 No LUT to save

An attempt was made to save the contents of a color lookup table editing buffer when there was no open color lookup table editing session to save.

7010 No LUT buffer

An attempt was made to modify the contents of a color lookup table editing buffer when there was no open color lookup table buffer available.

7011 Invalid LUT Index

An attempt was made to recall a color lookup table at an index location that is less than zero (0) or greater than the highest index number in use for color lookup tables.

7020 LUT not found

8000-8999 Font errors

8450 Cannot remove font. Font not found.

Attempt to use FNTK command to delete a nonexistent font by name.

8455 Cannot remove built-in font

Attempt to use FNTK command to delete a built-in font.

8460 Font already exists in memory

Attempt made to transmit a font to the generator which already contained a font with the same name.

9000-9999 System errors

9450 Corrupted format

Checksum error in data for a particular video format

9451 Bad location for format, failed verify

This occurs during FMTV command and FMTV? query when you attempt to verify data integrity at an invalid location.

9452 Bad location for format verify

This occurs during a FMTZ? query when you try to determine if an invalid location has been erased.

9453 Kill EPROM format

Cannot delete factory default formats stored in EPROM

9453 Can not change EPROM contents

This occurs during FMTW or FMTZ commands when you try to overwrite or zero out an EPROM format.

9454 Bad location for format erase

This occurs during FMTE command when you try to access an invalid format memory location.

9456 Bad location for format read/write

This occurs during FMTR or FMTW commands when you try to read or write to an invalid format memory location.

9457 Bad location for format name read

This occurs during FMTR? query when you try to read or write to an invalid format memory location.

9458 Bad location for format copy

This occurs during FMTD command when you try during copying to access an invalid format memory location.

9459 Can not change EPROM contents

This occurs during FMTD command when you try during copying to overwrite an EPROM format.

9460 Bad location for format duplicate

This occurs during FMTD and FMTI commands when you try to use one or more invalid format memory locations as the command arguments.

9467 Bad location for format erase

This occurs during FMTZ command when you try to make one or more invalid format memory locations as the command arguments.

9470 Can not change EPROM contents

An attempt was made to insert a format using the FMTI command into an EPROM format memory location.

9471 Bad location for format yank

This occurs when you try to remove (yank) one or more formats from invalid format memory locations using the FMTY command.

9472 Can not change EPROM contents

This occurs when you try to remove (yank) one or more formats from EPROM format memory locations using the FMTY command.

9475 Can not change EPROM contents

One or more EPROM format locations was given as the destination location for the FMTD command.

9477 Error duplicating formats

The <first> memory location parameter used with the FMTD command is greater than the <last> memory location parameter.

9480 Format not found / Format data missing

The FMTR command tried to read a format from an empty format storage location.

9490 DDC mod not present

The generator hardware configuration does not support DDC communications.

9491 DDC not available

The generator hardware configuration does not support DDC communications.

9492 DDC2B no ACK from receiver

Low level DDC communications failed with Unit Under Test (UUT). No DDC acknowledgment bit was received from the UUT.

9493 DDC2B arbitration lost

Low level DDC communications failed with Unit Under Test (UUT). DDC bus arbitration lost with the UUT.

9494 DDC2B timeout on bus

Low level DDC communications failed with Unit Under Test (UUT). DDC communications timed out with the UUT.

9496 EDID header not found

A valid block of header data could not be found in the EDID data read back from Unit Under Test (UUT).

9497 DDC old monitor

A DDC compliant Unit Under Test (UUT) could not be found connected to the generator.

9498 I2C address missing

There was a communications error within the generator hardware architecture because the device address was missing.

9499 I2C count missing

There was a communications error within the generator hardware architecture because the data count was missing.

9500 I2C stream too big

There was a communications error within the generator hardware architecture because the data stream size exceeded the size supported by the device.

9501 I2C data missing

There was a communications error within the generator hardware architecture because the device data stream was missing.

9502 I2C register missing

There was a communications error within the generator hardware architecture.

9503 I2C data byte missing

There was a communications error within the generator hardware architecture because the device data stream had missing data.

9504 Serial digital video PLL not locked

There is an internal problem with the generator's serial digital video hardware's Phase Lock Loop circuit.

- 9505 TV output hardware not ready**
The generator's serial digital video generating hardware is not yet ready to output video
- 9506 Serial digital video hardware not ready**
The generator's TV signal generating hardware reports it is not yet ready to output valid video
- 9507 I2C offset missing**
There was a communications error within the generator hardware architecture
- 9508 Invalid HDCP receiver KSV**
The HDCP Key Selection Vector returned from the HDCP receiver in the Unit Under Test (UUT) is not valid.
- 9520 HDCP key combination not supported**
The HDCP key combination between the Tx and the Rx is invalid. The Tx may have production keys and the Rx public keys.
- 9521 HDCP failed after a while**
The HDCP authentication started but failed after a while.
- 9522 HDCP key combination not supported**
The HDCP authentication did not start.
- 9523 HDCP production keys not supported**
HDCP test initiated and specified production keys where are not supported in generator option.
- 9524 Invalid transmitter KSV**
HDCP video transmitter KSV sent by the generator is invalid.
- 9525 HDCP Ri value not ready**
HDCP authentication cannot start because HDCP Ri value (link verification response) at the transmitter is not ready.
- 9527 HDCP Ri do not match**
HDCP authentication cannot start because HDCP Ri (link verification response) values at the transmitter and receiver do not match.
- 9528 HDCP was interrupted**
HDCP authentication was interrupted possibly by disconnecting the cable.

- 9529 HDCP receiver not detected**
HDCP authentication failed to start because the hot plug was not detected.
- 9530 HDCP invalid for animation**
HDCP test will not run when an animated image is loaded.
- 9531 I2C segment number missing**
The segment number of the enhanced DDC bus is missing.
- 9532 I2C address 1 missing**
The first address of the enhanced DDC bus is missing.
- 9533 I2C address 2 missing**
The second address of the enhanced DDC bus is missing.
- 9538 Memory address out of range**
The generator encountered a memory address out of range condition.
- 9539 Memory count missing**
The generator encountered a memory count missing condition.
- 9540 Memory stream too big**
The generator encountered a memory stream too big condition.
- 9541 Memory data missing**
The generator encountered a memory data missing condition.
- 9542 Memory address missing**
The generator encountered a memory address missing condition.
- 9544 Repeater not ready**
The generator encountered a repeater not ready condition.
- 9545 Repeater mismatch**
The generator encountered a repeater mismatch condition.
- 9546 FIFO not ready**
The generator encountered a FIFO not ready condition.

9600 Can not save format to EPROM

An attempt was made to save a format edit buffer's contents to a location in the firmware EPROM.

10000-10999 System errors

10000 Out of memory

There is not enough unused battery backed user memory space to store the contents of the given edit buffer

10010 Invalid file check sum

The data object file that has been recalled from the generator's memory contains an invalid checksum. Data may be corrupted.

10020 Invalid file version

The data object file that has been recalled from memory contains a file version number that does not match the current firmware. Data may not be properly interpreted by the firmware

10025 File type

The data object file that has been recalled from memory contains a file type identification that is not supported by the current firmware.

10026 File size

The size of the data object file that has been recalled from memory does not match the size information stored in the file's header data.

10030 Feature not implemented

The generator hardware configuration does not support one or more settings in the video format.

10031 Feature not available

The generator hardware configuration does not support the selected feature.

10035 Video board not detected

An attempt was made to reprogram the firmware Flash EPROMs in a Model 822 series generator without a video board installed. The video board's memory is used as a buffer for the initial uploading of the firmware data.

10040 Buffer overflow

The generator encountered a buffer overflow condition.

10100 Filename alias not found

An attempt was made to delete a filename alias that does not exist.

10200 Font not overwriteable

An attempt was made to save the contents of a font editing buffer to a location in the firmware EPROM.

10205 Font save failed

There is not enough unused battery backed user memory space to store the contents of the font editing buffer.

10210 Font table range

The recalled font data object contains a reference to a nonexistent table in the data object.

10215 Font table Index range

The recalled font data object contains a reference to a nonexistent location in one of the tables in the data object.

10220 Font not found

An attempt was made to recall a font by name that is not stored in the generator.

10225 Can not delete font in EPROM

An attempt was made to delete a font stored in the firmware EPROM.

10230 Invalid font check mode

The current firmware does not support the selected test method on the contents of the font edit buffer.

10235 No font definition

The recalled font does not contain valid font definition data need to determine the size needed by the edit buffer.

10240 Font character high range

The character height setting of the font in the edit buffer is less than one or greater than the maximum supported by the current firmware.

10241 Font ascent descent sum

The character height setting of the font in the edit buffer is does not match the sum of the character ascent and descent settings

10242 Invalid font character range

The first or last character number setting of the font in the edit buffer is greater than the maximum supported by the current firmware or the number of the first character is greater than the number of the first character.

10300 CEC receive bit error

The generator encountered a CEC receive bit error condition.

10301 CEC receive time error

The generator encountered a CEC receive time error condition.

10302 CEC receive FIFO error

The generator encountered a CEC receive FIFO error condition.

10303 CEC receive start error

The generator encountered a CEC receive start error condition.

10304 CEC receive drop error

The generator encountered a CEC receive drop error condition.

10305 CEC receive free error

The generator encountered a CEC receive free error condition.

10310 CEC transmit line error

The generator encountered a CEC transmit line error condition.

10311 CEC transmit arb lost

The generator encountered a CEC transmit arb lost error condition.

10312 No acknowledgement from receiver

Upon sending a CEC message from the command line, the target CEC device does not acknowledge the message.

10313 CEC transmit failed

The generator encountered a CEC transmit failed condition.

10320 CEC message error

The generator encountered a CEC message error condition.

D Format Reference

Topics in this appendix:

- Formats by type

SDTV Formats

Format	Active (HxV)	Scan	Horizontal Rate (kHz)	Vertical Rate (Hz)	Pixel Rate (MHz)
480i	720 x 480	Interlace	15.734	59.940	13.500
480i#	720 x 480	Interlace	15.734	59.940	12.272727
480i#KA	720 x 480	Interlace	15.734	59.940	12.272727
480i2x_1	720 x 480	Interlace	62.937	239.760	53.999968
480i2x_2	720 x 480	Interlace	63.000	240.000	54.054
480i2x29	720 x 480	Interlace	15.734	59.940	13.500
480i2x30	720 x 480	Interlace	15.750	60.000	13.5135
480i2x59	720 x 480	Interlace	31.469	119.880	27.000
480i2x60	720 x 480	Interlace	31.500	120.000	27.027
480i2xL1	720 x 480	Interlace	15.734	59.940	13.500
480i2xL2	720 x 480	Interlace	15.750	60.000	13.5135
480i2xL3	720 x 480	Interlace	31.469	119.880	26.999984
480i2xL4	720 x 480	Interlace	31.500	120.000	27.027
480i2xL5	720 x 480	Interlace	62.937	239.760	53.999968
480i2xL6	720 x 480	Interlace	63.000	240.000	54.054
480i2xS1	720 x 480	Interlace	15.734	59.940	13.500
480i2xS2	720 x 480	Interlace	15.750	60.000	13.513500
480i2xS3	720 x 480	Interlace	31.469	119.880	26.999984
480i2xS4	720 x 480	Interlace	31.500	120.000	27.027
480i2xS5	720 x 480	Interlace	62.937	239.760	53.999968
480i2xS6	720 x 480	Interlace	63.000	240.000	54.054
480i4x29	2880 x 480	Interlace	15.734	59.940	54.000
480i4x30	2880 x 480	Interlace	15.750	60.000	54.054
480i4xL1	2880 x 480	Interlace	15.734	59.940	54.000
480i4xL2	2880 x 480	Interlace	15.750	60.000	54.054
480i4xS1	2880 x 480	Interlace	15.734	59.940	54.000
480i4xS2	2880 x 480	Interlace	15.750	60.000	54.054
480iLH	720 x 480	Interlace	15.734	59.940	13.500
480iSH	720 x 480	Interlace	15.734	59.940	13.500
480iWH	960 x 480	Interlace	15.734	59.940	18.000

Format	Active (HxV)	Scan	Horizontal Rate (kHz)	Vertical Rate (Hz)	Pixel Rate (MHz)
480p#	640 x 480	Interlace	31.469	59.940	24.545454
480p#KA	640 x 480	Progressive	31.469	59.940	24.545454
480p119	720 x 480	Progressive	62.937	119.880	54.000
480p119L	720 x 480	Progressive	62.937	119.880	54.000
480p119S	720 x 480	Progressive	62.937	119.880	54.000
480p120	720 x 480	Progressive	63.000	120.000	54.054
480p120L	720 x 480	Progressive	63.000	120.000	54.054
480p120S	720 x 480	Progressive	63.000	120.000	54.054
480p239	720 x 480	Progressive	125.874	239.760	107.999992
480p239L	720 x 480	Progressive	125.874	239.760	107.999992
480p239S	720 x 480	Progressive	125.874	239.760	107.999992
480p240	720 x 480	Progressive	126.000	240.000	108.108
480p240L	720 x 480	Progressive	126.000	240.000	108.108
480p240S	720 x 480	Progressive	126.000	240.000	108.108
480p2x59	1440 x 480	Progressive	31.469	59.940	54.000
480p2x60	1440 x 480	Progressive	31.500	60.000	54.054
480p2xL1	1440 x 480	Progressive	31.469	59.940	54.000
480p2xL2	1440 x 480	Progressive	31.500	60.000	54.054
480p2xS1	1440 x 480	Progressive	31.469	59.940	54.000
480p2xS2	1440 x 480	Progressive	31.500	60.000	54.054
480p4x59	2880 x 480	Progressive	31.469	59.940	108.000
480p4x60	2880 x 480	Progressive	31.500	60.000	108.108
480p4xL1	2880 x 480	Progressive	31.469	59.940	108.000
480p4xL2	2880 x 480	Progressive	31.500	60.000	108.108
480p4xS1	2880 x 480	Progressive	31.469	59.940	108.000
480p4xS2	2880 x 480	Progressive	31.500	60.000	108.108
480p59	720 x 480	Progressive	31.469	59.940	27.000
480p59LH	720 x 480	Progressive	31.469	59.940	27.000
480p59SH	720 x 480	Progressive	31.469	59.940	27.000
480p60	720 x 480	Progressive	31.500	60.000	27.027
480p60LH	720 x 480	Progressive	31.500	60.000	27.027
480p60SH	720 x 480	Progressive	31.500	60.000	27.027
480pWH	960 x 480	Progressive	31.469	59.940	36.000
487i	720 x 487	Interlace	15.734	59.939	13.500
576i	720 x 576	Interlace	15.625	50.000	13.500
576i#	720 x 576	Interlace	15.625	50.000	14.750
576i#KA	720 x 576	Interlace	15.625	50.000	14.750
576i2x_1	720 x 576	Interlace	62.500	200.000	54.000
576i2x25	720 x 576	Interlace	16.625	50.000	13.500
576i2x50	720 x 576	Interlace	31.250	100.000	27.000
576i2xL1	720 x 576	Interlace	31.250	100.000	27.000
576i2xL2	720 x 576	Interlace	62.500	200.000	54.000
576i2xLH	720 x 576	Interlace	16.625	50.000	13.500
576i2xS1	720 x 576	Interlace	31.250	100.000	27.000
576i2xS2	720 x 576	Interlace	62.500	200.000	54.000
576i2xSH	720 x 576	Interlace	15.625	50.000	13.500
576i4x25	2880 x 576	Interlace	15.625	50.000	54.000

Format	Active (HxV)	Scan	Horizontal Rate (kHz)	Vertical Rate (Hz)	Pixel Rate (MHz)
576i4xLH	2880 x 576	Interlace	15.625	50.000	54.000
576i4xSH	2880 x 576	Interlace	15.625	50.000	54.000
576i50	720 x 576	Interlace	31.250	100.000	27.000
576i50_H	960 x 576	Interlace	31.250	100.000	37.125
576i50_L	960 x 576	Interlace	31.250	100.000	37.125
576i50WH	960 x 576	Interlace	31.250	100.000	36.000
576i50WL	960 x 576	Interlace	31.250	100.000	36.000
576iLH	720 x 576	Interlace	15.625	50.000	13.500
576iSH	720 x 576	Interlace	15.625	50.000	13.500
576iWH	960 x 576	Interlace	15.625	50.000	18.000
576p#	768 x 576	Progressive	31.250	50.000	29.500
576p100	720 x 576	Progressive	62.500	100.000	54.000
576p100L	720 x 576	Progressive	62.500	100.000	54.000
576p100S	720 x 576	Progressive	62.500	100.000	54.000
576p200	720 x 576	Progressive	125.000	200.000	108.000
576p200L	720 x 576	Progressive	125.000	200.000	108.000
576p200S	720 x 576	Progressive	125.000	200.000	108.000
576p2x50	1440 x 576	Progressive	31.250	50.000	54.000
576p2xLH	1440 x 576	Progressive	31.250	50.000	54.000
576p2xSH	1440 x 576	Progressive	31.250	50.000	54.000
576p4x50	2880 x 576	Progressive	31.250	50.000	108.000
576p4xLH	2880 x 576	Progressive	31.250	50.000	108.000
576p4xSH	2880 x 576	Progressive	31.250	50.000	108.000
576p50	720 x 576	Progressive	31.250	50.000	27.000
576p50LH	720 x 576	Progressive	31.250	50.000	27.000
576p50SH	720 x 576	Progressive	31.250	50.000	27.000
576pWH	960 x 576	Progressive	31.250	50.000	36.000
576pWH_	960 x 576	Progressive	31.250	50.000	37.125
576pWL	960 x 576	Progressive	31.250	50.000	36.000
576pWL_	960 x 576	Progressive	31.250	50.000	37.125
Betacam	768 x 480	Interlace	15.734	59.940	14.318
NTSC#KA	640 x 480	Interface	15.734	59.940	12.273
NTSC#	640 x 480	Interface	15.734	59.940	12.273
NTSC	710x 480	Interface	15.734	59.940	13.500
NTSC-LH	720 x 480	Interface	15.734	59.940	13.500
NTSC-SH	720 x 480	Interface	15.734	59.940	13.500
NTSC-J	710 x 480	Interface	15.734	59.940	13.500
NTSC-JLH	720 x 480	Interface	15.734	59.940	13.500
NTSC-JSH	720 x 480	Interface	15.734	59.940	13.500
NTSC44	720 x 480	Interface	15.734	59.940	13.500
PAL-60	710 x 480	Interface	15.734	59.940	13.500
PAL-M	710 x 480	Interface	15.734	59.940	13.500
PAL-N	702 x 574	Interface	15.625	50.000	13.500
PAL#KA	768 x 574	Interface	15.625	50.000	14.750
PAL#	768 x 574	Interface	15.625	50.000	14.750
PAL	702 x 574	Interface	15.625	50.000	13.500
PAL-NC	720 x 574	Interface	15.625	50.000	13.500

Format	Active (HxV)	Scan	Horizontal Rate (kHz)	Vertical Rate (Hz)	Pixel Rate (MHz)
TEST25	640 x 480	Progressive	31.250	59.524	25.000

HDTV Formats

Format	Active (HxV)	Scan	Horizontal Rate (kHz)	Vertical Rate (Hz)	Pixel Rate (MHz)
720p23	1280 x 720	Progressive	17.982	23.976	74.176
720p24	1280 x 720	Progressive	18.000	24.000	74.250
720p25	1280 x 720	Progressive	18.750	25.000	74.250
720p29	1280 x 720	Progressive	22.478	29.971	74.177
720p30	1280 x 720	Progressive	22.500	30.000	74.250
720p50	1280 x 720	Progressive	37.500	50.000	74.250
720p59	1280 x 720	Progressive	44.955	59.940	74.175824
720p60	1280 x 720	Progressive	45.000	60.000	74.250
720p100	1280 x 720	Progressive	75.000	100.000	148.500
720p119	1280 x 720	Progressive	89.910	119.880	148.351648
720p120	1280 x 720	Progressive	90.000	120.000	148.500
1035i29	1920 x 1035	Interlace	33.716	59.940	74.175824
1035i30	1920 x 1035	Interlace	33.750	60.000	74.250
1080i25	1920 x 1080	Interlace	28.125	50.000	74.250
1080i29	1920 x 1080	Interlace	33.716	59.940	74.175824
1080i30	1920 x 1080	Interlace	33.750	60.000	74.250
1080i50	1920 x 1080	Interlace	56.250	100.000	148.500
1080i59	1920 x 1080	Interlace	67.433	119.880	148.351648
1080i60	1920 x 1080	Interlace	67.500	120.000	148.500
1080p23	1920 x 1080	Progressive	26.973	23.976	74.175824
1080p24	1920 x 1080	Progressive	28.125	24.000	74.250
1080p25	1920 x 1080	Progressive	28.125	25.000	74.250
1080p29	1920 x 1080	Progressive	33.716	29.970	74.175824
1080p30	1920 x 1080	Progressive	33.750	30.000	74.250
1080p50	1920 x 1080	Progressive	56.250	50.000	148.500
1080p59	1920 x 1080	Progressive	67.433	59.940	148.351648
1080p60	1920 x 1080	Progressive	67.500	60.000	148.500
1080s23	1920 x 1080	Interlace	26.973	47.952	74.175824
1080s24	1920 x 1080	Interlace	27.000	48.000	74.250
1080i25_	1920 x 1080	Interlace	31.250	50.000	72.000
1152iLA	960 x 1152	Interlace	31.250	50.000	36.000
1152iLA_	960 x 1152	Interlace	31.250	50.000	37.125
1152iLH	1920 x 1152	Interlace	31.250	50.000	72.000
1152iLH_	1920 x 1152	Interlace	31.250	50.000	74.250
1152iSH	1280 x 1152	Interlace	31.250	50.000	48.000
1152iSH_	1280 x 1152	Interlace	31.250	50.000	49.500
TEST81	1024 x 768	Progressive	61.738	77.173	81.000

VESA DMT Formats

Format	Active (HxV)	Scan	Horizontal Rate (kHz)	Vertical Rate (Hz)	Pixel Rate (MHz)
DMT0659	640 x 480	Progressive	31.469	59.941	25.1752
DMT0660	640 x 480	Progressive	31.500	60.000	25.200
DMT0672	640 x 480	Progressive	37.861	72.809	31.500
DMT0675	640 x 480	Progressive	37.500	75.000	31.500
DMT0685	640 x 480	Progressive	43.269	85.008	36.000
DMT0685D	640 x 400	Progressive	37.861	85.080	31.500
DMT0685F	640 x 350	Progressive	37.861	85.080	31.500
DMT0785H	720 x 400	Progressive	37.927	85.039	35.500
DMT0856	800 x 600	Progressive	35.156	56.250	36.000
DMT0860	800 x 600	Progressive	37.879	60.317	40.000
DMT0872	800 x 600	Progressive	48.077	72.188	50.000
DMT0875	800 x 600	Progressive	46.875	75.000	49.500
DMT0885	800 x 600	Progressive	53.674	85.061	56.250
DMT1043	1024 x 768	Interlace	35.522	86.957	44.899808
DMT1060	1024 x 768	Progressive	48.363	60.004	65.000
DMT1070	1024 x 768	Progressive	56.476	70.069	75.000
DMT1075	1024 x 768	Progressive	60.023	75.029	78.750
DMT1085	1024 x 768	Progressive	68.677	84.997	94.500
DMT1170	1152 x 864	Progressive	63.851	70.013	94.500
DMT1175	1152 x 864	Progressive	67.500	75.000	108.000
DMT1185	1152 x 864	Progressive	77.094	84.999	121.500
DMT1243G	1280 x 1024	Interlace	46.433	86.871	78.750
DMT1260A	1280 x 960	Progressive	60.000	60.000	108.000
DMT1260G	1280 x 1024	Progressive	63.981	60.020	108.000
DMT1275A	1280 x 960	Progressive	75.000	75.000	126.000
DMT1275G	1280 x 1024	Progressive	79.976	75.025	135.000
DMT1285A	1280 x 960	Progressive	85.938	85.002	148.500
DMT1285G	1280 x 1024	Progressive	91.146	85.024	157.500
DMT1648	1600 x 1200	Interlace	62.500	96.080	135.000
DMT1660	1600 x 1200	Progressive	75.000	60.000	162.000
DMT1665	1600 x 1200	Progressive	81.250	65.000	175.500
DMT1670	1600 x 1200	Progressive	87.500	70.000	189.000
DMT1675	1600 x 1200	Progressive	93.750	75.000	202.500
DMT1680	1600 x 1200	Progressive	100.000	80.000	216.000
DMT1685	1600 x 1200	Progressive	106.250	85.000	229.500
DMT1760	1792 x 1344	Progressive	83.640	60.000	204.750
DMT1775	1792 x 1344	Progressive	106.270	74.997	261.000
DMT1860	1856 x 1392	Progressive	86.333	59.995	218.250
DMT1875	1856 x 1392	Progressive	112.500	75.000	288.000
DMT1960	1920 x 1440	Progressive	90.000	60.000	234.000
DMT1975	1920 x 1440	Progressive	112.500	75.000	297.000
DMT2060	2048 x 1536	Progressive	95.820	60.000	239.933008
DMT2075	2048 x 1536	Progressive	120.450	75.000	319.915008

Format	Active (HxV)	Scan	Horizontal Rate (kHz)	Vertical Rate (Hz)	Pixel Rate (MHz)
SMT0660	640 x 480	Progressive	31.469	59.941	25.1752
SMT0660D	640 x 400	Progressive	31.469	59.941	25.1752
SMT0760H	720 x 400	Progressive	31.469	59.941	28.3221
SMT0760V	720 x 480	Progressive	31.469	59.941	28.3221

VESA CVT Formats

Format	Active (HxV)	Scan	Horizontal Rate (kHz)	Vertical Rate (Hz)	Pixel Rate (MHz)
CVR0660	640 x 480	Progressive	29.375	59.464	23.500
CVR0760	768 x 480	Progressive	29.634	59.866	27.500
CVR0860	800 x 600	Progressive	36.979	59.837	35.500
CVR0860H	848 x 480	Progressive	29.514	59.745	29.750
CVR0960D	960 x 600	Progressive	37.054	59.957	41.500
CVR1060	1024 x 768	Progressive	47.297	59.870	56.000
CVR1060H	1064 x 600	Progressive	36.969	59.820	45.250
CVR1160D	1152 x 720	Progressive	44.398	59.916	58.250
CVR1260	1280 x 960	Progressive	59.201	59.920	85.250
CVR1260D	1224 x 768	Progressive	47.327	59.907	65.500
CVR1260E	1280 x 768	Progressive	47.396	59.995	68.250
CVR1260G	1280 x 1024	Progressive	63.194	59.957	91.000
CVR1260H	1280 x 720	Progressive	44.444	59.979	64.000
CVR1360H	1360 x 768	Progressive	47.368	59.960	72.000
CVR1460	1400 x 1050	Progressive	64.744	59.948	101.000
CVR1560D	1536 x 960	Progressive	59.257	59.977	100.500
CVR1660	1600 x 1200	Progressive	74.006	59.924	130.250
CVR1660D	1680 x 1050	Progressive	64.674	59.883	119.000
CVR1760D	1728 x 1080	Progressive	66.605	59.950	125.750
CVR1760H	1704 x 960	Progressive	59.147	59.865	110.250
CVR1860H	1864 x 1050	Progressive	64.723	59.929	131.000
CVR1960	1920 x 1440	Progressive	88.822	59.974	184.750
CVR1960D	1920 x 1200	Progressive	74.038	59.950	154.000
CVR1960H	1920 x 1080	Progressive	66.587	59.934	138.500
CVR2060	2048 x 1536	Progressive	94.769	59.980	209.250
CVR2160H	2128 x 1200	Progressive	74.082	59.986	169.499984
CVR2360D	2304 x 1440	Progressive	88.778	59.945	218.750
CVR2460D	2456 x 1536	Progressive	94.706	59.940	247.750
CVR2560	2560 x 1920	Progressive	118.474	59.987	322.250016
CVR2560E	2560 x 1536	Progressive	94.761	59.975	257.750
CVR2560H	2560 x 1440	Progressive	88.787	59.951	241.500
CVR2760H	2728 x 1536	Progressive	94.789	59.993	273.750016
CVR3060D	3072 x 1920	Progressive	118.425	59.962	382.749984
CVR3260	3200 x 2400	Progressive	148.140	60.000	497.749984
CVR3460H	3408 x 1920	Progressive	118.484	59.992	422.749984

Format	Active (HxV)	Scan	Horizontal Rate (kHz)	Vertical Rate (Hz)	Pixel Rate (MHz)
CVR3860	3840 x 2880	Progressive	177.688	59.989	710.750016
CVR3860D	3840 x 2400	Progressive	148.125	59.994	592.499968
CVR4260H	4264 x 2400	Progressive	148.113	59.989	655.249984
CVR4660D	4608 x 2880	Progressive	177.695	59.992	847.249984
CVR5160H	5120 x 2880	Progressive	177.699	59.993	938.249984
CVT0650	640 x 480	Progressive	24.688	49.673	19.750
CVT0660	640 x 480	Progressive	29.688	59.375	23.750
CVT0675	640 x 480	Progressive	37.684	74.769	30.750
CVT0685	640 x 480	Progressive	42.892	84.600	35.000
CVT0750D	640 x 680	Progressive	24.740	49.778	23.749998
CVT0760D	768 x 480	Progressive	29.948	59.896	28.750002
CVT0775D	768 x 480	Progressive	37.654	74.710	36.750
CVT0785D	768 x 480	Progressive	42.843	84.502	42.500
CVT0850	800 x 600	Progressive	30.998	49.916	30.750
CVT0850H	848 x 480	Progressive	24.621	49.540	26.000
CVT0860	800 x 600	Progressive	37.654	59.861	38.250
CVT0860H	848 x 480	Progressive	29.826	59.659	31.500
CVT0875	800 x 600	Progressive	47.115	74.905	49.000004
CVT0875H	848 x 480	Progressive	37.684	74.769	41.000
CVT0885	800 x 600	Progressive	53.741	84.898	56.750
CVT0885H	848 x 480	Progressive	42.969	84.751	46.750
CVT0950D	960 x 600	Progressive	30.833	49.651	37.000
CVT0960D	960 x 600	Progressive	37.212	59.635	45.250
CVT0975D	960 x 600	Progressive	47.075	74.841	58.750
CVT0985D	960 x 600	Progressive	53.600	84.676	67.750
CVT1050	1024 x 768	Progressive	39.634	49.980	51.999996
CVT1050H	1064 x 600	Progressive	30.871	49.712	40.750
CVT1060	1024 x 768	Progressive	47.816	59.920	63.500
CVT1060H	1064 x 600	Progressive	37.352	59.859	50.500
CVT1075	1024 x 768	Progressive	60.294	74.900	82.000
CVT1075H	1064 x 600	Progressive	47.146	79.954	65.250
CVT1085	1024 x 768	Progressive	68.677	84.895	94.500
CVT1085H	1064 x 600	Progressive	53.750	84.913	75.250
CVT1150D	1152 x 720	Progressive	37.025	49.764	54.500
CVT1160D	1152 x 720	Progressive	44.859	59.972	66.750
CVT1175D	1152 x 720	Progressive	56.415	74.721	85.750
CVT1185D	1152 x 720	Progressive	64.453	84.918	99.000
CVT1250	1280 x 960	Progressive	49.405	49.853	83.000
CVT1250D	1224 x 768	Progressive	39.499	49.809	62.250
CVT1250E	1280 x 768	Progressive	39.593	49.929	65.249996
CVT1250G	1280 x 1024	Progressive	52.679	49.838	88.500
CVT1250H	1280 x 720	Progressive	37.071	49.827	60.500
CVT1260	1280 x 960	Progressive	59.699	59.939	101.250
CVT1260D	1224 x 768	Progressive	47.739	59.823	76.000
CVT1260E	1280 x 768	Progressive	47.776	59.870	79.500
CVT1260G	1280 x 1024	Progressive	63.668	59.895	109.000
CVT1260H	1280 x 720	Progressive	44.772	59.855	74.500

Format	Active (HxV)	Scan	Horizontal Rate (kHz)	Vertical Rate (Hz)	Pixel Rate (MHz)
CVT1275	1280 x 960	Progressive	75.231	74.857	130.000008
CVT1275D	1224 x 768	Progressive	60.191	74.771	97.750
CVT1275E	1280 x 768	Progressive	60.289	74.893	102.250
CVT1275G	1280 x 1024	Progressive	80.295	74.902	138.750
CVT1275H	1280 x 720	Progressive	56.456	74.777	95.750
CVT1285	1280 x 960	Progressive	85.793	84.859	148.250
CVT1285D	1224 x 768	Progressive	68.598	84.793	112.500
CVT1285E	1280 x 768	Progressive	68.633	84.837	117.500
CVT1285G	1280 x 1024	Progressive	91.456	84.839	159.500
CVT1285H	1280 x 720	Progressive	64.398	84.846	110.250
CVT1350H	1360 x 768	Progressive	39.564	49.892	69.000
CVT1360H	1360 x 768	Progressive	47.720	59.799	84.750
CVT1375H	1360 x 768	Progressive	60.288	74.891	109.000
CVT1385H	1360 x 768	Progressive	68.668	84.880	125.250008
CVT1450	1400 x 1050	Progressive	54.113	49.965	100.000
CVT1460	1400 x 1050	Progressive	65.317	59.978	121.750
CVT1475	1400 x 1050	Progressive	82.279	74.867	156.000
CVT1485	1400 x 1050	Progressive	93.881	84.960	179.500
CVT1550D	1536 x 960	Progressive	49.479	49.929	99.750
CVT1560D	1536 x 960	Progressive	59.670	59.910	121.250
CVT1575D	1536 x 960	Progressive	75.218	74.844	155.250
CVT1585D	1536 x 960	Progressive	85.817	84.884	178.500
CVT1650	1600 x 1200	Progressive	61.795	49.915	131.500
CVT1650D	1680 x 1050	Progressive	54.121	59.974	119.500008
CVT1660	1600 x 1200	Progressive	74.537	59.869	161.000
CVT1660D	1680 x 1050	Progressive	65.290	59.954	146.250
CVT1675	1600 x 1200	Progressive	94.095	74.976	204.750
CVT1675D	1680 x 1050	Progressive	82.306	74.892	187.000
CVT1685	1600 x 1200	Progressive	107.208	84.951	235.000
CVT1685D	1680 x 1050	Progressive	93.859	84.941	214.750
CVT1750D	1728 x 1080	Progressive	55.616	49.925	127.250
CVT1750H	1704 x 960	Progressive	49.507	49.957	110.500
CVT1760D	1728 x 1280	Progressive	67.134	59.941	155.749984
CVT1760H	1704 x 960	Progressive	59.739	59.979	135.250
CVT1775D	1728 x 1080	Progressive	84.653	74.914	197.749984
CVT1775H	1704 x 960	Progressive	75.240	74.865	172.750
CVT1785D	1728 x 1080	Progressive	96.514	84.884	226.999984
CVT1785H	1704 x 960	Progressive	85.856	84.922	198.500
CVT1850H	1864 x 1050	Progressive	54.051	49.909	132.750008
CVT1860H	1864 x 1050	Progressive	65.314	59.976	162.500
CVT1875H	1864 x 1050	Progressive	82.341	74.924	207.500016
CVT1885H	1864 x 1050	Progressive	93.849	84.931	238.000
CVT1950	1920 x 1440	Progressive	74.171	49.980	192.250
CVT1950D	1920 x 1200	Progressive	61.816	49.932	158.250
CVT1950H	1920 x 1080	Progressive	55.621	49.929	141.500
CVT1960	1920 x 1440	Progressive	89.532	59.968	233.500
CVT1960D	1920 x 1200	Progressive	74.556	59.885	193.250

Format	Active (HxV)	Scan	Horizontal Rate (kHz)	Vertical Rate (Hz)	Pixel Rate (MHz)
CVT1960H	1920 x 1080	Progressive	67.158	59.963	173.000
CVT1975	1920 x 1440	Progressive	112.879	74.953	298.000
CVT1975D	1920 x 1200	Progressive	94.038	74.930	245.250
CVT1975H	1920 x 1080	Progressive	84.643	74.906	220.750
CVT1985	1920 x 1440	Progressive	128.599	84.940	339.499968
CVT1985D	1920 x 1200	Progressive	107.184	84.932	281.249984
CVT1985H	1920 x 1080	Progressive	96.513	84.884	253.249984
CVT2050	2048 x 1536	Progressive	79.118	49.980	219.000
CVT2060	2048 x 1536	Progressive	95.446	59.654	267.250
CVT2075	2048 x 1536	Progressive	120.384	74.959	339.000
CVT2085	2048 x 1536	Progressive	137.182	84.943	388.500
CVT2150H	2128 x 1200	Progressive	61.794	49.914	175.000
CVT2160H	2128 x 1200	Progressive	74.633	59.516	213.750016
CVT2175H	2128 x 1200	Progressive	94.095	74.976	272.500
CVT2185H	2128 x 1200	Progressive	107.229	84.967	312.250016
CVT2350D	2304 x 1440	Progressive	74.179	49.986	230.249984
CVT2360D	2304 x 1440	Progressive	89.525	59.963	280.750016
CVT2375D	2304 x 1440	Progressive	112.847	74.932	357.500
CVT2385D	2304 x 1440	Progressive	128.612	84.948	409.500
CVT2450D	2456 x 1536	Progressive	79.066	49.947	262.500
CVT2460D	2456 x 1536	Progressive	95.465	59.966	320.000
CVT2475D	2456 x 1536	Progressive	120.346	74.935	407.249984
CVT2485D	2456 x 1536	Progressive	137.206	84.957	466.499968
CVT2550	2560 x 1920	Progressive	98.816	49.957	346.250016
CVT2550H	2560 x 1440	Progressive	74.146	49.964	256.250
CVT2560	2560 x 1920	Progressive	119.247	59.953	419.749984
CVT2560H	2560 x 1440	Progressive	89.521	59.961	312.250016
CVT2575	2560 x 1920	Progressive	150.408	74.979	534.249984
CVT2575H	2560 x 1440	Progressive	112.855	74.937	397.250016
CVT2585	2560 x 1920	Progressive	171.453	84.962	609.000
CVT2585H	2560 x 1440	Progressive	128.606	84.944	454.750016
CVT2750H	2728 x 1536	Progressive	79.108	49.973	291.750016
CVT2760H	2728 x 1536	Progressive	95.430	59.944	335.000
CVT2775H	2728 x 1536	Progressive	120.336	74.929	451.500
CVT2785H	2728 x 1536	Progressive	137.208	84.959	516.999968
CVT3050D	3072 x 1920	Progressive	98.819	49.959	414.250016
CVT3060D	3072 x 1920	Progressive	119.259	59.959	503.749984
CVT3075D	3072 x 1920	Progressive	150.376	74.963	640.000
CVT3085D	3072 x 1920	Progressive	171.465	84.968	732.500032
CVT3250	3200 x 2400	Progressive	123.528/	49.991	545.499968
CVT3260	3200 x 2400	Progressive	149.086	59.970	660.749952
CVT3275	3200 x 2400	Progressive	187.948	74.969	839.000
CVT3285	3200 x 2400	Progressive	214.230	84.978	959.749952
CVT3450H	3408 x 1920	Progressive	98.851	49.975	460.250016
CVT3460H	3408 x 1920	Progressive	119.294	59.977	559.250048
CVT3475H	3408 x 1920	Progressive	150.424	74.987	710.000
CVT3485H	3408 x 1920	Progressive	171.453	84.962	812.000

Format	Active (HxV)	Scan	Horizontal Rate (kHz)	Vertical Rate (Hz)	Pixel Rate (MHz)
CVT3850	3840 x 2880	Progressive	148.179	49.976	789.499968
CVT3850D	3840 x 2400	Progressive	123.537	49.995	794.250048
CVT3860	3840 x 2880	Progressive	178.845	59.975	955.750016
CVT3860D	3840 x 2400	Progressive	149.071	59.964	794.250048
CVT3875	3840 x 2880	Progressive	225.493	74.964	1212.249984
CVT3875D	3840 x 2400	Progressive	187.966	74.977	1007.500032
CVT3885	3840 x 2880	Progressive	257.048	84.975	1386.000
CVT3885D	3840 x 2400	Progressive	214.239	84.982	1151.750016
CVT4250H	4264 x 2400	Progressive	123.512	49.985	726.249984
CVT4260H	4264 x 2400	Progressive	149.061	59.960	881.250048
CVT4275H	4264 x 2400	Progressive	149.061	59.960	1117.250048
CVT4285H	4264 x 2400	Progressive	214.262	84.991	1277.000064
CVT4650D	4608 x 2880	Progressive	148.222	49.991	946.250048
CVT4660D	4608 x 2880	Progressive	178.850	59.976	1147.500032
CVT4675D	4608 x 2880	Progressive	225.496	74.966	1454.000
CVT4685D	4608 x 2880	Progressive	257.039	84.972	1661.500032
CVT5150H	5120 x 2880	Progressive	148.191	49.980	1052.749952
CVT5160H	5120 x 2880	Progressive	178.882	59.987	1276.499968
CVT5175H	5120 x 2880	Progressive	225.516	74.972	1616.499968
CVT5185H	5120 x 2880	Progressive	257.064	84.980	1846.750080

Game Formats

Format	Active (HxV)	Scan	Horizontal Rate (kHz)	Vertical Rate (Hz)	Pixel Rate (MHz)
240p2x_1	720 x 240	Progressive	15.734	60.055	13.500
240p2x_2	720 x 240	Progressive	15.750	60.115	13.5135
240p2x_3	720 x 240	Progressive	15.734	59.826	13.500
240p2x_4	720 x 240	Progressive	15.750	59.886	13.5135
240p2xL1	720 x 240	Progressive	15.734	60.055	13.500
240p2xL2	720 x 240	Progressive	15.750	60.155	13.5135
240p2xL3	720 x 240	Progressive	15.731	59.826	13.500
240p2xL4	720 x 240	Progressive	15.750	59.886	13.5135
240p2xS1	720 x 240	Progressive	15.734	60.055	13.500
240p2xS2	720 x 240	Progressive	15.750	60.155	13.5135
240p2xS3	720 x 240	Progressive	15.734	59.826	13.500
240p2xS4	720 x 240	Progressive	15.750	59.886	13.5135
240p4x_1	2880 x 240	Progressive	15.734	60.055	54.000
240p4x_2	2880 x 240	Progressive	15.750	60.115	54.054
240p4x_3	2880 x 240	Progressive	15.734	59.826	54.000
240p4x_4	2880 x 240	Progressive	15.750	59.886	54.054
240p4xL1	2880 x 240	Progressive	15.734	60.055	54.000
240p4xL2	2880 x 240	Progressive	15.750	60.115	54.054
240p4xL3	2880 x 240	Progressive	15.734	59.826	54.000

Format	Active (HxV)	Scan	Horizontal Rate (kHz)	Vertical Rate (Hz)	Pixel Rate (MHz)
240p4xL4	2880 x 240	Progressive	15.750	59.886	54.054
240p4xS1	2880 x 240	Progressive	15.734	60.055	54.000
240p4xS2	2880 x 240	Progressive	15.750	60.115	54.054
240p4xS3	2880 x 240	Progressive	15.734	59.826	54.000
240p4xS4	2880 x 240	Progressive	15.750	59.886	54.054
288p2x_1	720 x 288	Progressive	15.625	50.080	13.500
288p2x_2	720 x 288	Progressive	15.625	49.920	13.500
288p2x_3	720 x 288	Progressive	15.625	49.761	13.500
288p2xL1	720 x 288	Progressive	15.625	50.080	13.500
288p2xL2	720 x 288	Progressive	15.625	49.920	13.500
288p2xL3	720 x 288	Progressive	15.625	49.761	13.500
288p2xS1	720 x 288	Progressive	15.625	50.080	13.500
288p2xS2	720 x 288	Progressive	15.625	49.920	13.500
288p2xS3	720 x 288	Progressive	15.625	49.761	13.500
288p4x_1	2880 x 288	Progressive	15.625	50.080	54.000
288p4x_2	2880 x 288	Progressive	15.625	49.920	54.000
288p4x_3	2880 x 288	Progressive	15.625	49.761	54.000
288p4xL1	2880 x 288	Progressive	15.625	50.080	54.000
288p4xL2	2880 x 288	Progressive	15.625	49.920	54.000
288p4xL3	2880 x 288	Progressive	15.625	49.761	54.000
288p4xS1	2880 x 288	Progressive	15.625	50.080	54.000
288p4xS2	2880 x 288	Progressive	15.625	49.920	54.000
288p4xS3	2880 x 288	Progressive	15.625	49.761	54.000

Medical Formats

Format	Active (HxV)	Scan	Horizontal Rate (kHz)	Vertical Rate (Hz)	Pixel Rate (MHz)
DatRay5	2048 x 2560	Progressive	186.010	70.996	499.99488
DatRay6	2456 x 2560	Progressive	186.010	70.996	607.880704
DatRay7	2864 x 2560	Progressive	186.010	70.996	700.885696
DatRay8	3280 x 2560	Progressive	186.010	70.996	800.587008
DOM1266O	1200 x 1600	Progressive	109.752	66.316	186.140
DOM1570O	1536 x 2048	Progressive	147.183	70.423	357.950016
DOM1762O	1728 x 2304	Progressive	146.437	61.866	360.820
DOM1763O	1728 x 2304	Progressive	148.364	62.893	360.820
DOM1769O	1728 x 2304	Progressive	163.415	69.039	360.820
DOM1770X	1712 x 2100	Progressive	149.346	69.528	360.820
DOM2060_	2048 x 2048	Progressive	126.847	60.003	357.200
DOM2060Q	2048 x 2044	Progressive	127.769	60.382	360.820
DOM2065X	2048 x 2560	Progressive	169.891	65.092	500.159968
DOM2071X	2048 x 2560	Progressive	186.079	71.022	500.180032
DOM2076A	2048 x 1536	Progressive	118.691	75.599	360.820
DOM2076X	2048 x 2560	Progressive	199.449	76.009	542.500032

Format	Active (HxV)	Scan	Horizontal Rate (kHz)	Vertical Rate (Hz)	Pixel Rate (MHz)
DOM2365	2304 x 1728	Progressive	116.244	64.904	360.819968
DOM2569G	2560 x 2048	Progressive	144.722	69.014	500.160
DOM2571G	2560 x 2048	Progressive	150.289	71.703	500.160032
MATROX	1280 x 1024	Progressive	77.000	72.368	133.056
Md2	1200 x 1600	Progressive	124.430	75.504	214.019984
Md2SBX	1600 x 1200	Progressive	91.118	73.011	200.460
Md4SBX	1728 x 2304	Progressive	163.415	69.039	360.820
Md5SBV	2048 x 2560	Progressive	199.449	76.009	542.500032
Md5SBX	2048 x 2560	Progressive	186.012	70.997	500.000

Military Formats

Format	Active (HxV)	Scan	Horizontal Rate (kHz)	Vertical Rate (Hz)	Pixel Rate (MHz)
HOBO	752 x 482	Interlace	15.734	59.940	14.444056
LMC_1	640 x 480	Interlace	15.734	59.940	12.272727
LMC_2	640 x 480	Interlace	15.734	59.940	12.272727
LMC_3	640 x 480	Interlace	15.734	59.940	12.272727
LMC_4	640 x 480	Interlace	15.734	59.940	12.272727
MAVERIK	740 x 476	Interlace	15.734	59.940	14.318182
STANAGA	1244 x 842	Interlace	26.250	60.000	40.005
STANAGB	1560 x 574	Interlace	15.625	50.000	30.000
STANAGC	1262 x 484	Interlace	15.750	60.000	24.003
XGA2	720 x 400	Progressive	39.444	87.849	35.4996

TTL Formats

Format	Active (HxV)	Scan	Horizontal Rate (kHz)	Vertical Rate (Hz)	Pixel Rate (MHz)
AT&T_EVC	640 x 350	Progressive	25.862	59.866	24.000
AT&T_IVC	640 x 400	Progressive	25.862	59.866	24.000
AT&T_SVC	640 x 400	Progressive	25.862	59.866	24.000
CGA_m14	640 x 200	Progressive	15.700	59.924	14.3184
EGA_m2	640 x 350	Progressive	21.851	59.702	16.257144
HGC_text	720 x 350	Progressive	18.141	49.030	16.000362
HGCgraph	720 x 348	Progressive	18.519	50.051	16.000416
IBM_3164	640 x 400	Progressive	27.648	64.749	22.1184
IBM_3179	640 x 400	Progressive	25.560	60.000	20.488
MDA_m7	720 x 350	Progressive	18.432	49.816	16.257144

Misc. Formats

Format	Active (HxV)	Scan	Horizontal Rate (kHz)	Vertical Rate (Hz)	Pixel Rate (MHz)
CEA0659	640 x 480	Progressive	31.469	59.941	25.1752
EIA0629	640 x 480	Interlace	15.734	59.940	12.272727
EIA0629K	512 x 384	Interlace	15.734	59.940	12.272727
EIA0729	752 x 484	Interlace	15.734	59.940	14.318182
EIA0729X	752 x 484	Interlace	15.734	59.940	14.318182
ICS1160	1184 x 884	Progressive	55.200	60.000	83.0208
ICS1176	1184 x 884	Progressive	71.712	76.047	105.560504
ICS1660	1664 x 1248	Progressive	77.940	60.000	164.609296
ICS1676	1664 x 1248	Progressive	100.726	76.020	211.121888
ITU0725	768 x 574	Interlace	15.625	50.000	14.750
ITU0725K	640 x 480	Interlace	15.625	50.000	14.750
ITU0925X	920 x 574	Interlace	15.625	50.000	17.750
LD6Du60	1024 x 768	Progressive	48.364	60.005	65.001216
LD8Du75	1024 x 768	Progressive	60.023	75.029	78.750
NEC0656D	640 x 400	Progressive	24.823	56.416	21.050
NEC1140B	1120 x 750	Interlace	32.857	80.042	47.840004

Test Formats

Format	Active (HxV)	Scan	Horizontal Rate (kHz)	Vertical Rate (Hz)	Pixel Rate (MHz)
RAMP160	4096 x 480	Progressive	31.469	59.941	161.121280
TEST81	1024 x 768	Progressive	61.738	77.172	81.000
TEST150	2048 x 1024	Progressive	50.403	46.887	150.000
TEST165	1600 x 1200	Progressive	76.389	61.111	165.000
TEST250	2048 x 2048	Interlace	79.719	71.722	250.000016
TEST330	2048 x 1536	Progressive	94.178	59.269	330.000
tst300i	2048 x 1536	Interlace	94.178	118.538	299.86304
tst300p	2048 x 1536	Progressive	94.178	59.269	299.86304
tst360i	2816 x 1024	Interlace	97.000	91.037	360.064
tst360p	2816 x 1024	Progressive	97.000	91.080	360.064
tst400i	2816 x 1024	Interlace	97.000	91.037	399.640
tst400p	2816 x 1024	Progressive	97.000	91.080	399.640

Manufacturer Associated Formats

Format	Active (HxV)	Scan	Horizontal Rate (kHz)	Vertical Rate (Hz)	Pixel Rate (MHz)
APP0560	512 x 384	Progressive	24.480	60.147	15.667
APP0560B	560 x 384	Progressive	24.480	60.147	17.234
APP0629	640 x 480	Interlace	15.734	59.939	12.273
APP0629K	512 x 384	Interlace	15.734	59.939	12.273
APP0667_	640 x 480	Progressive	34.975	66.619	31.338
APP0667	640 x 480	Progressive	35.000	66.667	30.240
APP0675O	640 x 870	Progressive	68.850	75.000	57.283
APP0875	832 x 624	Progressive	49.107	75.087	55.000
APP1059	1024 x 768	Progressive	48.193	59.278	64.000
APP1075	1024 x 768	Progressive	60.241	74.927	80.000
APP1175	1152 x 870	Progressive	68.681	75.061	100.000
HWP1060	1024 x 768	Progressive	47.700	60.000	64.109
HWP1070	1024 x 768	Progressive	56.476	70.069	75.000
HWP1075	1024 x 768	Progressive	62.937	74.925	84.587
HWP1075_	1024 x 768	Progressive	60.241	75.020	80.000
HWP1260G	1280 x 1024	Progressive	63.338	59.979	108.181
HWP1272G	1280 x 1024	Progressive	78.125	72.005	135.000
HWP1275G	1280 x 1024	Progressive	79.976	75.024	134.999
IBM0660D	640 x 400	Progressive	30.296	59.638	24.964
IBM0660	640 x 480	Progressive	30.296	59.638	25.024
IBM0675	640 x 480	Progressive	39.375	75.000	31.500
IBM0770U	720 x 350	Progressive	31.469	70.087	28.322
IBM0770H	720 x 400	Progressive	31.469	70.087	28.322
IBM1043	1053 x 754	Interlace	35.414	86.906	45.542
IBM1043_	1056 x 768	Interlace	35.602	86.940	45.571
IBM1070	1024 x 768	Progressive	56.287	70.009	77.001
IBM1060Q	1024 x 1024	Progressive	63.360	60.000	89.211
IBM1076	1024 x 768	Progressive	61.080	75.782	86.001
IBM1260G	1280 x 1024	Progressive	63.363	60.003	111.519
IBM1267G	1280 x 1024	Progressive	70.755	67.003	120.000
IBM1267_	1280 x 1024	Progressive	70.755	67.003	120.000
IBM1352	1360 x 1024	Interlace	56.469	102.952	102.999
SNY1072	1024 x 768	Progressive	57.870	71.799	75.000
SNY1274G	1280 x 1024	Progressive	78.855	74.112	135.000
SNY1276G	1280 x 1024	Progressive	81.207	76.179	140.001
SUN1061Q	1024 x 1024	Progressive	65.267	61.399	92.940
SUN1077	1024 x 768	Progressive	62.040	77.068	84.374
SUN1166X	1152 x 900	Progressive	61.796	65.951	92.941
SUN1166_	1152 x 900	Progressive	61.846	66.004	94.501
SUN1176X	1152 x 900	Progressive	71.713	76.048	105.562
SUN1176_	1152 x 900	Progressive	71.809	76.150	108.001
SUN1267G	1280 x 1024	Progressive	71.722	66.718	117.050
SUN1267_	1280 x 1024	Progressive	71.678	66.677	118.125

Format	Active (HxV)	Scan	Horizontal Rate (kHz)	Vertical Rate (Hz)	Pixel Rate (MHz)
SUN1276G	1280 x 1024	Progressive	81.130	76.107	135.000
SUN1667G	1600 x 1280	Progressive	89.286	66.931	200.001
VSC1260G	1280 x 1024	Progressive	63.896	59.996	107.856
VSC1460	1440 x 1080	Progressive	67.080	60.000	129.867
VSC1660V	1680 x 1080	Progressive	67.080	60.000	151.332
VSC1875V	1868 x 1200	Progressive	93.975	75.000	240.576
VSC1960H	1920 x 1080	Progressive	67.080	60.000	172.798
VSC1975H	1920 x 1080	Progressive	84.060	75.000	220.637
VSC1975D	1920 x 1200	Progressive	93.975	75.000	246.590

Index

Numerics

3D feature [278](#)

A

Active Format Description [306](#)
alternate image versions [50](#)
analog component video SDTV (CE) CRTs [61](#)
analog composite video [58](#)
analog computer (IT) CRTs [52](#)
audio clips [298](#)
audio image [298](#)
AuxTest composite test image [74](#)

B

Backing up the current files on the file server [152](#)
Basic mode [15](#)
bitmap images [237](#)
boot a generator that is in a stalled state [119](#), [120](#)
boot a stalled generator from a different host [122](#)
boot device [14](#)
BootDev [119](#)
Booting a generator from the file server [148](#)
Booting up the generator [14](#)
BootNow [15](#), [120](#), [121](#)
Browse mode [15](#)
Browsing other media [16](#)
Bus commands [167](#)
bypass hot plug formats [44](#), [273](#)

C

cached images [72](#)
calibrate all frequencies [88](#)
calibration factors [88](#)
CEC test [74](#)
centering [54](#), [56](#), [60](#), [63](#), [66](#), [68](#), [70](#)
clone a generator using the Generator FTP Browser [125](#)
Cloning a generator using the PC card [124](#)
Cloning generators using the Generator FTP Browser [155](#)
CMD (Command) Terminal [22](#)
color component values [239](#)
command line interface [30](#)
Completion handshake [164](#)

Compliance Controller [345](#)
Component high definition television formats [47](#)
Component SDTV formats [46](#)
Component television format names [172](#)
component values [239](#)
component video [61](#), [64](#), [69](#)
Composite television formats [46](#)
composite test image [74](#)
composite video SDTV [58](#)
computer (IT) CRTs [52](#)
computer (IT) FPDs [55](#)
Computer display format names [173](#)
Computer display formats [47](#)
Configuring a file server [137](#)
Configuring format parameters [177](#)
Configuring special sync for FS, LS, or CS [395](#)
Configuring the generator's serial port [30](#)
Configuring the probe feature [391](#)
Connecting a generator directly to a PC [115](#)
Connecting generators to the network [142](#)
Content list [231](#)
Controlling a generator remotely [151](#)
Controlling the probe [394](#)
Copying files between generators [27](#)
Copying files between the generator's flash memory and PC card [26](#)
Copying files from a generator to a PC [25](#)
Copying files from a PC to a generator [23](#)
Copying files to the PC file server [153](#)
Copying the new files to each generator [154](#)
create a format catalog with both custom formats and default formats [225](#)
create a new format [217](#)
Creating a new format using the Format Editor [217](#)
Creating a test sequence [256](#)
Creating an image catalog [241](#)
Creating custom formats using the command line interface [222](#)
Creating format catalogs [224](#)
custom formats [222](#)
custom formats appear in the Source list [223](#)
custom images [234](#)

D

delete a user profile [37](#)
Deleting a test sequence [263](#)
Deleting an image catalog [245](#)
Deleting format catalogs [225](#)
DHCP [143](#), [145](#)
digital component video HDTV (CE) FPDs [64](#), [69](#)

digital computer (IT) FPDs [55](#)
display size [42](#)
Dolby audio [298](#)
DTS audio [298](#)

E

EDID compliance [330](#)
EDID Editor Tool [352](#)
EDID Formats [351](#)
EDID test [74](#)
Editing a test sequence [260](#)
Editing images [236](#)
Editor Tool [352](#)
Emulate mode [44](#), [274](#)
Establishing a Telnet session [33](#)
Establishing a terminal session [30](#)
ETHERNET connector [7](#)
external audio source [299](#)

F

file server [137](#)
file server IP address [146](#)
File server specifications [137](#)
file system [13](#), [136](#)
focus [54](#), [59](#), [62](#)
Format Editor [184](#)
format library [46](#)
format naming conventions [46](#)
format parameters [177](#)
Front panel interface [9](#)
FTP Browser [23](#)
FTP server [137](#)
function keys [18](#)

G

Generator file system [13](#), [136](#)
Generator FTP Browser [23](#)
Generator media [13](#)
Generator operational modes [14](#)
generator's function keys [18](#)
generator's path [17](#)
geometry [53](#), [59](#), [62](#)
GPIB connector [7](#)
GPIB port address [159](#)

H

HDCP [379](#)

HDCP test [74](#)
HDMI 1.4 3D displays [278](#)
HDMI compliance [330](#)
HDMI displays [276](#)
HDMI testing [271](#)
HDMI video pixel repetition [285](#)
high voltage regulation [54](#), [60](#), [63](#)
HostName [122](#)
hot plug bypass [44](#), [274](#)
HP Bypass [44](#), [274](#)

I

Image Cache [72](#)
image component values [239](#)
image options [231](#)
image rendering [72](#)
Image Shift Utility [69](#)
image versions [50](#), [231](#)
increment the color component values [239](#)
indicators [9](#)
InetAddr [123](#)
InfoFrame contents [302](#)
interface [41](#)
interfaces [4](#)
IP address [143](#), [146](#)

J

Java Runtime Environment [20](#), [151](#)

L

Library folder [13](#)
Lipsync
 testing display (sink) device [313](#)
luminance [54](#), [56](#), [59](#), [62](#), [65](#), [68](#), [70](#)

M

Maintaining the generator's file system [151](#)
menu items [10](#)
Menu selection keys [10](#)
Modifying EDID [326](#)
modifying existing formats [184](#)
modifying format parameters [181](#), [182](#)
modifying image options [231](#)
multiple commands [163](#)

N

network interface [33](#)

O

- operate a generator remotely [151](#)
- Operating special sync for probe pulse [391](#)
- Operating the generator remotely through the command line interface [151](#)
- operational modes [14](#)
- operational status [9](#)
- Options key [11](#)

P

- path [17](#)
- path parameter [18](#)
- persistence [57, 66, 68, 70](#)
- photometry [53, 56, 59, 62, 65, 68, 70](#)
- physical connections [40](#)
- pixel anomalies [56, 66, 68, 70](#)
- pixel repetition [285](#)
- Probe coordinate numbering [391](#)
- probe feature [391](#)
- probe pulse [391](#)
- profiles [36](#)
- Programming the generator's function keys [18](#)

R

- Reading EDID [43, 273](#)
- Reboot the generators [154](#)
- regulation [54, 60, 63](#)
- re-initialize the generator using the command line [128](#)
- Removing current files from the generators [154](#)
- render images quickly [72](#)
- report for the EDID [304, 324, 342](#)
- resolution [54, 56, 59, 62, 66, 68, 70](#)
- Running a test sequence [253](#)
- Running an HDCP self-test [386](#)

S

- select the device type [41](#)
- select the interface [41](#)
- Selecting a boot device [14](#)
- Selecting a user profile [36](#)
- Selecting images [47](#)
- Selecting menu items [10](#)
- selection keys [10](#)
- self-calibrate the generator [87](#)
- Sending multiple commands and queries per line [163](#)
- sequence XML file [260](#)
- Serial (RS-232) interface [30](#)

- SERIAL connector [7](#)
- Setting image component values [239](#)
- Setting the file server IP address in the generator [145](#)
- Setting the generator's IP address [143](#)
- Setting the generator's path [17](#)
- Setting the GPIB port address [159](#)
- setting up new users [36](#)
- Setting up the generator for HDMI testing [271](#)
- Settings key [12](#)
- Sharing objects on a file server [149](#)
- Sink key [43, 44, 273, 274, 350](#)
- soft key [10](#)
- Source list [43, 273](#)
- Source list of formats [176](#)
- special sync [391](#)
- Status byte [165](#)
- Status indicators [9](#)
- Status queries and control [165](#)
- System folder [13](#)

T

- television format names [171](#)
- Telnet session [33](#)
- test luminance [54, 56](#)
- test sequence list [251](#)
- test sequence XML file [260](#)
- Testing analog component video SDTV (CE) CRTs [61](#)
- Testing analog composite video SDTV (CE) CRTs [58](#)
- Testing analog computer (IT) CRTs [52](#)
- Testing digital component video HDTV (CE) FPDs [64](#)
- Testing digital computer (IT) FPDs [55](#)
- Testing DVI displays with HDCP [379](#)
- Testing EDID for HDMI compliance in HDMI [330, 352, 374](#)
- testing focus [54, 59, 62](#)
- testing for centering [54, 56, 60, 63, 66, 68, 70](#)
- testing for high voltage regulation [54, 60, 63](#)
- testing for persistence [57, 66, 68, 70](#)
- testing for pixel anomalies [56, 66, 68, 70](#)
- testing geometry [53, 59, 62](#)
- Testing HDMI displays [276](#)
- Testing HDMI displays with HDCP [381](#)
- testing luminance [59, 62, 65, 68, 70](#)
- testing photometry [53, 56, 59, 62, 65, 68, 70](#)
- testing resolution [54, 56, 59, 62, 66, 68, 70](#)
- Testing with Active Format Description [306](#)

U

- upgrade a generator [109](#)

Upgrade options and procedures [152](#)
upgrade procedures [152](#)
Upgrading generators over a network [152](#)
user profiles [36](#)

V

video formats [43](#), [272](#)
Video interfaces [2](#)
view analog calibration factors [88](#)
Viewing and modifying format parameters [177](#), [181](#), [182](#)
Viewing EDID from a display [330](#)
Viewing image versions [231](#)
Viewing InfoFrame contents [302](#)
Viewing the Content list of images [231](#)
Viewing the test sequence list [251](#)
Virtual Front Panel [20](#), [151](#)
voltage regulation [54](#), [60](#), [63](#)

W

Web interface [20](#)
Web server [20](#)